

SOUTHWEST SOLUTIONS GROUP
business efficiency systems

serious storage

www.southwestsolutions.com

Toll Free 1-800-803-1083



serious
storage

When you are at work, you need somewhere to store your stuff. Whether it's for an hour, a day or months, you need storage that is appropriate, accessible and secure. That's where we come in.

Office Specialty is the leader in workspace storage and filing solutions. For 125 years, we have designed and manufactured products with storage efficiency, functional flexibility, design versatility and enduring value. What we store has changed over the decades, and so have our storage solutions. Storage is no longer an afterthought in workspace planning - it is central to good design. Today we make it easier than ever to design uncluttered, beautiful workspaces.

- 2 What do you store?
- 4 Design freedom
- 8 Planning storage
- 10 Plan with Storwal
- 14 Plan with Planna
- 18 125 years of organizing offices
- 20 Sustainability built in

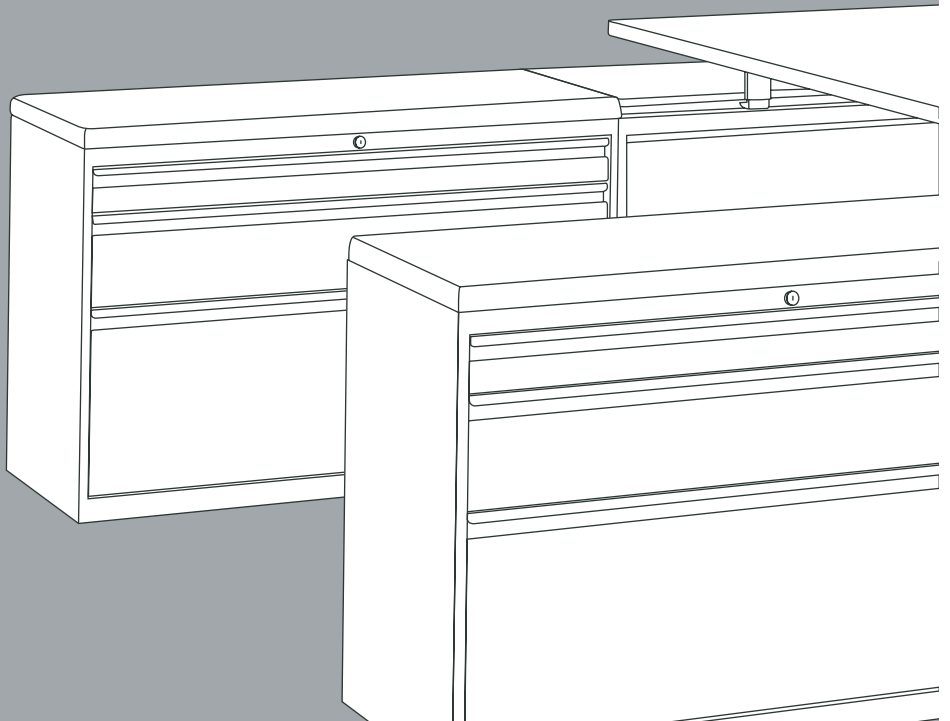

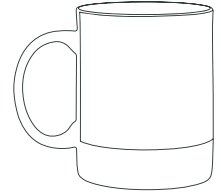
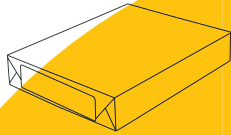
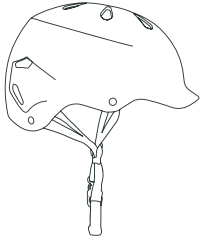
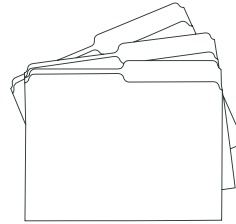
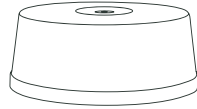

what do you store?

The stuff we need to make each day successful is changing. Today, items like smart devices, laptops, bike helmets, yoga mats can be more prevalent in the workplace than pencils and files. We carry our day with us. It makes sense to consider storage when you begin design work, not after.

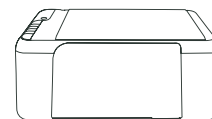
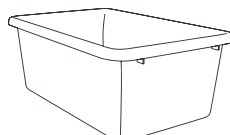
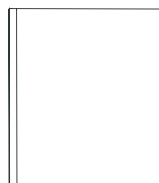
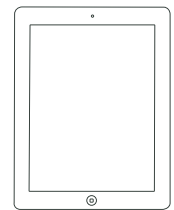
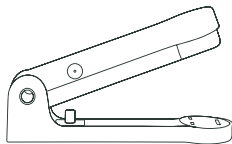
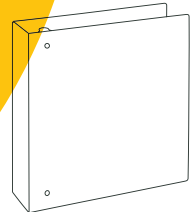
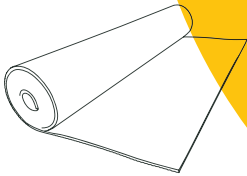



Storage that works

By offering the industry's widest selection of freestanding storage, we make it easy to provide solutions for what people really store in their workspace. Our products' steel construction, timeless design and unrivalled quality ensure enduring value for clients.

Customization is standard

Office Specialty offers many unique and innovative solutions for shared or multi-user workplace environments. Specialized products like Cubbi-Stor™ (individual locker storage) and Secure File (for high security materials) effectively meet specific needs anywhere in the office.

Why does storage matter?



It's no longer about paper and files

What we store has changed!



Storage can multi-task

It can carry power and data, support workspaces, serve as whiteboards and more!



European Trends

Storage as space division

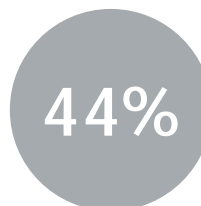

44%

The average we spend on storage in a workstation layout



design freedom

By offering the widest range of functional and aesthetic options in the industry, we make it easier for you to create distinctive design and customized solutions for your clients. Storage that stands out or blends in – it's up to you.



10
front styles

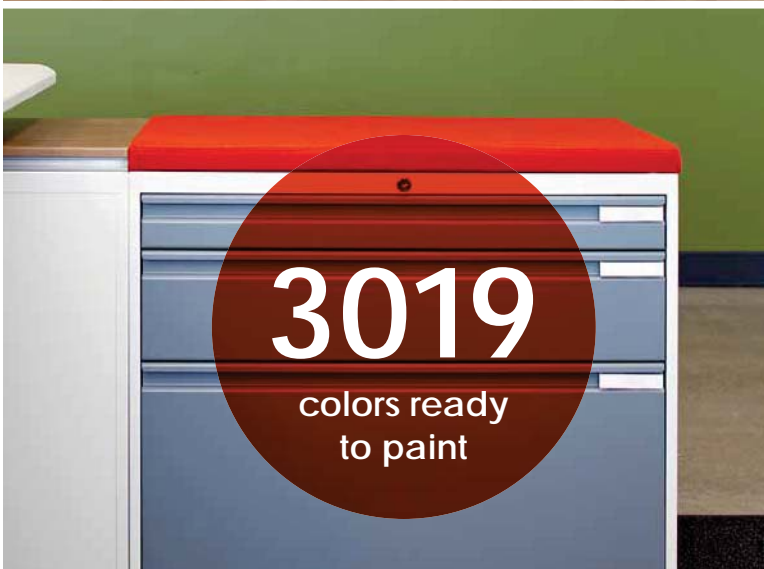

3019
colors ready
to paint



We match
any color



2897
pre-configured
cabinets



11
pull styles



189

specialty
cabinets



42

case heights



planning storage

Thinking about storage first is a smarter way to plan workspaces – whether you are trying to reduce your footprint, personalize storage, improve ergonomics or update an existing space.

Our planning storage includes Storwal and Planna, two unique product lines that offer innovative approaches to office design. Both can integrate with existing systems products to refresh a floor plan, or provide a planning platform for a completely new workspace solution.

1

Integrate & unify.

Combine our products with any system – new or existing. Match heights and finishes to unify the space. Save 50% of the workstation cost while reusing valuable existing components.

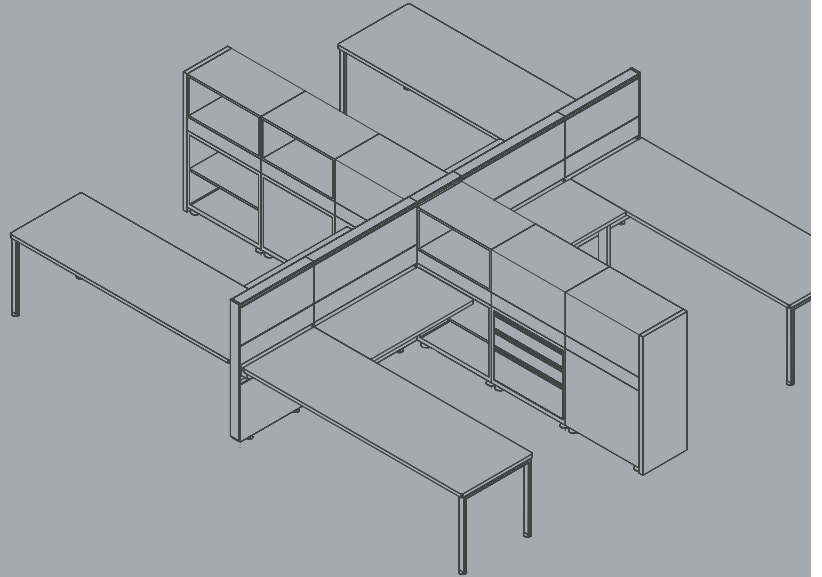

2

Save space. Save money.

Efficient design means you use up to 25% less space. Storage spine planning reduces the workstation footprint, increases storage and reduces components required. Use that extra space for future growth or for a new collaborative area.

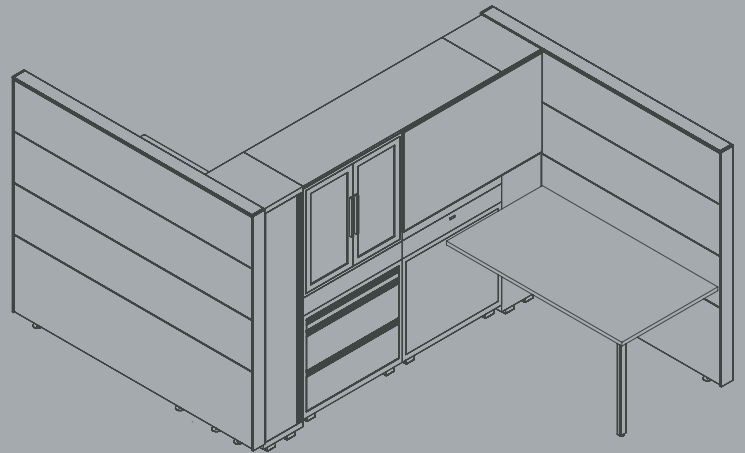

3

Be unique.

Planning with storage is not a conventional way of approaching design, but the advantages are obvious to those in the know.

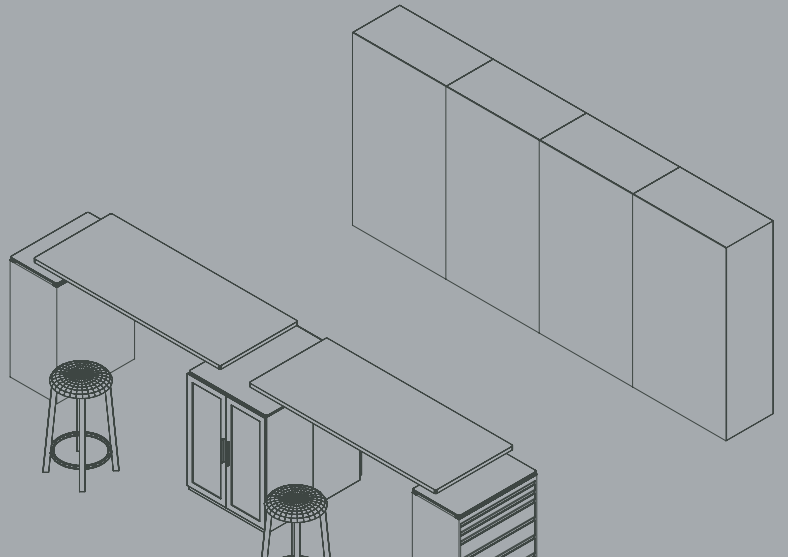



plan with storwal

Storwal is an electrified storage solution that gives you more space, more storage and fewer parts to manage.

Storwal's stackable, reversible storage elements can be integrated with any manufacturers' panel systems to create highly efficient and productive workspaces.

From open plans to private offices, touchdown stations to team areas, Storwal is a great way to organize people and optimize space.





Use Storwal as the spine in open planning to create a storage zone between workstations, or use it as a wing wall to create paired groups or an anchored line of privacy.

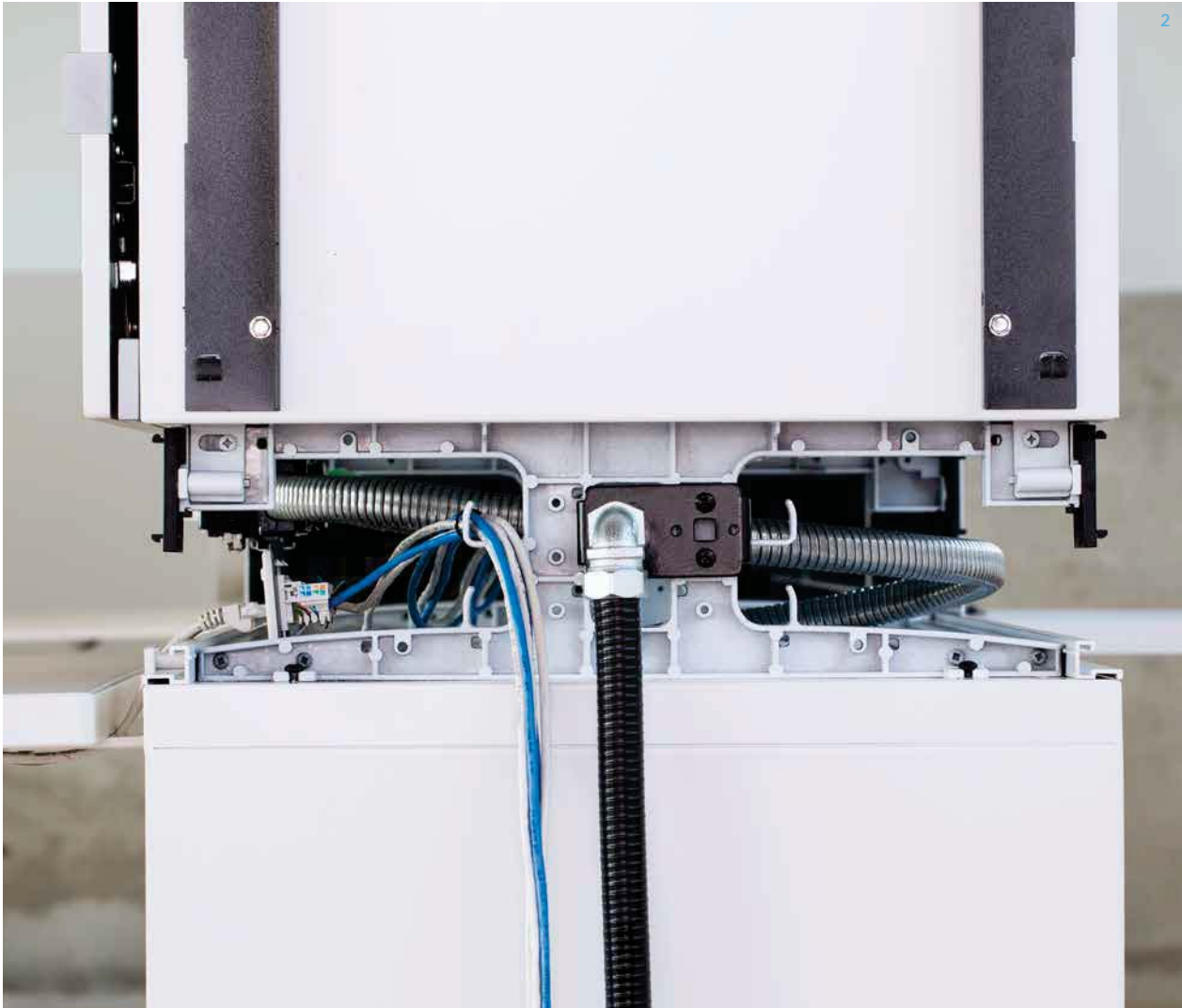





- 1** Worksurface brackets allow surfaces to be mounted at any point along the continuous rail.
- 2** Fully concealed electrical and data zone with full lay-in for data cables and easy-connect electrical.
- 3** Easy access, desk-height electrical and multiple storage options.
- 4** Integrates with any systems panels.

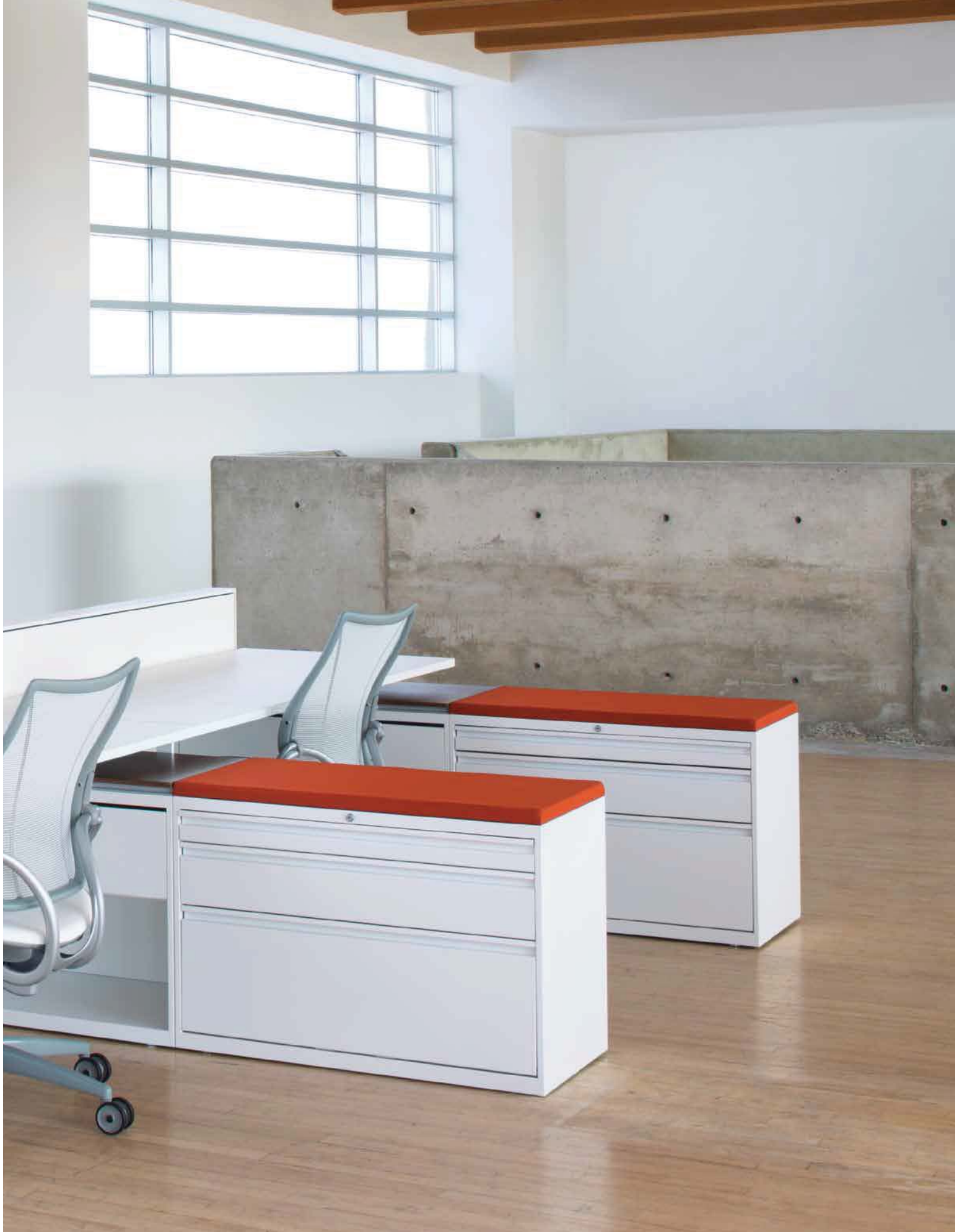

plan with planna

Adaptable, flexible and beautiful, Planna works in virtually any area of the office – from private offices to workstations and collaboration zones. Planna's off-module tops float above its low profile storage. Multipurpose cases can double as storage and seating.





Planna offers ample opportunity to customize your workplace, with the industry's broadest range of functional and aesthetic options.

1

Consider Planna in your open office design.

2

Planna offers creative and sophisticated options for private office applications.

3

Cushioned tops provide extra seating and add a pop of color.

4

Our paint options lead the industry and let you get creative with storage.





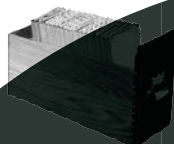

125 years of organizing offices

Founded as Office Specialty™ in 1888 in Rochester, New York, the company forged an early reputation for reliable, high quality filing and storage products. Expanding our offerings while maintaining top quality design and manufacturing standards, Office Specialty grew steadily throughout the 20th century.

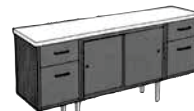



1888: getting organized for success

That 1888 was a leap year doesn't seem surprising given the significant strides occurring on all sections of the map. In Washington, the National Geographic Society was forming and Susan B. Anthony was organizing a congress for women's rights. Up the coast, George Eastman was registering the name Kodak while finalizing a patent for his newfangled camera. In Brazil, the final remnants of slavery were at long last being eradicated.

And in the thriving port of Montreal, a small office was being established for the selling of office furniture and supplies. This office represented the first foray into the Canadian market for a Rochester-based company called Office Specialty Manufacturing Company Limited, whose purpose, though basic, was quickly gaining value. Two industrial revolutions had shown people

the importance of productivity, and the company from Rochester was highlighting an equally vital principle: to be productive, you need to be organized. Amid a world suddenly flooded with order forms, shipping slips and invoices, companies were quickly coming to recognize the difference a few good filing cabinets could make.

Later in the year, Office Specialty opened another sales office in the burgeoning industrial center and cultural mosaic of Toronto, whose bustling economy and favorable location helped position the company to serve a broader customer base. Today, Office Specialty continues to help businesses get organized for success.

Our products are level 2, GREENGUARD and Cradle-to-Cradle certified, and almost 100% recyclable. Our commitment to level® certification reflects our belief that sustainability is defined by multiple perspectives, including a company's social actions, energy usage, material selection and human and ecosystem health impacts.

Equally important, our products are built to last and are completely reconfigurable so they can adapt as workspace needs change.

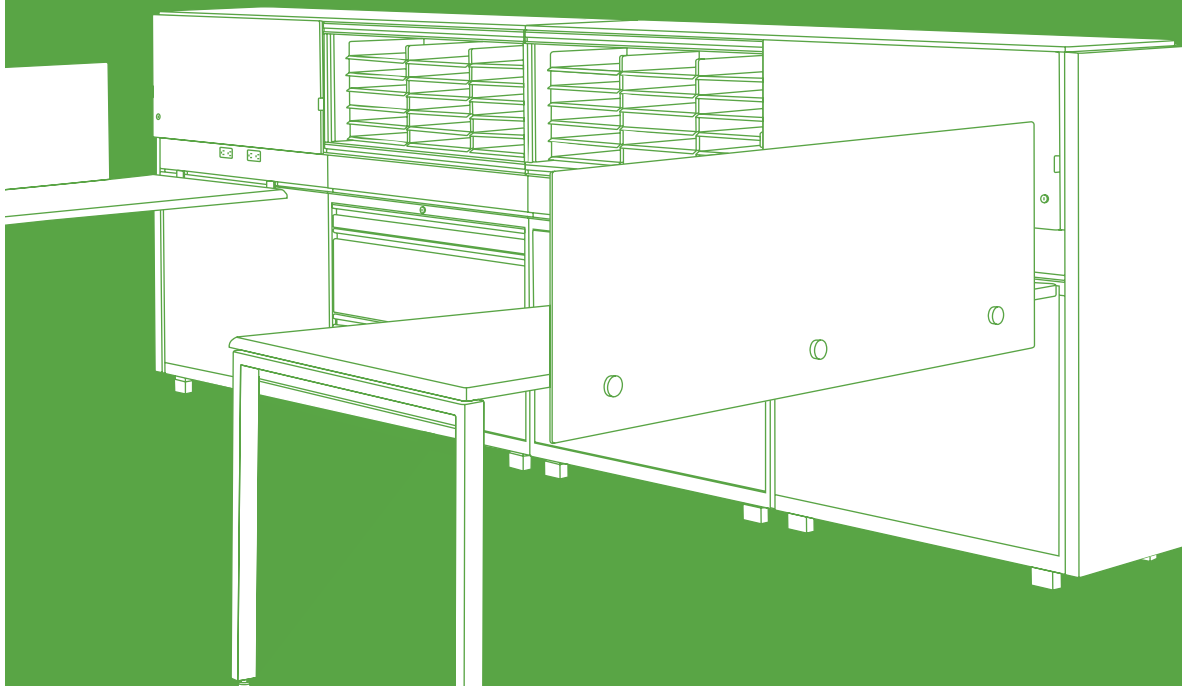



sustainability
built in

