

TIMES-2 PLANNING GUIDE



NOTES

TIMES-2 ROTARY CABINETS

Times-2 Rotary Cabinets are locking, double-depth, modular storage cabinets designed to occupy less floor space than traditional lateral files and store more types of media. Times-2 provides up to three times the capacity of standard lateral files and is far more versatile.

Times-2 Rotary Cabinets are manufactured with the highest quality materials and the most advanced engineering features of any storage system available on the market.

This comprehensive guide is divided into a review of types of units, a vertical planning guide for accessories and options, and space planning suggestions for Times-2. This information will help you plan and outfit Times-2 to meet your unique storage requirements.

With Times-2 Rotary Cabinets You Can Store:

- Small Electronics
- Binders
- Books
- CD/DVDs
- Personal Items – Coats, Purses, Running Shoes
- Files – Top Tab, End Tab, or Hanging Files
- Office Supplies
- Small Office Equipment
- Pharmaceuticals
- Weapons (Legal/A4-Size Times-2 only)
- Traffic and Parking Tickets
- Confiscated Drug, Jewelry, and Cash Evidence



TABLE OF CONTENTS

TIMES-2 DIMENSIONS	1
FEATURES AND BENEFITS	
Capacity	2
Access, Modular Design, Flexibility	3
Security, Aesthetics and Environmental Benefits	4
Cost Savings, Safety	5
Warranty	6
TIMES-2 UNITS	
Standard Units, RN Units	7
FN Units, Empty Units	8
Vertical Planning Instructions	9
ACCESSORIES	
Electronic Keypad Lock, Adjustable Reversible Shelf, Recessed Shelf	10
Reference Shelf, Dividers	11
Magnetic Followers, Rollout Drawer with Hanging Folder Frame, Rollout Drawer	12
End Supports, Multipurpose Filing Drawer, Hanging Folder Rail Set, Conversion of Rollout Drawers	13
Hanging Folder Frame, Rollout Hanging Folder Frame, Accessory Drawer	14
Converter Bars, Converter Insert, Security Drawer, Tub Drawer.	15
Finger Print Card Drawer Insert, Parking Ticket Drawer Insert, Wardrobe Kit	16
Pass Through Center Panel, Conversion Kits.	17
Wall Closing Strips and Extended Canopy Top.	18
Magnetic Dry Erase Door Overlays, Magnetic Fabric Door Overlays	19
Caster Kit, Quik-Panel Slat Wall	20
Miscellaneous Accessories	21
Weapons Accessories for Legal/A4-Size Units.	22-24
Structural Weight Issues.	25
SPACE PLANNING	
Next-to-Wall or Panel, Back-to-Back	26
Room Divider, Through-the-Wall or Panel	27
Built-in Alcove, Collaboration Table	28
Interconnect, Closed-Back Units.	29
Shared Benching Workstations	30
Filing Inch / Square Footage Comparison Chart	31

DIMENSIONS

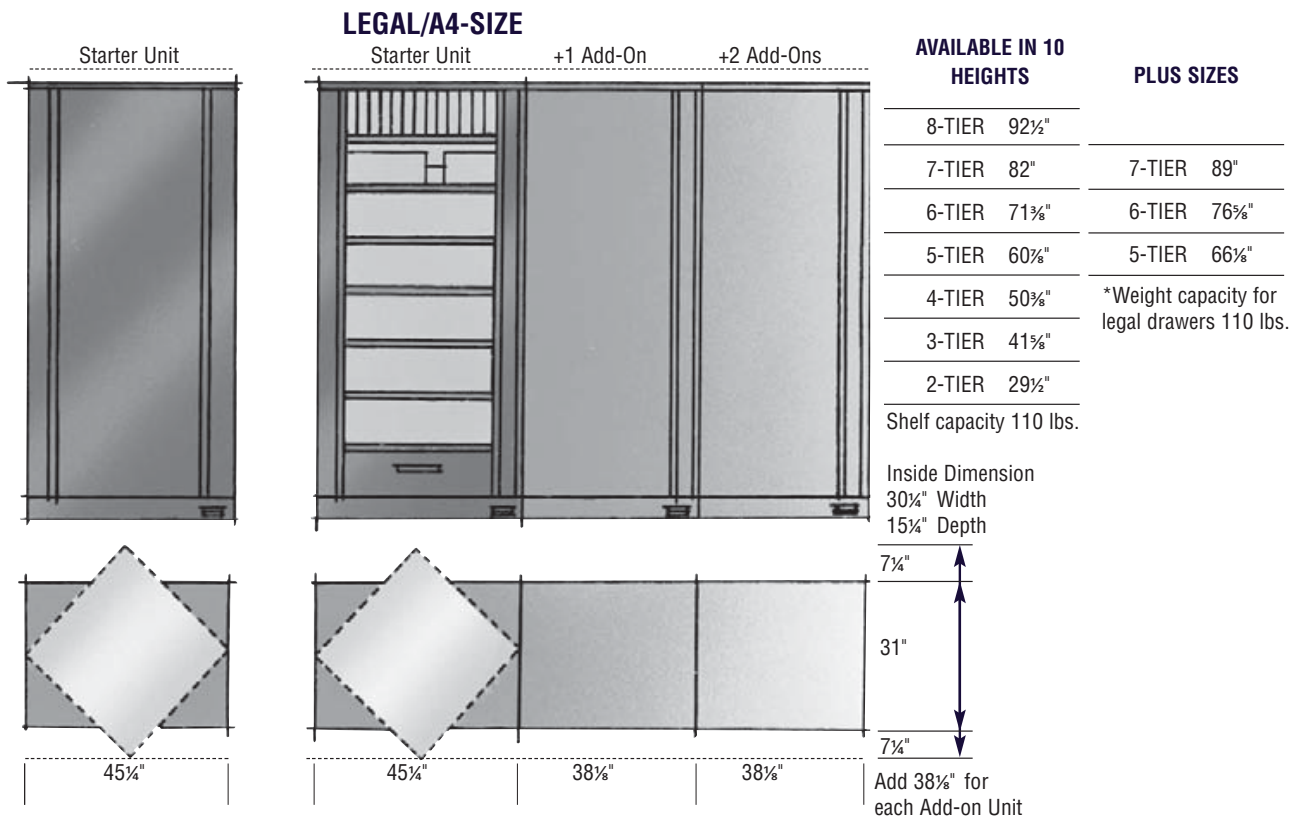
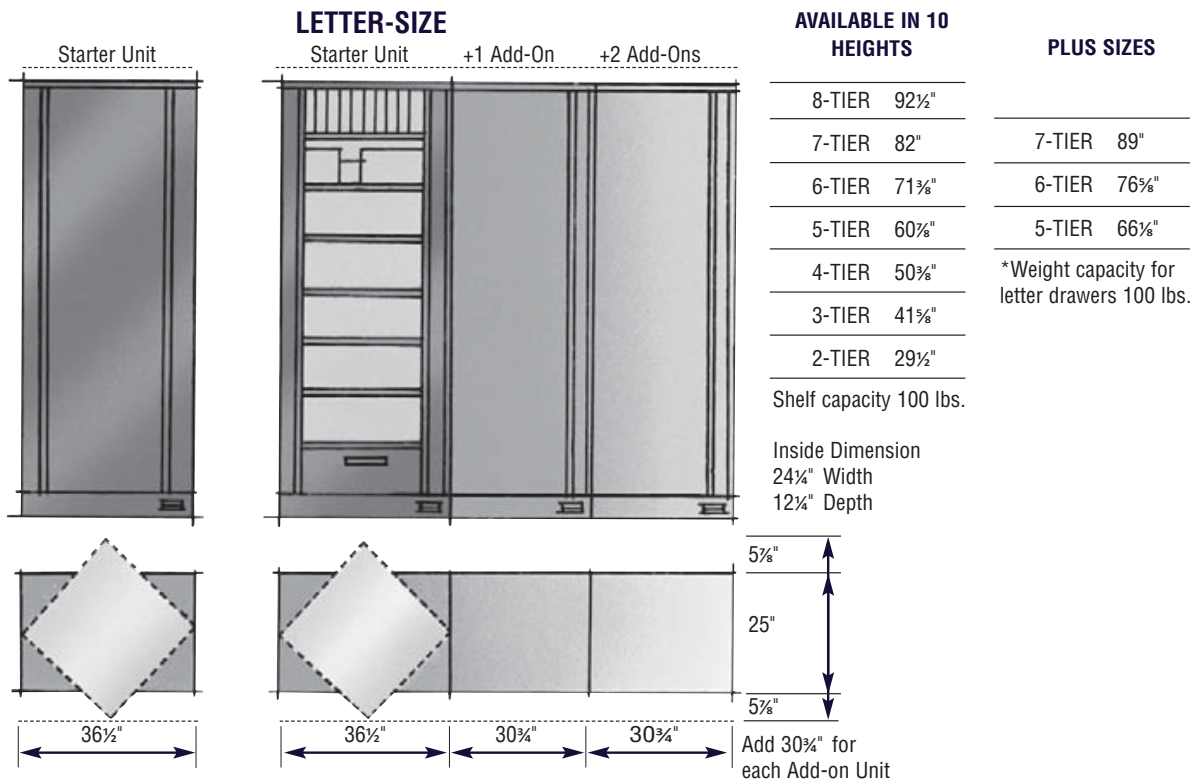

FEATURES AND BENEFITS

Times-2 is the more modern solution for your storage and filing needs. Times-2 Rotary Cabinets deliver significant features and benefits beyond traditional lateral files. The broad range of features and benefits includes increased capacity, improved versatility and significant cost savings.

Capacity

The unique back-to-back, double-depth design of Times-2 Rotary Cabinets allows you to store significantly more material in half the floor space of standard lateral or vertical files. A single 8-Tier unit holds as much as three standard lateral files in a footprint that is fifty percent smaller.

LETTER-SIZE			
Model #	Filing Inches	Vertical Cabinets	Lateral Cabinets
121S or 121A	96 LFI	.96	.75
131S or 131A	144 LFI	1.44	1.12
141S or 141A	192 LFI	1.92	1.50
151S or 151A	240 LFI	2.40	1.87
161S or 161A	288 LFI	2.88	2.25
171S or 171A	336 LFI	3.36	2.62
181S or 181A	384 LFI	3.84	3.00

LEGAL/A4-SIZE			
Model #	Filing Inches	Vertical Cabinets	Lateral Cabinets
221S or 221A	120 LFI	1.20	.92
231S or 231A	180 LFI	1.80	1.40
241S or 241A	240 LFI	2.40	1.87
251S or 251A	300 LFI	3.00	2.34
261S or 261A	360 LFI	3.60	2.81
271S or 271A	420 LFI	4.20	3.28
281S or 281A	480 LFI	4.80	3.75



The charts above show the capacity of each model Times-2 and the comparison to four drawer lateral and vertical cabinets. The chart doesn't tell the full story.

A conventional drawer file stores a maximum of 35 LFI per square foot of floor space. Times-2 will house up to 72 LFI per square foot. The gain in capacity combined with increased accessibility and real estate savings on floor space add up to great cost savings annually.

FEATURES AND BENEFITS

Access

The rotating design of Times-2 means that half the stored material is available for immediate access. The other half is a simple spin away. When Times-2 is placed between two work stations collaborative access is possible.

Times-2 can be installed in the "free spin" position for ADA compliance. Alternatively, a hand release can be added to replace the foot pedal.

Modular Design

Times-2 Rotary Cabinets are modular. Units can be placed in any floor plan as single Starter units or in combinations of Starter and Add-on units to achieve virtually any configuration. Letter-Size and Legal/A4-Size models are available in ten different heights, from 3-Tier to 8-Tier and Plus-Sizes of 5-, 6-, and 7-Tier which increase slightly in height to accommodate applications outside of the range of a regular unit. The extra space in these models can be used for a Rollout Reference Shelf or to create any configuration that is needed.

Both Letter and Legal Plus-Size models can be ordered as Starter or Add-on Units. Any Add-on unit can be converted to a Starter unit with the purchase and assembly of a simple Conversion Kit.

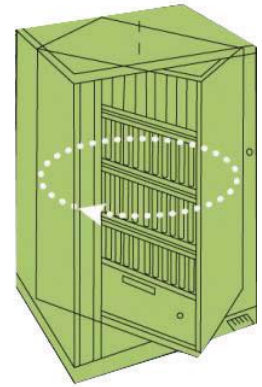

Additionally you can interconnect varying height units from tall-to-short-to-tall for space planning. This unique design function uses wasted space around building controls or under low windows. It can also create a work-station for printers, copiers, etc. The reception area photo shows interconnected Times-2 units that frame a corporate logo and contain coffee supplies and promo items for visitors.

Flexibility

This planning guide features our most popular interior components to provide the ultimate in storage flexibility. Unlike lateral cabinets, Times-2 can store a multitude of different items including binders, books, small electronics, CD/DVDs, boxes, office supplies and filing such as end tab documents, top tab documents, and hanging folders. Reconfigure existing units with new accessories at any time.

The Wardrobe Kit is an accessory that turns a Times-2 into personal storage space for coats, umbrellas, lunches, tablets and running shoes. Configure a new Times-2 or convert an existing unit into an all-in-one personal storage tower.



FEATURES AND BENEFITS

Security

Times-2 Rotary Cabinets have multiple options for security.

- **Standard Lock:** This keyed unit lock protects the entire Times-2 cabinet, keeping documents and personal effects secure.
- **Medeco Security Lock:** Medeco locks, the finest high security lock, can be ordered to provide a heightened level of security.
- **Twin Locks:** Times-2 is the only rotary cabinet that can be outfitted with a dual key security option on the front post. Each lock is keyed differently with the top lock as a supervisor's key.
- **Locking Security Drawer:** Optional locking security drawers ensure that electronics, personal items and confidential documents are secure, but readily accessible. Also used for high risk storage such as pharmaceuticals or confiscated small evidence.
- **Electronic Keypad Lock:** The Electronic Keypad Lock is a battery operated numeric lock with optional Key-Fob that is field installed, replacing the unit key core on Times-2 Cabinets. Separate user codes allow banks of units to be 'keyed differently'. There is built in security with "Failed entry lockout" after 5 incorrect attempts.



Aesthetics and Environmental Benefits

The fit and finish of Times-2 is unsurpassed with tolerances from .015" - .030" so seams meet without gaps and are flush and plumb.

End Panel and Door options such as slat wall, laminate, wood-cladding, or fabric and whiteboard magnetic overlays integrate Times-2 into any setting and space.

Times-2 Cabinets come in 31 beautiful colors in Gloss-Tek powder coat, a finish that has no Volatile Organic Compounds (VOCs). The steel used in Times-2 has 40% recycled content from pre- and post-consumer sources. These green aspects of Times-2 can potentially help with achieving LEED building status.

FEATURES AND BENEFITS

Cost Savings

The best method to compare multimedia storage systems is to use a cost per Linear Filing Inch (LFI). Times-2 LFI costs are demonstrably lower than lateral and vertical files. The flexibility of Times-2 allows for more types of documents to be stored without the expense of converting them into another format.

However, the real economy of Times-2 comes in the monthly office space rental the cabinets can save. This example below replaces lateral files with Times-2 to save 190 sq ft of floor space. The last frame shows current average real estate costs for major cities and the thousands of dollars saved each month by choosing Times-2 over other storage solutions.

Let's consider a fascinating alternative to see how you can save some serious cash, a load of space, and still get all the storage you need.

TAKE THIS EXAMPLE:

Using this 24' x 17' room we've placed 20 lateral cabinets for storage.

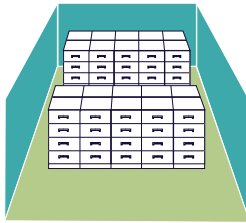

20 Lateral Files 42" wide 4 drawers = 3200 LFI

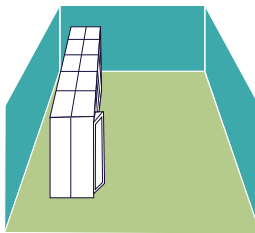

This same space with Times-2 Rotary Cabinets provides more storage and saves space.

10 Rotary Cabinets with 7 Openings = 3360 LFI

You save 190 square feet of space!

What will you do with all that saved space?

Reduce Office Space. Save Real Estate Costs.



	Square Foot Cost*	Monthly Savings
New York	\$74.00	\$14,060
Chicago	\$35.00	\$6,650
San Francisco	\$65.16	\$12,380
Atlanta	\$20.97	\$3,984
Houston	\$28.34	\$5,384

Save serious cash on office space. Pay less for Times-2.



National average rate of monthly office space rental was roughly \$43.79* per square foot per the Skyline report from real estate services firm JLL. *The Square Foot as quoted in Entrepreneur.com 2017.

Safety

Times-2 features Positive Position Control™ a technology in the base that ensures a controlled and positive stop every quarter turn and prevents the 'run-away' momentum that can occur with other competitive free spinning push models.

Pressed-formed raceways eliminate wear and tear on the rotating base assembly. Columnar design support is a base reinforcement that distributes weight safely and evenly whether the unit is unevenly loaded on one side or completely loaded to capacity. The unit will be easy to spin no matter what.

Times-2 floor anchors provide additional safety in geographic regions with seismic concerns.



WARRANTY

Lifetime Limited Warranty: Subject to the conditions stated below Aurora Shelving, Aurora Mobile Systems, Times-2/Times-2 Elite Cabinets and Aurora Museum Cabinets warrant to the original purchaser exclusively that the shelving, carriages, the rotary cabinets and museum cabinets (“structural frames”) manufactured by Aurora Storage Products, Inc., will be free from defects in materials and workmanship other than normal wear and tear for the lifetime of the structural frames. During the warranty period, all parts will be provided at no cost. Labor is included at no cost during the first year of the warranty period. For purposes of this warranty, structural frames shall be deemed to exclude all moving parts, controls and guides that have immediate contact with moving parts.

10-Year Limited Warranty: Aurora also warrants that all carriage drive motors shall be free from defects in materials and workmanship other than normal wear and tear for a period of ten (10) years from the date of the customer’s written acceptance of installation. During the 10-year warranty period, the carriage drive motor will be provided at no cost. Labor is included at no cost during the first year of the 10-year warranty period reimbursed as per the Labor Reimbursement Schedule.

5-Year Limited Warranty: Aurora also warrants that all equipment, other than structural frames and carriage drive motors, shall be free from defects in materials and workmanship other than normal wear and tear for a period of five (5) years from the date of the customer’s written acceptance of installation. During the 5-year warranty period, all covered parts will be provided at no cost. Labor is included at no cost during the first year of the 5-year warranty period reimbursed as per the Labor Reimbursement Schedule.

1-Year Limited Warranty: Aurora also warrants that ceramic heaters contained in the Aurora Drying Cabinet shall be free from defects in materials and workmanship other than normal wear and tear for a period of 1 year

from the date of the customer’s written acceptance of installation. During the 1-year warranty period, all covered parts will be provided at no cost. Labor is included at no cost during the first year of the warranty period reimbursed as per the Labor Reimbursement Schedule. If any warranted product shall be proved to Aurora’s satisfaction to be defective, such product shall be repaired or replaced at the option of Aurora. All warranty service for any product manufactured by Aurora must be performed by an authorized Aurora factory representative. This warranty shall be void if any portion of the purchase price shall be due but unpaid in accordance with the terms pursuant to which the product was sold. This warranty shall not apply to product installed, repaired or moved by any party other than an authorized Aurora factory representative or to defects or damage caused by (a) Acts of God or other circumstances beyond Aurora’s control, (b) improper installation, (c) improper electrical supply or environmental conditions, (d) improper operation, maintenance, or storage, or (e) other than normal use or service. **EXCEPT FOR THE EXPRESS WARRANTIES SET FORTH ABOVE, AURORA MAKES NO WARRANTIES, IMPLIED OR OTHERWISE, AND AURORA SPECIFICALLY DISCLAIMS ANY IMPLIED WARRANTY OF MERCHANTABILITY OR FITNESS FOR A PARTICULAR PURPOSE.**

Limitation of Liability: Repair or replacement of any defective equipment, or refund of the purchase price paid by the customer in the event Aurora determines such equipment cannot be repaired or replaced, shall be the customer’s exclusive remedy for breach of the warranty for product defects, however caused, and in no case shall Aurora be liable for incidental, consequential, special or other damages, or loss of profits or revenues whether as a result of breach of contract of warranty, Aurora’s negligence, or otherwise. Aurora shall have no liability for any advice or assistance by any party outside the scope of Aurora’s written specification for the manufacture, operation or maintenance of the warranted equipment.

STANDARD UNITS AND RN UNITS

Standard Units

Standard Times-2 Rotary Cabinets are designed to store end tab and color-coded folders, books, binders, boxes, and other similar media. Available as either Letter-Size or Legal/A4-Size units, each opening is a minimum of 10" clear. One opening in 4-, 5-, 6-, 7-, and 8-tier units will accept a Rollout Reference Shelf without reducing the 10" clear opening when the above media is stored. The illustration shows (1) 171S Starter Unit and (1) 171A Add-on Unit. Starter Units may be used as stand-alone cabinets. The number of Add-on Units is limited by the available floor space or floor loading considerations which should be verified by a structural engineer.

Standard Units Include

- Sizes: 2-Tier through 8-Tier
- Foot Pedal or Hand Release Function (Add FN to prefix)
- Adjustable, Reversible Shelves
- Shelves vertically adjust on 1³/₄" increments without tools.
- Shelf Dividers
- Key Lock
- Positive Position Control
- Color coordinated, two-ply vinyl door strips for reverse beveled post.
- Times-2 Lifetime Warranty
- 31 Gloss-Tek™ Powder Coat finishes
- Fully compatible accessories that can be ordered immediately or in the future.

RN Units

Times-2 Rotary Cabinets can be ordered as preconfigured units in letter-size or legal-size to meet the demands of today's multimedia storage environments. The RN Unit is one of those configurations. Depending on the model and height specified, up to five full tiers come with Rollout Drawers with Hanging Folder Frames (accessories 1995 Letter/1996 Legal/A4). Above the fifth tier are Adjustable, Reversible Shelves complete with dividers. Shown is (1) 171SRN and (1) 171ARN. Starter Units may be used as stand-alone cabinets. The number of Add-on Units is limited by the available floor space or floor loading considerations which should be verified by a structural engineer.

RN Units Include

- Sizes: 2-Tier through 8-Tier
- Foot Pedal or Hand Release Function (Add FN to prefix)
- All the Features of Standard Units plus:
- Up to five tiers, each side, of Rollout Drawers with Hanging Folder Frames (1995/1996) depending on height and model specified
- Adjustable, Reversible Shelves in 6-, 7-, and 8- Tier Units
- Shelf Dividers



Optional Hand Release



FN UNITS AND EMPTY UNITS

FN Units

FN Units are the economical version of RN Units. The only difference is the design of the Rollout accessory. In FN Units we use the 991 Letter-Size or the 992 Legal/A4-Size Rollout Hanging Folder Frame. The 991/992 frame does not have a bottom so it represents a lower initial cost. Shown is (1) 171SFN and (1) 171AFN Add-on Unit. Starter Units may be used as stand-alone cabinets. The number of Add-on Units is limited by the available floor space or floor loading considerations which should be verified by a structural engineer.



FN Units Include

- Sizes: 2-Tier through 8-Tier
- Foot Pedal or Hand Release Function (Add FN to prefix)
- All the Features of Standard Units plus:
- Up to five tiers, each side, of Rollout Drawers with Hanging Folder Frames (991/992) depending on height and model specified
- Adjustable, Reversible Shelves in 6-, 7-, and 8-Tier Units
- Shelf Dividers

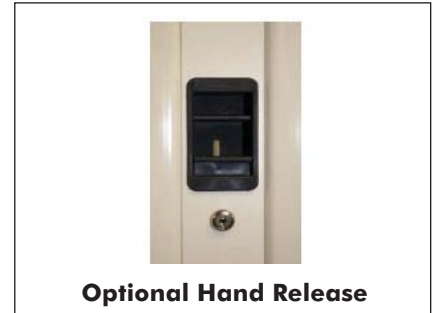

Optional Hand Release

Empty Units

Times-2 Rotary Cabinets can be ordered empty in letter-size or legal-size without Adjustable, Reversible Shelves, Dividers, or Rollout Frames. These units can be specified by adding the suffix "E" to any model number. This "Empty" designation allows for the more experienced space planner or facilities manager to customize the interior for unique storage requirements. Shown is (1) 171SE Starter Unit Empty and (1) 171AE Add-on Unit Empty. Starter Units may be used as stand-alone cabinets. The number of Add-on Units is limited by the available floor space or floor loading considerations which should be verified by a structural engineer.



Empty Units Include

Same rugged construction as Standard Units without shelves or dividers. Custom design the interior to meet your storage requirements!

- Sizes: 2-Tier through 8-Tier
- Foot Pedal or Hand Release Function (Add FN to prefix)
- Positive Position Control
- Key Lock
- Accessories are adjustable on 1 3/4" increments without tools
- Color coordinated, two-ply vinyl door strip for reverse beveled post
- Compatible with all Times-2 Cabinet accessories

Plus-Size Empty Units

Times-2 Plus-Size Letter and Legal/A4-Size Units at the 5-, 6-, and 7-Tier height increase slightly in height to accommodate applications outside of the range of a regular unit.

The extra louver space can be used for a Rollout Reference Shelf or to create any configuration that is needed.

	EXTRA LOUVERS	TOTAL LOUVERS	TOTAL HEIGHT
5-Tier	3	34	66 1/8"
6-Tier	3	40	76 5/8"
7-Tier	4	47	89"

VERTICAL PLANNING INSTRUCTIONS

By knowing how many louvers are necessary to accommodate certain applications, the inside of Times-2 becomes easy to plan. The two following charts show available size openings and the number of louvers in each height unit.

TABLE #1		
Louvers inside the Times-2 are spaced every 1¾". The shelf takes up some of that space, so the "clear" openings as marked below are somewhat smaller. For speed and convenience, a Vertical Planning Sheet is designed to lay out both stock and custom arrangements within your Times-2. The number of louvers and useable space needed for each size opening are:		
Louwer(s)	Useable Space	Application
1 Louver	1¾"	Reference Shelf
2 Louvers	3"	Flat forms (on shelves)
3 Louvers	4¾"	Microfilm/fiche/trays
4 Louvers	6½"	Accessory Drawer for CD/DVD & Small Media
5 Louvers	8¼"	Reduced documents, e.g. Parking Tickets, Voter Registration, Finger Print Cards
6 Louvers	10"	Standard file folder/hanging folders/security drawer/file drawer
7 Louvers	11¾"	3-ring binders/expanded hanging folders
8 Louvers	13½"	Printouts/oblique folder computer printouts
9 Louvers	15¼"	Ledger binders
Rollout Drawers with Hanging Folder Frames: This product usually requires 6 louvers clearance but the top most drawer always requires 7 louvers to clear tabs on top tabbed folders.		

TABLE #2		
Each height Times-2 has a defined number of useable louvers:		
2-Tier (Letter or Legal) 13 louvers		
3-Tier (Letter or Legal) 20 louvers		
4-Tier (Letter or Legal) 25 louvers		
5-Tier (Letter or Legal) 31 louvers		
6-Tier (Letter or Legal) 37 louvers		
7-Tier (Letter or Legal) 43 louvers		
8-Tier (Letter or Legal) 49 louvers		
Times-2 Plus-Sizes (Letter or Legal)	Total Louvers	Total Height
5-Tier Adds 3 Extra Louvers	34	66½"
6-Tier Adds 3 Extra Louvers	40	76⅝"
7-Tier Adds 4 Extra Louvers	47	89"
Once you know both the number of louvers required for a specific size opening and the number of louvers available in the unit you've selected, then the math is simple.		
Using Table #1 and Table #2 above, you can mix and match easily! It all adds up.		
Standard Letter and Legal Preconfigured units:		
<ul style="list-style-type: none"> • Have 6 louvers between each shelf • Have a 10" clearance • Have 10½" centers • Will lose 1 shelf if using top tab folders • Are designed for end tab folders • Will have 11" clearance for top shelf 		

ACCESSORIES

Electronic Keypad Lock Letter or Legal

The Vertical Electronic Keypad Lock replaces the Key Assembly on the Times-2 Lock Post. Available in Black or Chrome color with an optional Key-Fob for remote access, the lock has a 10-Year Lithium Battery. Electronic Lock cannot be used on Times-2 Security Drawers.

KEYPAD LOCK FOOT PEDAL UNITS	KEYPAD LOCK HAND RELEASE UNITS
422C1 Chrome 422B1 Black	421C1 Chrome 421B1 Black
LOCK WITH KEY FOB FOOT PEDAL UNITS	LOCK WITH KEY FOB HAND RELEASE UNITS
422C2 Chrome 422B2 Black	421C2 Chrome 421B2 Black



Adjustable Reversible Shelf

901 Letter-Size, 902 Legal/A4-Size

The Adjustable, Reversible Shelf is supplied with all standard or preconfigured Times-2 Rotary Cabinets. The shelf has a 1/4" lip on one side and is slotted every 1" to accept any of the various sized Times-2 dividers. The shelf is also reversible. When placed with the lip to the back, the shelf can accept color coded or end tab folders. If placed with the lip forward, then items such as office supplies, boxes, or mailroom inserts can be stored with confidence. Order the color of the shelf to match the color of the unit.



Recessed Shelf

901R Letter-Size, 902R Legal/A4-Size

The Recessed Shelf offers specific advantages over the Adjustable, Reversible Shelf in several applications. The Recessed Shelf improves the visibility of items in the lower tiers and typically is used for binder storage. The Recessed Shelf is slotted every 1" to accept all standard Times-2 Dividers. Order the color of the shelf to match the color of the unit.



ACCESSORIES

Reference Shelf

548 Letter-Size, 549 Legal/A4-Size

The Reference Shelf is the most popular Times-2 accessory because it provides the perfect work surface to make storage and retrieval more productive and efficient.

All 4-, 5-, 6-, 7-, and 8-Tier units and Plus-Size 5-, 6-, and 7-Tier units are designed to accept the Reference Shelf without sacrificing any storage capacity when Adjustable, Reversible Shelves are used. When used with Rollout Drawers with Hanging Folder Frames, the Reference Shelf will require 3 louvers (or 4³/₄" in total height). Order the color of the Reference Shelf to match the color of the unit.



Dividers

Times-2 Dividers adjust easily and have sturdy three-point support: two points are on the shelf itself and the third point is under the shelf immediately above. Two dividers per opening in Letter-Size and three dividers per opening for Legal/A4-Size are standard. Divider heights are available to accommodate a variety of openings and media. Order the color of the divider to match the color of the unit.

PART #	DIVIDERS OPENING SIZE
459P	6 ¹ / ₂ "
460P	8 ¹ / ₄ "
461P	10"
462P	11 ³ / ₄ "
463P	13 ¹ / ₂ "
464P	15 ¹ / ₄ "
465P	17"
466P	18"



ACCESSORIES

Magnetic Followers

Magnetic Followers and Mini-Mags are used to compress file folders and other items. Magnetic Followers are typically used inside 480/481 Rollout Drawers to support the file folders. Mini-Mags are used for smaller items. Order the magnetic follower in the color of the unit.

NOTE: Order without magnetic material if Followers are to be used with any magnetically encoded material.

PART #	MAGNETIC FOLLOWER	DIMENSIONS
041	Magnetic Follower	7½" H x 7"W
854	Mini-Mag	4¾" H x 3.97"W
855	Mini-Mag	4¾" H x 4.97"W
856	Mini-Mag	4¾" H x 5.97"W
857	Mini-Mag	4¾" H x 7.3"W



Rollout Drawer with Hanging Folder Frame

1995 Letter-Size, 1996 Legal/A4-Size

The Rollout Drawer with Hanging Folder Frame is the strongest and most flexible Times-2 Accessory. The Rollout Drawer with Hanging Folder Frame will house all popular hanging folders as illustrated. It will also accommodate top tab or end tab folders if the front rail is removed. Our standard 10" opening is all that is required.



Rollout Drawer

480 Letter-Size, 481 Legal/A4-Size

The Rollout Drawer forms the backbone of Times-2 accessories. When used by itself, the Rollout Drawer provides an area of flat storage for material and thereby functions as a work surface or drawer. The drawer has a raised front edge for securely storing bins or trays. All steel construction and suspension slides make it our most durable platform for accessory expansion.

The Rollout Drawer can be converted to take hanging folder frames or modified for top tab or end tab folders. The Rollout Drawer represents real value for changing media because it is cost-effective and easy to change. The drawer is rated for up to 120 lbs of material. Order the Rollout Drawer in the color of the unit.



ACCESSORIES

End Supports

482 Letter-Size, 483 Legal/A4-Size

End Supports are used in the Rollout Drawer to store end tab or top tab folders. These End Supports are inserted into four holes located in each side of the Rollout Drawer. Two supports should be ordered for each drawer, and Magnetic Followers are used to compress the folders.

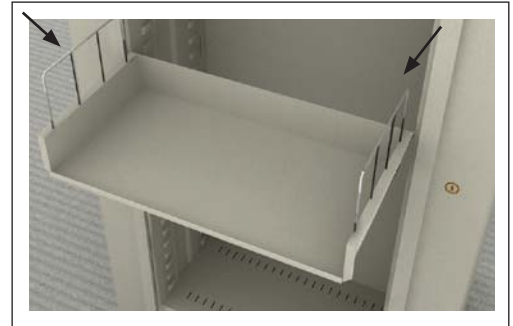

Multipurpose Filing Drawer

880 Letter-Size Drawer/815 Legal/A4-Size Divider

881 Legal-Size Drawer/816 Legal/A4-Size Divider

File top tab or end tab folders in this slotted multipurpose drawer. Dividers are ordered separately and fit into two slots in drawer bottom and one slot in drawer back to keep folders upright. Order the Filing Drawer and Dividers in the color of the unit.



Hanging Folder Rail Set

349P Letter-Size for 880 Drawer

649P Legal/A4-Size for 881 Drawer

Front and Back Rails for Multipurpose Filing Drawer 880 or 881 for hanging files.

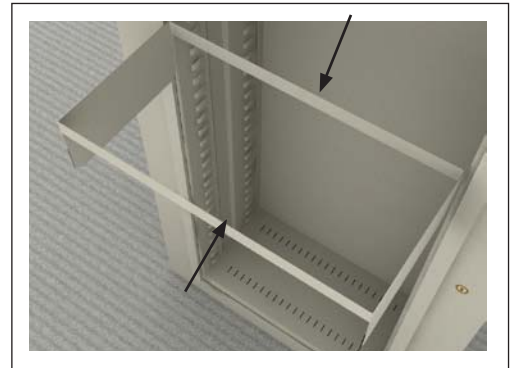

Conversion of Rollout Drawers

The following chart helps specify the parts required for file conversions of Rollout Drawers. For standard folders a 10" opening is all that is required. NOTE: For ease of ordering, many of these applications have their own part numbers.

PART SPECIFICATION	
Applications	Times-2 Accessories
Top Tab Folders	Add End Supports (482 or 483) and Magnetic Followers
End Tab Folders	Add End Supports (482 or 483) and Magnetic Followers
Hanging Folders	Add Hanging Folder Frame (574 or 575)
Small Media	Add Drawer Front (913 or 914)
Small Media	Add Slotted Drawer Back (371 or 372), Drawer Dividers (915 or 916), and Magnetic Followers
Front-to-Back Hanging Folders	Add Converter Bars (152, Legal/A4-Size Only) Folder Frames

ACCESSORIES

Hanging Folder Frame

574 Letter-Size, 575 Legal/A4-Size

For use with 480/481 Rollout Drawer

This frame is used to convert Rollout Drawers to accept hanging folders.

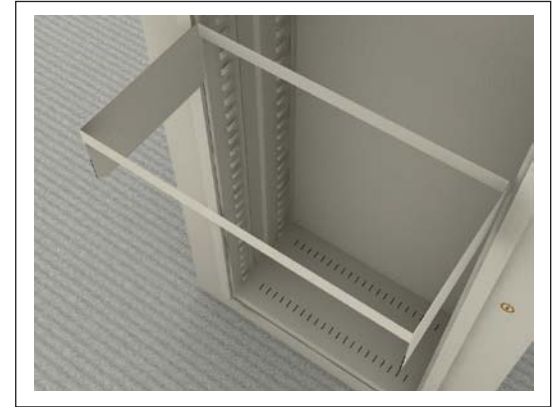

Rollout Hanging Folder Frame

991 Letter-Size, 992 Legal/A4-Size

The Rollout Hanging Folder Frame is the economical alternative to storing hanging folders. The Rollout Hanging Folder Frame requires a standard 10" opening.

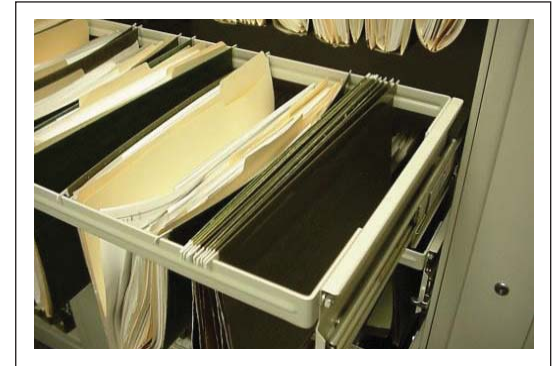

Accessory Drawer

488 Letter-Size, 489 Legal/A4-Size

The Accessory Drawer stores small items such as office supplies, small parts, CD/DVDs, pharmaceuticals, small evidence, and more. Two Drawers will stack into any 10" opening.

The Accessory Drawer comes complete with a drawer front, drawer back, and two front-to-back dividers which adjust every quarter inch. (Legal drawer ships with four dividers.) Additional front-to-back and side-to-side dividers are available.



ACCESSORIES

Converter Bars

152 Legal/A4-Size

Converter Bars are used for Legal/A4-Size units to incorporate Letter-Sized hanging folders. Consisting of three bars that fit into the front and back rails, Converter Bars allow for two rows of front-to-back Letter-Size hanging folders. A standard 10" clear opening is the minimum size required.



Converter Insert

156 Legal/A4-Size only (Uses 481, order separately)

Creates 2 rows of filing for top tab folders. 2 Sections 12½" wide.

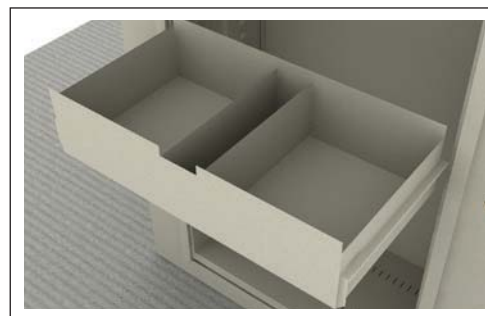

Security Drawer

607 Letter-Size, 608 Legal/A4-Size

For additional privacy in storing valuable items such as tablets, laptops, purses or confidential documents, the Security Drawer can be used in any Times-2 Cabinet. It features a double-bitted lock with key, recessed drawer front, and lock-activated arms that secure the drawer into the door louvers. An Adjustable, Reversible Shelf is required (901/902) above the drawer and is anchored to the door louvers. This shelf is ordered separately. The Security Drawer requires a standard 10" opening.

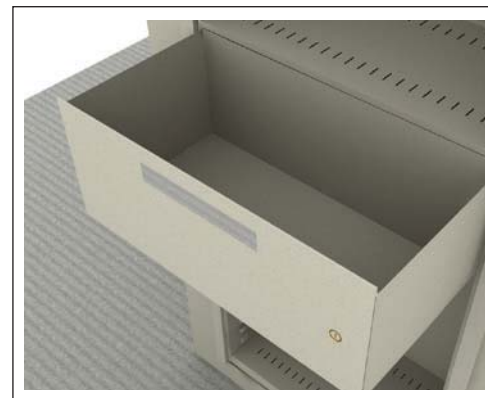

Tub Drawer

374RO Letter-Size, 674RO Legal/A4-Size

The Tub Drawer can be used in any Times-2 for general storage. It can also accept hanging top tab files. Typically an Adjustable Reversible Shelf (901/902) is used above the drawer and is anchored to the door louvers. This shelf is ordered separately. The Tub Drawer requires a standard 10" opening.

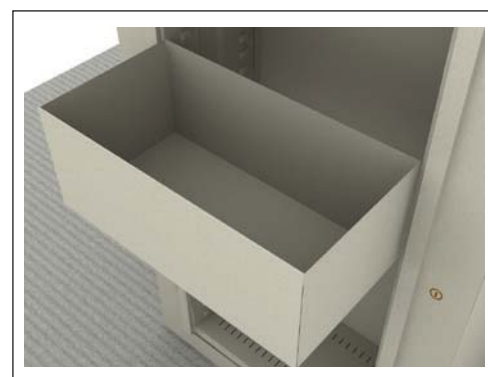

ACCESSORIES

Finger Print Card Drawer Insert

153F Letter-Size/156F Legal/A4-Size

(Requires Letter-Size 480 or Legal/A4-Size 481)

Letter: 2 Sections at 8 $\frac{1}{4}$ " W each

1 Section at 6" W

Legal: 6 Sections at 4 $\frac{3}{4}$ "

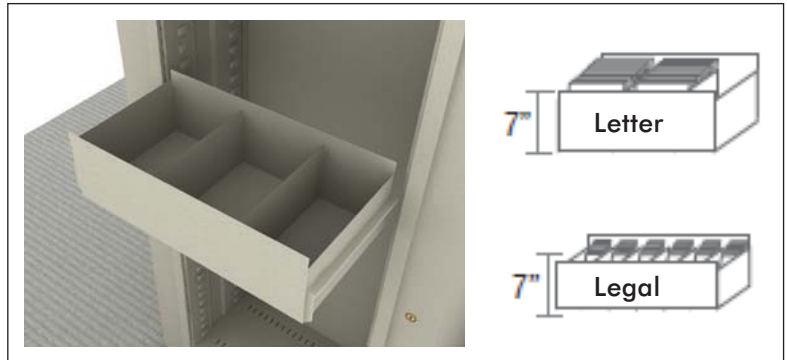

Parking Ticket Drawer Insert

153P Letter-Size/156P Legal/A4-Size

(Requires Letter-Size 480 or Legal/A4-Size 481)

Letter: 4 Sections at 4 $\frac{1}{4}$ " W each

1 Section at 3 $\frac{1}{2}$ " W

Legal: 3 Sections at 8 $\frac{1}{4}$ "

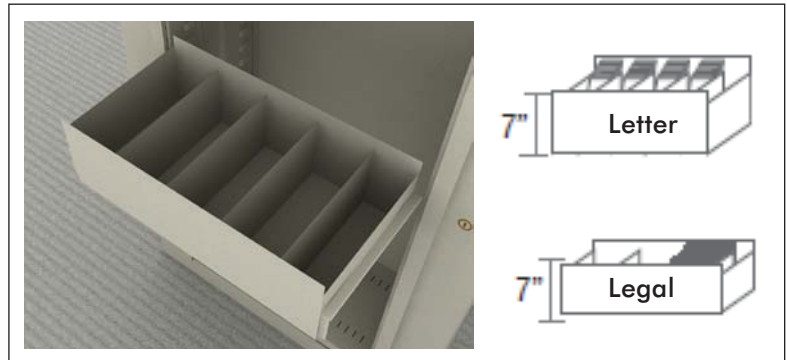

Wardrobe Kit

385WK Letter-Size, 685WK Legal/A4-Size

The Wardrobe Kit turns a Times-2 into a personal storage tower and is used with any new or existing 5-, 6-, 7-, and 8-Tier unit in either Letter or Legal/A4-Size. Store personal items such as coats, lunches, running shoes, or umbrellas, and still have plenty of room for files and work storage.

Kit Includes:

- A vertical panel with louvers on both sides
- Four half-shelves
- One coat hook
- Vertical panel adapter

Wardrobe Kit depicted does not include Security Drawer, Tub Drawer or shelf above Tub Drawer.



ACCESSORIES

Pass Through Center Panel

This accessory provides a convenient large shelf area or pass through, providing a standard 2-tier opening at the top of the unit.

Top 2 levels have no center panel for storage of oversized, long materials. Materials can be accessed from both sides without rotating the cabinet.

Letter-Size Pass Through Center Panels:

116PT 6-Tier

117PT 7-Tier

118PT 8-Tier

Plus-Size:

1163PT 6-Tier

1174PT 7-Tier

Legal/A4-Size Pass Through Center Panels:

256PT 6-Tier

257PT 7-Tier

258PT 8-Tier

Plus-Size:

2563PT 6-Tier

2574PT 7-Tier



Conversion Kits

All Add-on Units can be converted into Starter Units with the addition of a simple Conversion Kit. The Conversion Kit includes all the necessary parts and hardware.

Conversion Kits Include:

- Starter Canopy Top
- (2) Posts with Vinyl Door Strips
- (2) End Panels
- Filler Base

Conversion Kits

Creating Starter Units from Existing Add-On Units

HEIGHT	LETTER-SIZE	LEGAL/A4-SIZE
2-Tier	12CK	22CK
3-Tier	13CK	23CK
4-Tier	141CK	241CK
5-Tier	15CK	25CK
6-Tier	16CK	26CK
7-Tier	17CK	27CK
8-Tier	18CK	28CK

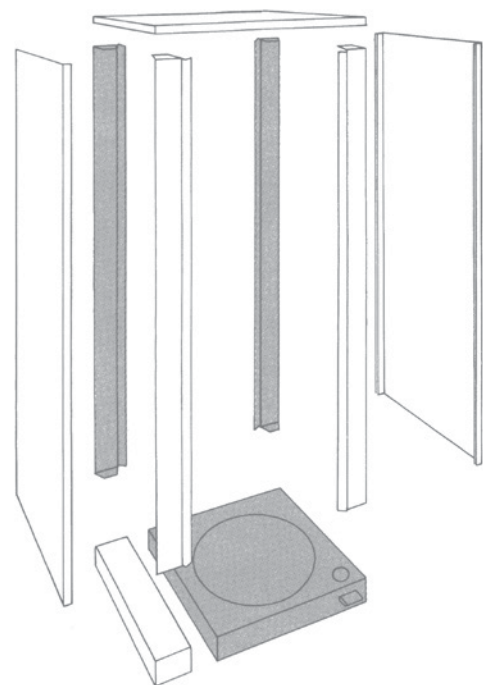

ACCESSORIES

Wall Closing Strips and Extended Canopy Top

These accessories are used to cover the rotational space between the back of Times-2 and a wall, panel, or between Times-2 units in a back-to-back layout. Three styles of Closing Strips are available: Single-Depth Closing Strips, Double-Depth Closing Strips for back-to-back applications, and Closing Strips for use with Extended Canopy Tops. The color of the Closing Strip matches the color of the unit. Extended Canopy Tops cover the rotation space behind any Times-2.

LETTER-SIZE WALL CLOSING		
Size	Single Depth #	Double Depth #
2-Tier	922	942
3-Tier	923	943
4-Tier	9241	9441
5-Tier	925	945
6-Tier	926	946
7-Tier	927	947
8-Tier	928	948

LEGAL/A4-SIZE WALL CLOSING		
Size	Single Depth #	Double Depth #
2-Tier	932	952
3-Tier	933	953
4-Tier	9341	9541
5-Tier	935	955
6-Tier	936	956
7-Tier	937	957
8-Tier	938	958

EXTENDED CANOPY TOPS		
	Letter-Size	Legal/A4-Size
Starter	1096	1086
Add-On	1098	1088

Closing strips for extended canopy tops can be ordered by using the same part numbers in the closing strip charts above. Simply preface the number with a "1".

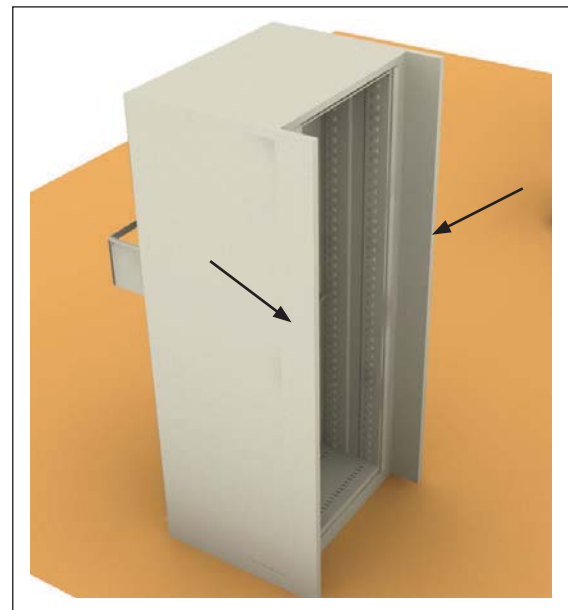

ACCESSORIES

Add Magnetic Overlays to create a dry erase board for meeting notes or to add a fabric design element to the doors of Times-2 units.

Contact Customer Service for available fabric selection.



Magnetic Dry Erase Door Overlays

LETTER-SIZE			
PART #	UNIT SIZE	WIDTH	LENGTH
239DE.X	2-Tier	25"	24 $\frac{1}{4}$ "
339DE.X	3-Tier	25"	36 $\frac{1}{2}$ "
439DE.X	4-Tier	25"	45 $\frac{1}{4}$ "
539DE.X	5-Tier	25"	55 $\frac{3}{4}$ "
639DE.X	6-Tier	25"	66 $\frac{1}{4}$ "
739DE.X	7-Tier	25"	76 $\frac{3}{4}$ "
839DE.X	8-Tier	25"	87 $\frac{1}{4}$ "
PLUS-SIZE			
5393DE.X	5-Tier Plus	25"	60 $\frac{7}{8}$ "
6393DE.X	6-Tier Plus	25"	71 $\frac{3}{8}$ "
7394DE.X	7-Tier Plus	25"	83 $\frac{3}{4}$ "
005DE Board Eraser			
X = G (Greystone), W (White), or S (Sandstone).			

LEGAL/A4-SIZE			
PART #	UNIT SIZE	WIDTH	LENGTH
269DE.X	2-Tier	31"	24 $\frac{1}{4}$ "
369DE.X	3-Tier	31"	36 $\frac{1}{2}$ "
469DE.X	4-Tier	31"	45 $\frac{1}{4}$ "
569DE.X	5-Tier	31"	55 $\frac{3}{4}$ "
669DE.X	6-Tier	31"	66 $\frac{1}{4}$ "
769DE.X	7-Tier	31"	76 $\frac{3}{4}$ "
869DE.X	8-Tier	31"	87 $\frac{1}{4}$ "
PLUS-SIZE			
5693DE.X	5-Tier Plus	31"	60 $\frac{7}{8}$ "
6693DE.X	6-Tier Plus	31"	71 $\frac{3}{8}$ "
7694DE.X	7-Tier Plus	31"	83 $\frac{3}{4}$ "
005DE Board Eraser			
X = G (Greystone), W (White), or S (Sandstone).			

Magnetic Fabric Door Overlays

LETTER-SIZE			
PART #	UNIT SIZE	WIDTH	LENGTH
239FO.X	2-Tier	25"	24 $\frac{1}{4}$ "
339FO.X	3-Tier	25"	36 $\frac{1}{2}$ "
439FO.X	4-Tier	25"	45 $\frac{1}{4}$ "
539FO.X	5-Tier	25"	55 $\frac{3}{4}$ "
639FO.X	6-Tier	25"	66 $\frac{1}{4}$ "
739FO.X	7-Tier	25"	76 $\frac{3}{4}$ "
839FO.X	8-Tier	25"	87 $\frac{1}{4}$ "
PLUS-SIZE			
5393FO.X	5-Tier Plus	25"	60 $\frac{7}{8}$ "
6393FO.X	6-Tier Plus	25"	71 $\frac{3}{8}$ "
7394FO.X	7-Tier Plus	25"	83 $\frac{3}{4}$ "

LEGAL/A4-SIZE			
PART #	UNIT SIZE	WIDTH	LENGTH
269FO.X	2-Tier	31"	24 $\frac{1}{4}$ "
369FO.X	3-Tier	31"	36 $\frac{1}{2}$ "
469FO.X	4-Tier	31"	45 $\frac{1}{4}$ "
569FO.X	5-Tier	31"	55 $\frac{3}{4}$ "
669FO.X	6-Tier	31"	66 $\frac{1}{4}$ "
769FO.X	7-Tier	31"	76 $\frac{3}{4}$ "
869FO.X	8-Tier	31"	87 $\frac{1}{4}$ "
PLUS-SIZE			
5693FO.X	5-Tier Plus	31"	60 $\frac{7}{8}$ "
6393FO.X	6-Tier Plus	31"	71 $\frac{3}{8}$ "
7694FO.X	7-Tier Plus	31"	83 $\frac{3}{4}$ "

ACCESSORIES

Caster Kit

398C Letter-Size/698C Legal/A4-Size

The Times-2 Caster Kit can be added to Times-2 units from 2-Tier through 5-Tier. Kit comes with 2 brackets, 2 locking casters and 2 free spinning casters and hardware.



Quik-Panel Slat Wall

Add a Quik-Panel to any new Times-2 unit or retrofit it in the field. Each panel comes with a hardware kit for mounting. Quik-Panel comes in full height panels to match the ten Times-2 unit heights from 2-Tier to 8-Tier including Plus-Sizes, or order panels in 2', 3' and 4' heights.

Order in standard Wilsonart Laminates or Wood-Tek.

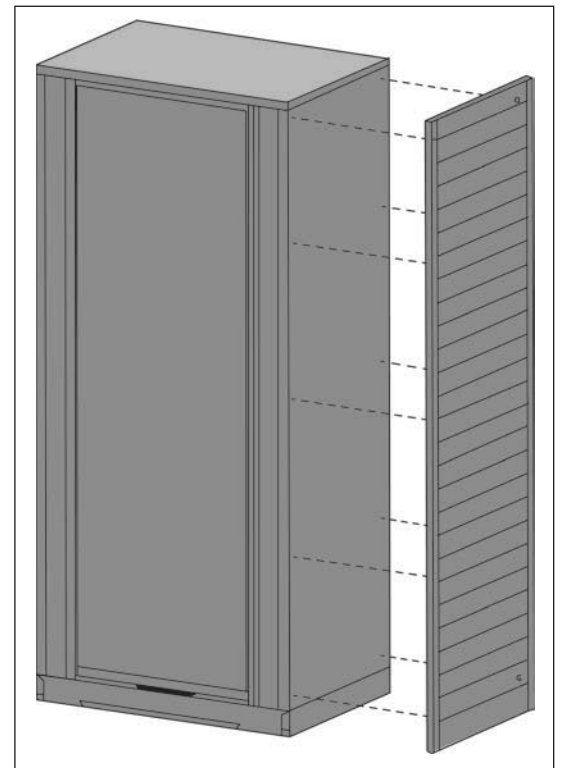

ACCESSORIES

In addition to the accessories listed below, custom designed laminated doors and counter top can be ordered. Contact Customer Service for more information.

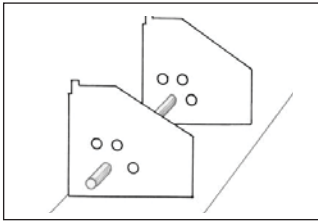

Short Stop Spacer

395 Letter-Size
396 Legal/A4-Size

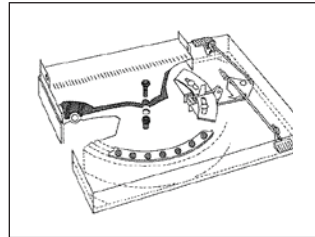

Dual Foot Pedal

538I Letter-Size
025I Legal/A4-Size

Dual Foot Pedal Kit

538K Letter-Size
025K Legal/A4-Size

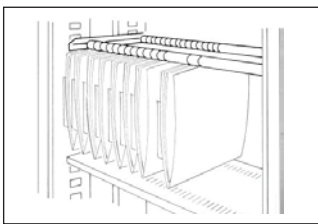

Oblique Rack

613 Letter-Size
614 Legal/A4-Size

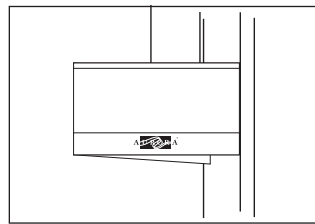

Horizontal Range Finder

839H

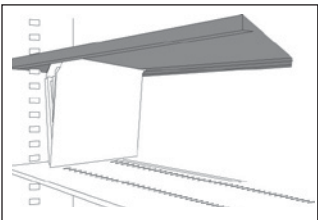

European Fixed Filing Shelf

902E Legal/A4-Size

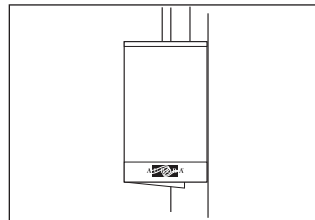

Vertical Range Finder

839V

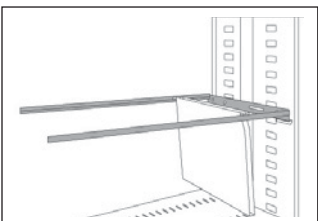

European Fixed Filing Frame

160 Letter-Size
170 Legal/A4-Size

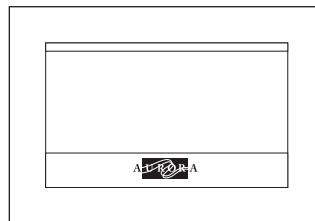

Horizontal Card Holder

LABH599

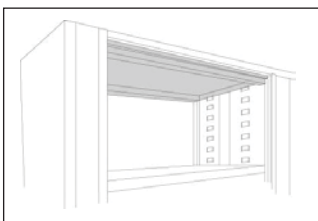

T-Bar Rotor Top

541 Letter-Size
542 Legal/A4-Size

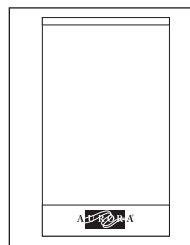

Vertical Card Holder

LABV599

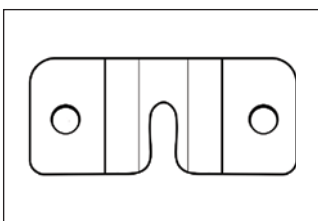

Floor Anchor for Seismic Installations

879

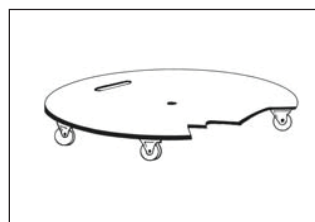

Under Base Dolly

003 Letter-Size
006 Legal/A4-Size

WEAPONS ACCESSORIES

Aurora Weapons Storage Components are designed to mount in Empty Legal/A4-Size Times-2 Cabinets (5-Tier to 8-Tier recommended) to create flexible, space-efficient weapons storage for any rifle, shotgun, machine gun, or handgun. Weapons Storage Components are interchangeable and feature separate stock and barrel holders, sloped stock shelves, hand-gun brackets with and without clip compartments, brackets for mounting rifles and swat weapons horizontally, steel storage boxes, and plastic totes for general storage.

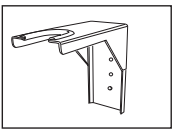

5 1/2" Barrel Saddle

- Holds top of Rifle
- Used with Stock Saddles
- 16 gauge steel with black rubber edging

PART #	D x H x L	CAPACITY
X2WR1RBS5	5 1/2" x 6" x 3"	1
X2WR4RBS5	5 1/2" x 6" x 12"	4
X2WR5RBS5	5 1/2" x 6" x 15"	5
X2WR6RBS5	5 1/2" x 6" x 18"	6
X2WR7RBS5	5 1/2" x 6" x 21"	7
X2WR8RBS5	5 1/2" x 6" x 24"	8
X2WR10RBS5	5 1/2" x 6" x 30"	10

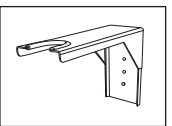

7" Barrel Saddle

- Holds top of Rifle
- Used with Stock Saddles
- 16 gauge steel with black rubber edging

PART #	D x H x L	CAPACITY
X2WR1RBS7	7" x 6" x 3"	1
X2WR4RBS7	7" x 6" x 12"	4
X2WR5RBS7	7" x 6" x 15"	5
X2WR6RBS7	7" x 6" x 18"	6
X2WR7RBS7	7" x 6" x 21"	7
X2WR8RBS7	7" x 6" x 24"	8
X2WR10RBS7	7" x 6" x 30"	10

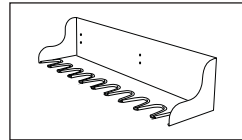

Stock Saddle

- Holds bottom of Rifle
- Used with Barrel Saddles
- 16 gauge steel with black rubber edging

PART #	D x H x L	CAPACITY
X2WR1RBS5	7" x 6" x 3"	1
X2WR4RBS5	7" x 6" x 12"	4
X2WR5RBS5	7" x 6" x 15"	5
X2WR6RBS5	7" x 6" x 18"	6
X2WR7RBS5	7" x 6" x 21"	7
X2WR8RBS5	7" x 6" x 24"	8
X2WR10RBS5	7" x 6" x 30"	10

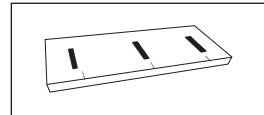

Sloped Bottom Shelf

- Used to hold Rifle Stocks

PART #	W x H x D
X2WRBS	30" x 2" x 14"

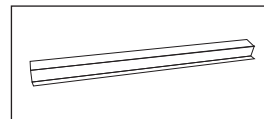

Sloped Bottom Shelf Stop

- Stop for front of Sloped Bottom Shelf
- 18 gauge steel

PART #	W x H x D
X2WRBSS	30" x 2" x 2"

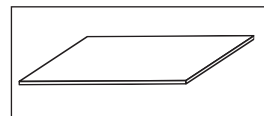

Rubber Mat for Sloped Bottom Shelf

- Used to hold Rifle Stocks

PART #	W x H x D
WRMAT	48" x 1/8" x 24"

WEAPONS STORAGE

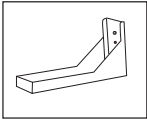

Sloped Stock Shelf

- Holds bottom of all types of large weapons
- 16 gauge steel

PART #	D x H x L	CAPACITY
X2WR1RSSHF	11" x 6" x 3"	1
X2WR4RSSHF	11" x 6" x 12"	4
X2WR5RSSHF	11" x 6" x 15"	5
X2WR6RSSHF	11" x 6" x 18"	6
X2WR7RSSHF	11" x 6" x 21"	7
X2WR8RSSHF	11" x 6" x 24"	8
X2WR1ORSSHF	11" x 6" x 30"	10

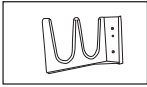

Horizontal Bracket

- Holds weapon horizontally
- Two brackets per set
- 16 gauge steel, with black rubber edging
- Two (2) or three (3) weapon capacities

PART #	D	CAPACITY
X2WR2RHB	9½"	2
X2WR3RHB	13½"	3

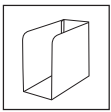

Steel Storage Box

- Ammunition and general storage
- 16 gauge steel

PART #	W x H x D
X2WRSB3	3" x 7½" x 6"
X2WRSB6	6" x 7½" x 6"

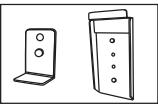

Plastic Tote Accessory

- Brackets and Clips, 16 gauge steel
- Formed to accept plastic totes (from others)
- Totes mounted on brackets with integrated clips
- Clip secures tote to unit

PART #	DESCRIPTION
X2WRTB	Tote Bracket
X2WRTC	Tote Clip

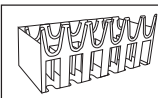

Hand Gun Bracket with Clip Component

- Bracket back, 11 gauge steel
- Gun saddle, 16 gauge steel, black rubber edging

PART #	D x H x L	CAPACITY
X2WR1PWC	7¼" x 6¾" x 3"	1
X2WR5PWC	7¼" x 6¾" x 12"	5
X2WR6PWC	7¼" x 6¾" x 15"	6
X2WR7PWC	7¼" x 6¾" x 17½"	7
X2WR8PWC	7¼" x 6¾" x 28"	8
X2WR9PWC	7¼" x 6¾" x 22½"	9
X2WR11PWC	7¼" x 6¾" x 27½"	11

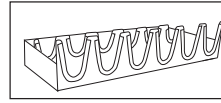

Hand Gun Bracket without Clip Component

- Bracket back, 11 gauge steel
- Gun saddle, 16 gauge steel, black rubber edging

PART #	D x H x L	CAPACITY
X2WR1P	7¼" x 4¼" x 3"	1
X2WR5P	7¼" x 4¼" x 12"	5
X2WR6P	7¼" x 4¼" x 15"	6
X2WR7P	7¼" x 4¼" x 17½"	7
X2WR8P	7¼" x 4¼" x 20"	8
X2WR9P	7¼" x 4¼" x 22½"	9
X2WR11P	7¼" x 4¼" x 27½"	11

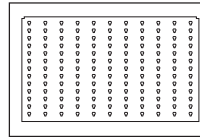

Weapons Unit Back Panel

- Keyhole slots accept brackets and accessories
- 16 gauge steel

PART #	W x H
X2WRBP10.50	30" X 10½"
X2WRBP21.00	30" X 21"
X2WRBP31.50	30" X 31½"

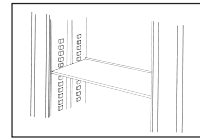

Weapons Rack Shelf

PART #	W x H x D
902WR	30" x 1" x 14"

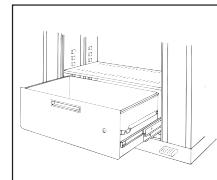

Rollout Drawer and Accessory

608 Security Drawer

Shelf above Security Drawer is an additional option. Not designed for hanging file folders.

(28½" W x 10¼" H x 15" D)

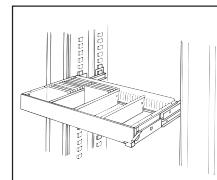

489 Rollout Accessory Drawer

4 Dividers Included.

(28½" W x 3¼" H x 15" D)

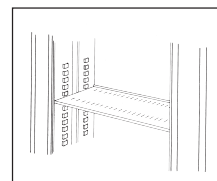

902 Adjustable, Reversible Shelf

(30" W x 15¼" D)
110 lbs. Capacity per shelf.

WEAPONS STORAGE

Weapons Storage Back Panel Layout

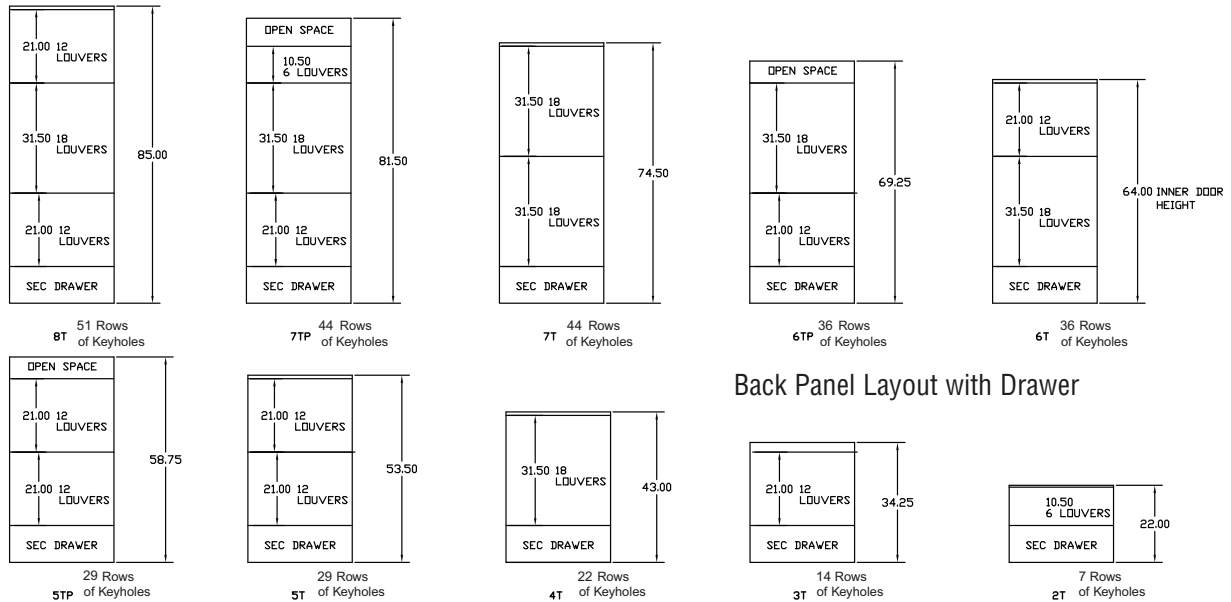

Back Panel Layout with Drawer

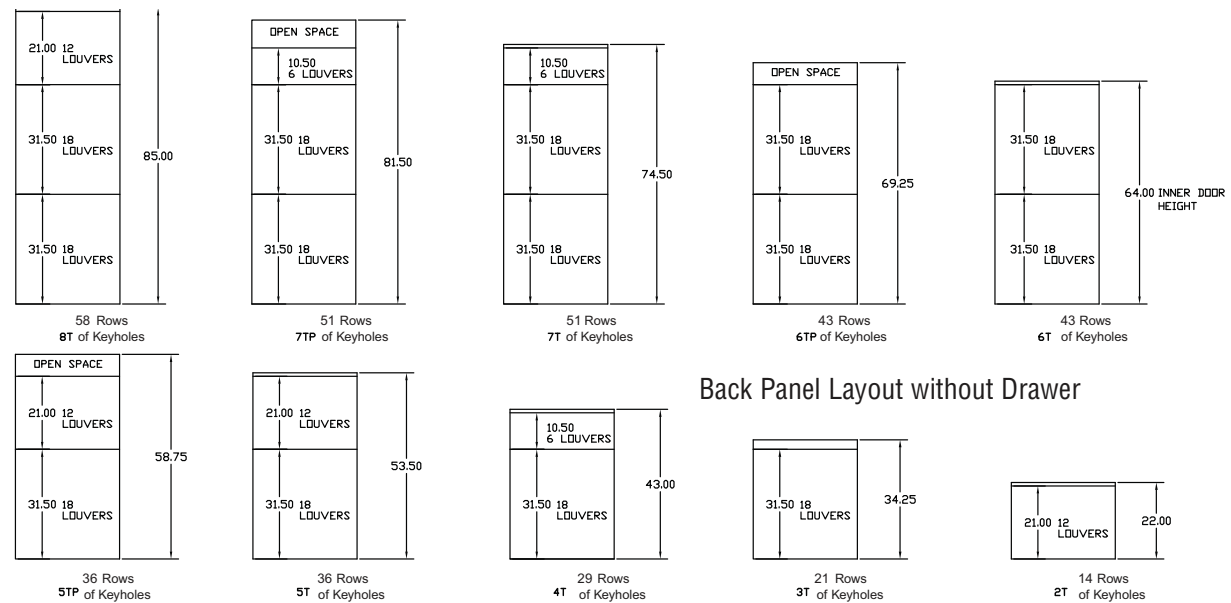

Back Panel Layout without Drawer

Horizontal Rifle Capacity

Back Panel Number of Keyhole Columns: 10 Columns
 Rifle Capacity: 10
 Bracket Required: 2 or 1
 Capacity of Bracket: 5 or 10

Horizontal Handgun Capacity

Back Panel Number of Keyhole Columns: 10 Columns
 Handgun Capacity: 11
 Bracket Required: 2 or 1
 Capacity of Bracket: 5 + 6 or 11

Vertical Clearance Requirements

Accessory	Height	Vertical Keyholes Used
Barrel Holder Bracket	6"	5
Sloped Shelf	2"	3
Optional Shelf Stop	2"	3
Handgun Bracket	4"***	5
Handgun Bracket with Clip Component	6"***	6

***It is recommended that 2" of clearance be allowed at the top of the handgun bracket for adequate room to store and remove weapons.

STRUCTURAL WEIGHT ISSUES

Capacity, workflow, square footage and equipment selection are four important elements for space planning. The fifth element leading to a successful design is confirmation of your building's weight load. To ensure your project is a success, please confirm that the building floor is capable of supporting a fully loaded system that consists of the estimated Aurora system and media weight. We can help by providing your team with equipment and media weight estimates. We can also help with providing alternate equipment configurations and floor load reinforcement solutions if needed. Please note that the estimated weight for letter and legal filing are based on an average of the ranges published by BIFMA* (Business and Institutional Furniture Manufacturers Association). Both filing estimates from BIFMA and other media estimates provide here by Aurora can vary based on the specific type of materials stored. We provide these estimates only as a guide. *Vertical Files - Tests ANSI/BIFMA X5.3-1997

Media	FLOOR LOADING WEIGHTS PER FILING INCH		
	Weight Per Filing Inch	Form Size –H–	Form Size –D–
Letter-Size	2.27 lbs.	9 1/2"	11 29/32"
Legal/A4-Size	2.80 lbs.	9 1/2"	15 1/32"
Books	1.30-2.40 lbs.	Various	Various
5"x3" Index Cards	.45 lbs.	4 1/2"	5 1/32"
6"x4" Index Cards	.72 lbs.	4 1/2"	5 1/32"
6"x2 3/4" Check	.80 lbs.	2 3/4"	6"
4 1/2"x8 3/4" Check	.55 lbs.	4 1/2"	8 3/4"
Tab Cards	.71 lbs.	4 1/2"	7 13/32"
6"x4" Microfiche	1.08 lbs.	4 1/2"	6 1/6"
Securities	5.11 lbs.	12"	18 1/8"
Binders	2.75 lbs.	12"	5 7/16"
CDs	2.67 lbs.	5 5/8"	5"
Slip Case DVDs	2.00 lbs.	5 3/8"	7 1/2"
Periodicals	2.50-3.00 lbs.	Various	Various

Unit Height/Model	LETTER-SIZE		
	Unit	Material	Total
121S Starter, 96 LFI	174 lbs.	222 lbs.	396 lbs.
121A Add-on, 96 LFI	140 lbs.	222 lbs.	362 lbs.
131S Starter, 144 LFI	234 lbs.	334 lbs.	568 lbs.
131A Add-on, 144 LFI	190.25 lbs.	334 lbs.	524.25 lbs.
141S Starter, 192 LFI	267.25 lbs.	445 lbs.	712.25 lbs.
141A Add-on, 192 LFI	215 lbs.	445 lbs.	660 lbs.
151S Starter, 240 LFI	300.75 lbs.	557 lbs.	857.75 lbs.
151A Add-on, 240 LFI	238.25 lbs.	557 lbs.	795.25 lbs.
161S Starter, 288 LFI	339 lbs.	668 lbs.	1007 lbs.
161A Add-on, 288 LFI	266.5 lbs.	668 lbs.	934.5 lbs.
171S Starter, 336 LFI	377.5 lbs.	780 lbs.	1157.5 lbs.
171A Add-on, 336 LFI	294.5 lbs.	780 lbs.	1074.5 lbs.
181S Starter, 384 LFI	416 lbs.	891 lbs.	1307 lbs.
181A Add-on, 384 LFI	322.5 lbs.	891 lbs.	1213.5 lbs.

Unit Height/Model	LEGAL/A4-SIZE		
	Unit	Material	Total
221S Starter, 120 LFI	240 lbs.	278 lbs.	518 lbs.
221A Add-on, 120 LFI	193 lbs.	278 lbs.	471 lbs.
231S Starter, 180 LFI	315.5 lbs.	531 lbs.	846.5 lbs.
231A Add-on, 180 LFI	257.75 lbs.	531 lbs.	788.75 lbs.
241S Starter, 240 LFI	363.5 lbs.	708 lbs.	1071.5 lbs.
241A Add-on, 240 LFI	295.75 lbs.	708 lbs.	1003.75 lbs.
251S Starter, 300 LFI	412.75 lbs.	885 lbs.	1297.75 lbs.
251A Add-on, 300 LFI	332.75 lbs.	885 lbs.	1217.75 lbs.
261S Starter, 360 LFI	462 lbs.	1062 lbs.	1524 lbs.
261A Add-on, 360 LFI	369.75 lbs.	1062 lbs.	1431.75 lbs.
271S Starter, 420 LFI	511 lbs.	1239 lbs.	1750 lbs.
271A Add-on, 420 LFI	406.5 lbs.	1239 lbs.	1645.5 lbs.
281S Starter, 480 LFI	560.25 lbs.	1416 lbs.	1976.25 lbs.
281A Add-on, 480 LFI	443.5 lbs.	1416 lbs.	1859.5 lbs.

SPACE PLANNING

Next-To-Wall or Panel

Times-2, positioned next to permanent walls, demountable walls, or open-plan panel systems, increases both capacity and access to stored media. Capacity over traditional lateral files will increase from a minimum of 40% to a maximum of 200% growth. Faster access times are standard with Times-2. Half of all media stored is immediately available to the employee. The other half is just a spin away.

To allow for full rotation of Times-2, turning space must be designed into each floor plan. This space can be concealed with the addition of a wall closing strip at the back. Rotation space along the top can be concealed with the addition of an extended canopy top.

Rotation Space

Letter: $5\frac{7}{8}$ "

Legal: $7\frac{1}{4}$ "

Back-To-Back

Times-2, when used in a back-to-back configuration, delivers the maximum possible storage capacity in the allowable floor space.

Times-2 eliminates an entire aisle without compromising access. Half of the stored material is still available for immediate retrieval, and the other half remains a turn away.

The rotation space between back-to-back units may be planned as either single or double-depth. Appropriately sized wall closing strips are available for each option. Extended canopy options conceal the rotation space at the top of the unit. In shorter heights, custom laminate or wood tops are also an attractive option.

Rotation Space

Letter: $11\frac{3}{4}$ "

Legal: $14\frac{1}{2}$ "



SPACE PLANNING

Room Divider

In addition to storage capacity gains, Times-2 delivers cost reduction and productivity benefits.

When used as a room divider, Times-2 delineates each space, eliminates the cost of construction or furniture panels, and still provides increased access to all stored materials. Specify the dual foot pedal option in this application. The double-depth design of Times-2 means that both sides of the unit are accessible simultaneously when used as a room divider. When closed, the units are secured on both sides.



Through-the-Wall or Panel

Imagine having access to media in another room without leaving the room you occupy. Times-2 is the storage system to specify when two rooms or offices must share information or items.

Times-2 Rotary Cabinets, when installed through a wall or furniture system, can do just that. With a gentle push, the rotating interior turns and delivers the contents of the other side.

A suggested application is for two rooms, one used as a meeting room and the other a service room. Training material, supplies and even lunches and beverages can be loaded into the service room without disturbing the participants. In this application, the Times-2 is flush to the wall on one side and projects into the room on the other side. A dual pedal option must be specified when dual access is required.



SPACE PLANNING

Built-In Alcove

Floor plans are made more productive when high-capacity Times-2 units are built into an alcove. The alcove can be constructed of traditional drywall materials, or in open office space plans, the alcove can be created with modular partitions. This application allows the architect or engineer the freedom to position Times-2 directly over structural beams or between columns and still allows the designer to integrate high density and fast retrieval storage into demanding environments. With custom finishes or decorative laminate door options, Times-2 can match any surrounding décor.

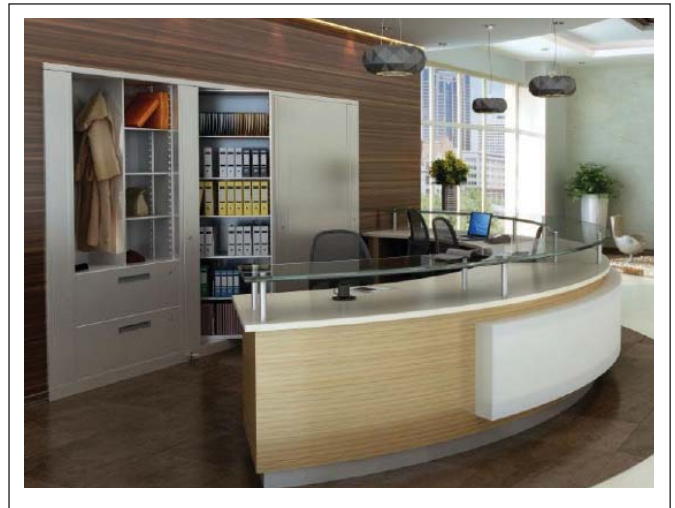

Collaboration Table

Laminated counter tops, mounted to 2- or 3- Tier Times-2 Rotary Cabinets, provide essential work surfaces for a variety of sorting, collating, and paper flow purposes. Times-2 offers laminated work tops (particle board core) for single and multiple unit configurations.

Aurora Storage Design Support will also supply all needed dimensions for your custom millwork for executive solid wood requirements, wood veneered, or artificial surface work tops. Specify if wood top should cover rotation space or be finished on all four sides.



Rotation Space

Letter: $57\frac{7}{8}$ "

Legal: 74"



SPACE PLANNING

Interconnect

Often the space under low windows, oddly shaped spaces, or under building controls cannot be easily used for storage. Times-2 Interconnect is the solution for these wasted spaces. With Times-2 you can combine varying height units from tall-to-short-to-tall to use this remnant space.



Closed-Back Units

Times-2 Rotary Cabinets can be specified with closed backs for security purposes when single-sided access is required. Closed backs can be covered by fabric panels to integrate the units into any office décor. Existing units can be retrofitted with closed backs as well. Closed backs are priced as an option to Starter and Add-on units. Closed backs are available in all heights and sizes including Plus-Size units.

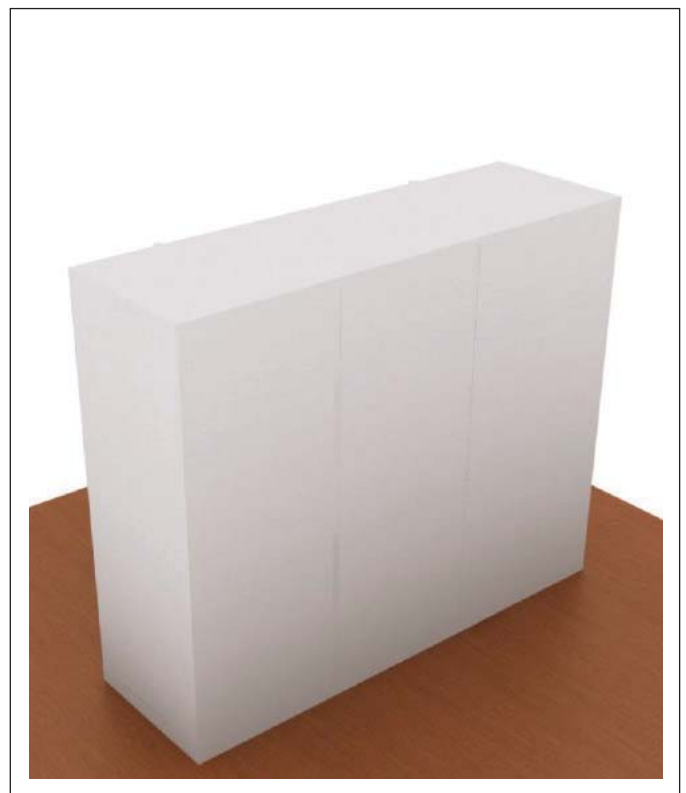

SPACE PLANNING

Shared Benching Workstations

Times-2 is also used for shared benching workstations to provide personal storage for each employee. The Wardrobe Tower affords a convenient place for personal items along with work materials. Stow coats and backpacks on the wardrobe side, and books, binders or files on the half-shelves. Add a locking security drawer (shown) for valuables or material that should be secured.



TIMES-2 VERTICAL PLANNING WORKSHEET

TABLE #1

Louvers inside the Times-2 Rotary Cabinets are spaced every 1.75". The shelf takes up some of the space, so the "clear" openings as marked below are somewhat smaller. The number of louvers and useable space needed for each size opening are:

Louver	Useable Space	Application
1 Louver =	1.75"	Reference Shelf
2 Louvers =	3"	Flat forms
3 Louvers =	4.75"	Microfilm/fiche/trays
4 Louvers =	6.5"	Accessory Drawer for CD/DVD & Small Media
5 Louvers =	8.25"	Reduced documents, e.g. Parking Tickets, Voter Registration, Fingerprint Cards
6 Louvers =	10"	Standard file folder/hanging folders/security drawer
7 Louvers =	11.75"	3-ring binders/tape seals/ expanded hanging folders
8 Louvers =	13.5"	Printouts/oblique folders/ computer printouts
9 Louvers =	15.25"	Ledger binders
10 Louvers =	17"	Jumbo sized documents

Rollout Drawers with Hanging Folder Frames:

This product usually requires 6 louvers clearance but the top most drawer always requires 7 louvers to clear tabs on top tabbed folders.

TABLE #2

Each height Times-2 has a defined number of useable louvers:

- 2-Tier (letter or legal) 13 louvers
- 3-Tier (letter or legal) 20 louvers
- 4-Tier (letter or legal) 25 louvers
- 5-Tier (letter or legal) 31 louvers
- 6-Tier (letter or legal) 37 louvers
- 7-Tier (letter or legal) 43 louvers
- 8-Tier (letter or legal) 49 louvers

Times-2 Plus-Sizes (Letter or Legal)

- 5-Tier Adds 3 Extra Louvers
- 6-Tier Adds 3 Extra Louvers
- 7-Tier Adds 4 Extra Louvers

Total Louvers	Total Height
34	66.125"
40	76.625"
47	89"

