

WOVEN WIRE PARTITIONS

STYLE

840



it's what you make of them!

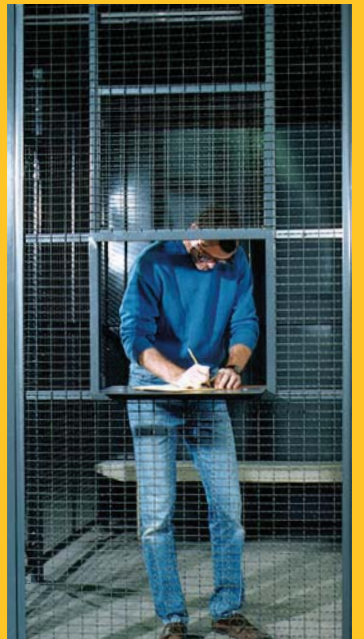

# Style 840

The amazingly versatile woven wire partition.

SOUTHWEST SOLUTIONS GROUP  
business organization systems



## System Benefits

### The Proven Style of Today's Wire Partition

For over 35 years, Wire Crafters has manufactured what we feel is the "Very Best Woven Wire Partition." Contrary to traditional systems, our Style 840 is based on the simple idea that panels stack one on top of the other between tubular posts to reach the finished partition height. This all-welded, modular, stackable system has benefits unequaled in the industry.

### The Style 840 Solution

- **MODULAR DESIGN**  
Twenty basic panels and our "building block" approach accomplish virtually any layout.
- **FAST INSTALLATION**  
Fewer parts than standard partition systems. Angle frames give clear access to all mounting hardware.
- **STRONG**  
Panels bolt directly to support posts. Standard 3/8" wedge anchors hold partition firmly in place. Base plates welded on posts allow direct floor anchoring.
- **CLEAN DESIGN**  
Straight lines and clean exterior makes a handsome finishing touch.
- **FLEXIBLE**  
Easy to reconfigure as needs change.
- **SECURE**  
Utilizes the heaviest assembly hardware in the industry. Bolts are only accessible from inside.

**Stock items are available for shipment within 48 HOURS OF YOUR ORDER.**

Style 840 System Benefits	1
Panels & Posts	2
Hinged Doors	3
Doors & Windows	4
Ceilings and Door Openers	5
Standard Locks	6
Custom Locks	7
Pallet Rack Back	8
Pallet Rack Enclosures	9
Physical Barriers	10
Alternative Materials	11
Also Available:	
MezzaRail Mezzanine Railing	12
Storage Lockers	12
DEA Storage Cages	12
Guard Rails	12
Estimating Worksheet	13
Style 840 Specs	14
Color Chart	14

## Index

# Panels & Posts

Simple, economical, modular design

## Panels

### MODULAR PANELS

- Ten widths, 1' to 10' in one foot increments.
- Two heights: 4'-0" and 5'-0"
- Full height partition walls are built by stacking two or more panels between posts.
- Mesh: 10 gauge wire woven into 2" x 1" rectangular openings.
- Frame 1-1/4" x 1-1/4" x 1/8" steel angle.
- Custom size panels available.
- Alternate meshes available, see page 11.

### ADJUSTABLE PANEL

- Solid sheet metal panel.
- Fill small gaps in runs.
- Allows for adjustment from 1" to 11".
- Ideal for hard to measure areas.
- Two heights: 4' and 5' match panel heights.

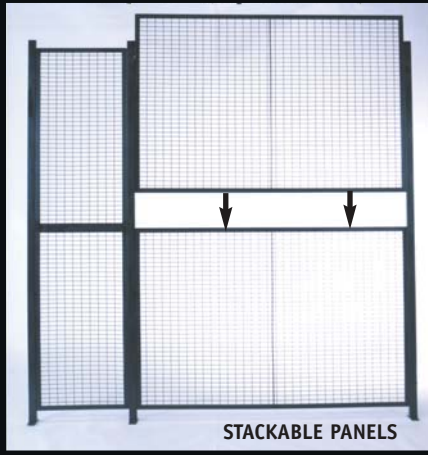

### WOVEN WIRE PANELS 4 Ft. High

Part No.	Width x Height	Weight
104	10'-0" x 4'-0"	63
94	9'-0" x 4'-0"	58
84	8'-0" x 4'-0"	53
74	7'-0" x 4'-0"	46
64	6'-0" x 4'-0"	41
54	5'-0" x 4'-0"	36
44	4'-0" x 4'-0"	31
34	3'-0" x 4'-0"	23
24	2'-0" x 4'-0"	18
14	1'-0" x 4'-0"	13

### WOVEN WIRE PANELS 5 Ft. High

Part No.	Width x Height	Weight
105	10'-0" x 5'-0"	74
95	9'-0" x 5'-0"	68
85	8'-0" x 5'-0"	63
75	7'-0" x 5'-0"	54
65	6'-0" x 5'-0"	48
55	5'-0" x 5'-0"	42
45	4'-0" x 5'-0"	36
35	3'-0" x 5'-0"	27
25	2'-0" x 5'-0"	22
15	1'-0" x 5'-0"	16

### ADJUSTABLE PANEL

Part No.	Width x Height	Weight
AP4	1' 3-7/8" x 4' 0"	13
AP5	1' 3-7/8" x 5' 0"	16

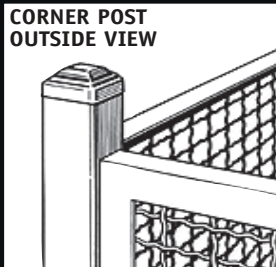
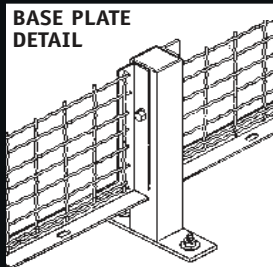

## Posts

### POSTS

- Stock sizes: 8'-5 1/4", 10'-5 1/4", 12'-5 1/4".
- Standard hole layout allows for 3-1/4" sweep-space.
- Posts project 2" above top of panel.
- Standard Baseplate: 2" x 7" with holes for anchors.
- Special length posts are available to 40'.
- Oversized baseplates are available.
- Floor anchors (3/8") are included with your order.

### STOCK SIZE POST

Part No.	Height	Weight
<b>RP-8</b>		
Run	8'-5-1/4"	20
<b>CP-8/TP-8</b>		
Corner/Tee	8'-5-1/4"	21
<b>RP-10</b>		
Run	10'-5-1/4"	23
<b>CP-10/TP-10</b>		
Corner/Tee	10'-5-1/4"	24
<b>RP-12</b>		
Run	12'-5-1/4"	33
<b>CP-12/TP-12</b>		
Corner/Tee	12'-5-1/4"	33

# Hinged Doors

Secured Access to Your Storage Areas

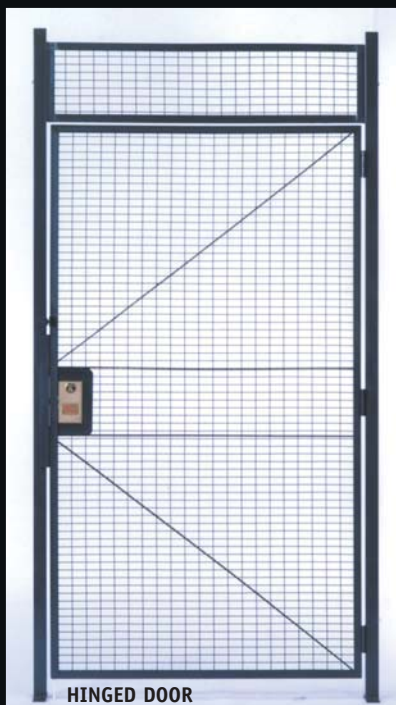

**HINGED DOOR**

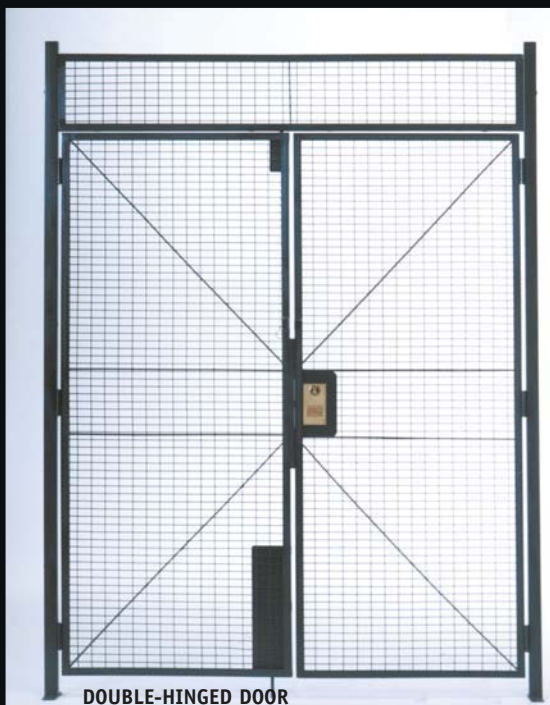

**DOUBLE-HINGED DOOR**

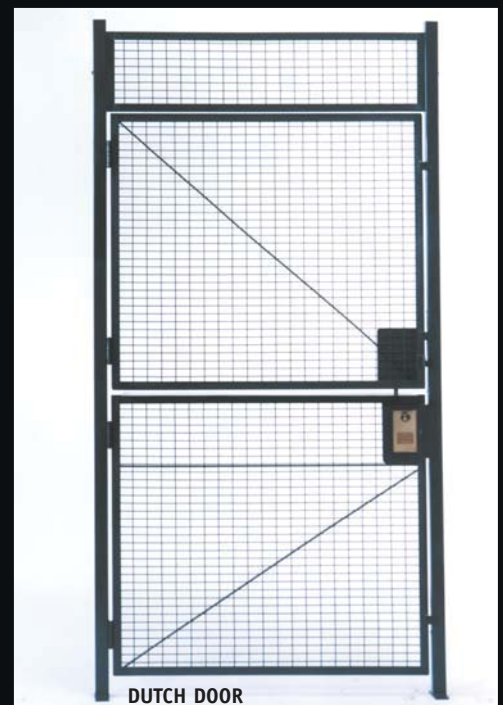

**DUTCH DOOR**

## HINGED DOORS

- 3' or 4' wide by 7' 3-1/4" high opening.
- Transom panel sized to match partition height.
- Three 4" x 4" 10 gauge tight pin hinges.
- Padlock lugs standard, cylinder locks available.
- Complete with two door posts and hardware.
- Universal construction, works for left or right hand, inside or outside swing.

## DOUBLE-HINGED DOORS

- 6' or 8' wide by 7' 3-1/4" high opening.
- Inactive leaf secured by cane bolt (base) and chain bolt (top).
- Padlock lugs standard, cylinder locks available.
- Complete with two door posts and all hardware.
- Transom panel sized to match partition height.
- Custom size and no over head obstruction doors available.

## DUTCH DOORS

Same as Hinged Door except:

- Two separate operating door leaves.
- Bottom leaf locks with padlock, cylinder lock available.
- Top leaf locks to bottom with spring bolt.
- 10 gauge shelf, 18" deep x door width fixed to bottom leaf.
- Must specify hand and swing of door.



## STYLE 840 WOVEN WIRE DOORS

### HINGED DOORS

Part No.	Opening Width x Height	Weight
HD-37-8	3'-0" x 7'-3 1/4"	106
HD-47-8	4'-0" x 7'-3 1/4"	118
HD-37-10	3'-0" x 7'-3 1/4"	123
HD-47-10	4'-0" x 7'-3 1/4"	139

### DOUBLE-HINGED DOORS

Part No.	Opening Width x Height	Weight
DHD67-8	6'-0" x 7'-3 1/4"	170
DHD87-8	8'-0" x 7'-3 1/4"	193
DHD67-10	6'-0" x 7'-3 1/4"	190
DHD87-10	8'-0" x 7'-3 1/4"	217

### DUTCH DOORS

Part No.	Opening Width x Height	Weight
DD37-8/Swing Out	3'-0" x 7'-3 1/4"	125
DD47-8/Swing Out	4'-0" x 7'-3 1/4"	142
DD37-10/Swing Out	3'-0" x 7'-3 1/4"	145
DD47-10/Swing Out	4'-0" x 7'-3 1/4"	166

# Doors & Windows

A Wide-Range of Products to Fit Your Needs



SLIDING DOOR

## SLIDING DOORS

- 3', 4', 5', 6', 8' or 10' widths.
- Full height partition openings of 8' and 10'.
- Padlock lug standard, cylinder lock available.
- Complete with two door posts, two 4 wheel trolley trucks, 16 gauge track, and all hardware.
- Universal construction, works for left/right hand, inside/outside.
- Custom sizes available.

**Inset Photo:** *Our patented tamper-resistant sliding gate receiver.*  
U.S. Patent # 6196034B1



## STYLE 840 WOVEN WIRE DOORS SLIDING DOORS

Part No.	Width x Height	Weight
SD-38-8	3'-0" x 8'-1/4"	124
SD-48-8	4'-0" x 8'-1/4"	137
SD-58-8	5'-0" x 8'-1/4"	149
SD-68-8	6'-0" x 8'-1/4"	196
SD-88-8	8'-0" x 8'-1/4"	230
SD-108-8	10'-0" x 8'-1/4"	279
SD-310-10	3'-0" x 10'-1/4"	149
SD-410-10	4'-0" x 10'-1/4"	168
SD-510-10	5'-0" x 10'-1/4"	185
SD-610-10	6'-0" x 10'-1/4"	234
SD-810-10	8'-0" x 10'-1/4"	277
SD-1010-10	10'-0" x 10'-1/4"	334



TUNNEL DOOR

## TUNNEL DOORS

- Designed for no overhead obstruction.
- Leading edge of door rolls on floor casters.
- Rear of door hangs from door track.
- All sizes made to order.
- Ideal for high traffic areas, and overhead crane access.

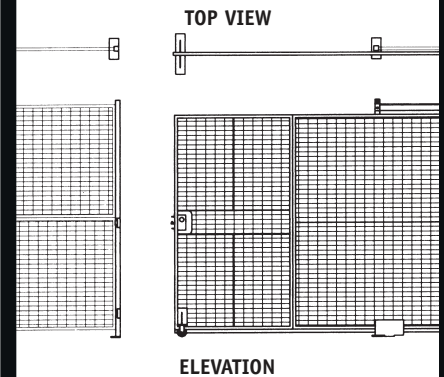

ELEVATION



SERVICE WINDOW

## SERVICE WINDOWS

- Lockable, slide-up window secures opening when unattended.
- Window opening: 24" wide x 20-1/2" high.
- Shelf size: 24" wide x 18" deep x 10 gauge.
- Shelf height: 42-1/4" off of floor level.
- Panel size: 4'-0" wide x 8'-0" high; transoms extend height to 10' or 12'.
- Counter balanced, hinged, or mechanically operated windows in various sizes are available.

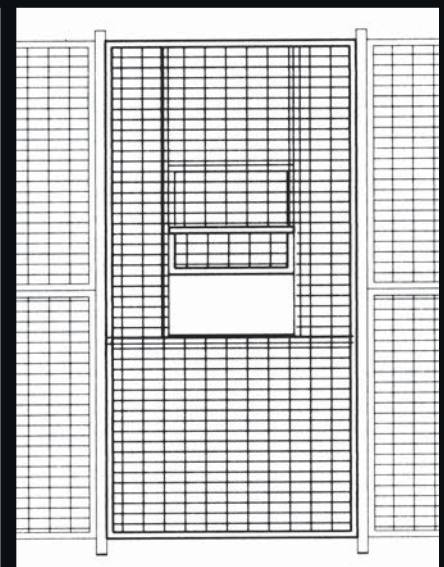

# Ceilings & Openers

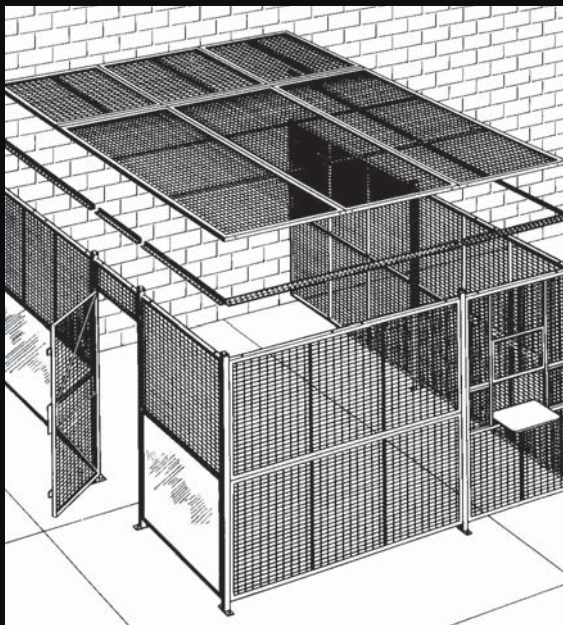

## CLEAR-SPAN CEILINGS

- Ceiling panels interchangeable with wall panels.
- Attach to partition walls with slotted angle.
- Clear spanned up to 35'.
- Large ceilings supported by horizontal ceiling tubes.
- Add to existing partition without changing layout.
- All ceilings are non-load bearing.
- Ceiling cutouts or drop down doors available.

## VERTICAL RISE GATES

- Sized to customer requirements.
- Gate slides up and out of the way.
- Counter balanced, pneumatic, and electric operators available.
- Often used with vertical lifts.
- Can be integrated with automated storage/retrieval systems.

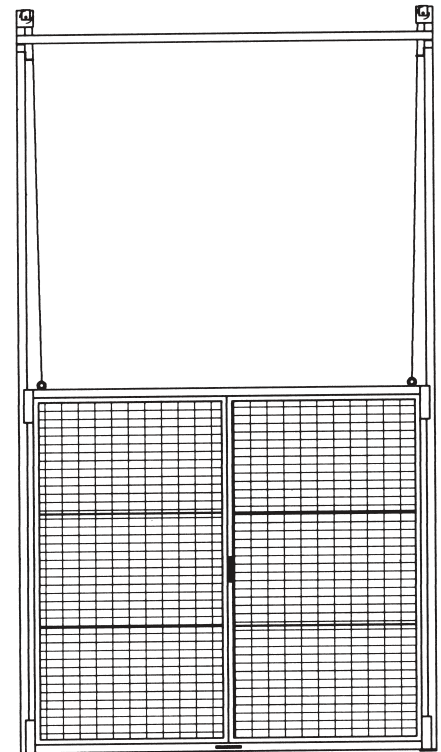

## DOOR OPENERS AND SELF-CLOSING GATES

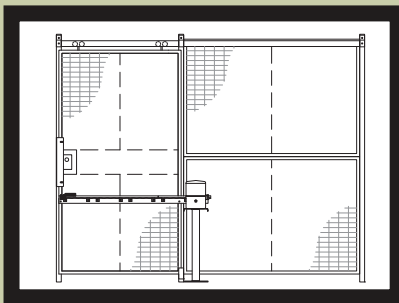

**ELECTRIC DOOR OPENER** Uses standard 110 volt single phase electric motor with rack and pinion drive. Supplied with radio frequency remote controls, self closing timer, anti-crush safety switch, and photo eye safety switch, stationary push button control, electro-magnetic locks optional.

**PNEUMATIC DOOR OPENER**  
Requires facility supplied compressed air of 40psi. Cylinders operated by stationary palm button, lever valve, or electric solenoid. Works with vertical rise or slide to side gates.



**HINGE DOOR CLOSER** Commercial grade hydraulic door closer causes door to close and latch upon release.



### SELF CLOSING SLIDING GATES

Requires no external power source. Counter balanced weight and pulley system closes and locks gate upon release.

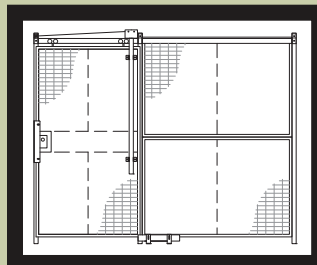

Integrated Vertical Rise Gate and Conveyor System

# Standard Locks

Standard Fronts and Backs Ship Within 48-Hours.

STANDARD FRONT (SF-1)



ALTERNATE FRONTS

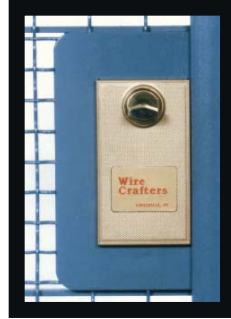

(SF-2) Thumb-Turn Latch... latches only, does not lock.



(SF-3) Door Knob Entry... latches only, does not lock.

**ALTERNATE FRONTS** work with any of the three backs shown below.

**ALTERNATE BACKS** work with any of the locks shown to the left.

STANDARD BACK (SB-1)



ALTERNATE BACKS



(SB-2) Interior Key... lock from both sides, keyed to match face side.



(SB-3) Door Knob... typical size door knob for easy exit.



(SB-4) Lever Handle... alternative to standard door knob. Meets ADA requirements.

## keying options

### STANDARD CYLINDERS:

- Standard locks are supplied keyed different.
- Keyed alike locks available
- Optional Master Key available

### ALTERNATE CYLINDERS:

- Best Cylinder® Less Core
- Any 1" mortise cylinder



**Put our lock "Know-How" to the test!**

Let us know if you need a special locking device. We have experience with many different lock styles. Let us put our experience to work for you. Call toll-free today for more information, or contact the WireCrafters dealer nearest you. Call 800-626-1816!

# Custom Locks

Makes a Great Product...Even Greater.

## ELECTRICAL LOCKING DEVICES



**(CE-1) Coded Card Reader** ...activates electric strike or magnetic lock upon insertion of coded card. Ten cards supplied. Requires key pad controller for card activation. Card readers available on hinged and sliding gates.



**(CE-2) Ten-Digit Key Pad**...operates electric strike or magnetic lock upon entry of four-digit pass code. Programmable up to 64 different codes. Numeric key pads available on hinged and sliding gates.



**(CE-3) Electro-Magnetic Lock** ...magnetically locks sliding gates securely closed. Requires card code reader, ten-digit key pad or remote push button to operate. **Available for sliding gates only.**



**(CE-4) Electric Strike**...allows hinged gates to open when activated by encoded card, ten-digit key pad, or remote push button. Works with standard key locks. **Available on hinged gates only.**

## LEVER HANDLES



**(CF-1) Master Lock® ADA Handle**...meets ADA requirements, available with or without key lock. (Key Lock shown)



**(CB-1) Master Lock® ADA Handle** ...meets ADA requirements, available with or without key. (Twist button lock shown)

## CODED ENTRY

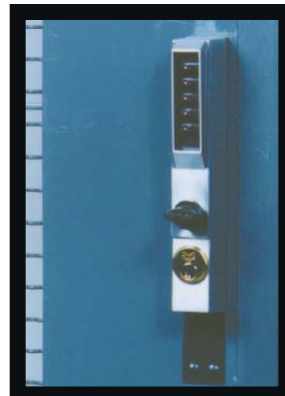

**(CF-2) Five-Button Coded Access Lock** ...code or key entry. Match with push paddle or thumb turn knob inside.

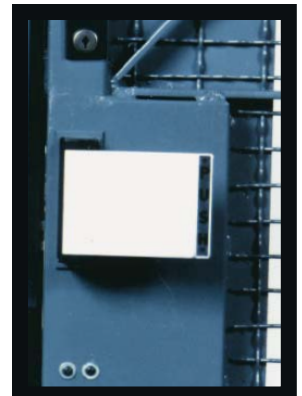

**(CB-2) Push Paddle**...hand-sized paddle for quick exit. Match with key or five-digit push button lock.

## OTHER BACK OPTIONS

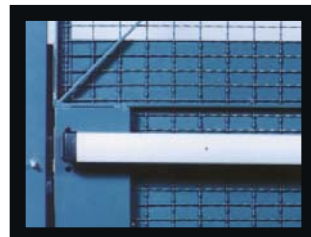

**(CB-3) Push Bar**...push bar runs full width of door. Match with key or five-digit push button lock.



**(CB-4) Alarm Lock**...sounds battery powered alarm when opened. Available with or without exterior key access.



# Rack Back™

## Pallet Rack Backing



### “BACK ANY RACK” WITH WIRECRAFTERS MODULAR PANEL SYSTEM.

Sturdy framed panels provide hassle-free installation by bolting directly to rack uprights with our right angle mounting brackets. Panels may be extended above the rack with our “above-the-top” extension supports.

- Mounting brackets bolt directly to rack uprights, panels bolt to brackets.
- Off-set brackets allow for load to overhang rack beams.
- Creates sturdy barrier between stocked items and the ground below.
- System installs quickly, with standard nuts and bolts.
- Panels may be extended above the last beam to contain top loads.
- Backing may be started at floor, or at any level where protection is required.
- Prevents spills into walkways and other personnel areas.

### POPULAR RACK BACK PANEL SIZES

Panels stocked in 1' wide increments. Custom sizes available – Call for details. Four brackets per panel are required for installation.

#### FOUR FOOT PANELS

Part No.	Width x Height	Weight
124	12'-0" x 4'-0"	77
104	10'-0" x 4'-0"	63
94	9'-0" x 4'-0"	58
84	8'-0" x 4'-0"	53

#### FIVE FOOT PANELS

Part No.	Width x Height	Weight
125	12'-0" x 5'-0"	90
105	10'-0" x 5'-0"	74
95	9'-0" x 5'-0"	68
85	8'-0" x 5'-0"	63

### RACK BACK™ is easy to order

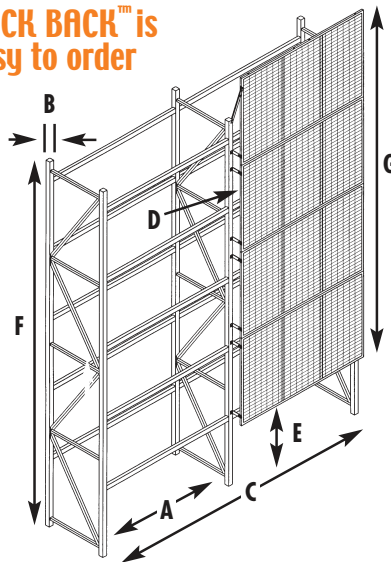

Fax or call with the following information and we'll fax back a quote and layout drawing in no time – most always on the same day.

- A Beam width between rack uprights
- B Upright width
- C Overall number of bays
- D Required offset dimension from upright to panel (to allow for pallet overhang)
- E Mounting height above floor (if not flush-to-floor)
- F Overall height of rack uprights
- G Desired backing height



### OFF-SET MOUNT BRACKETS

Panels mount to the pallet rack upright with an offset bracket. Mounting brackets from flush mount to 12" off-set available. Four brackets are required per panel.

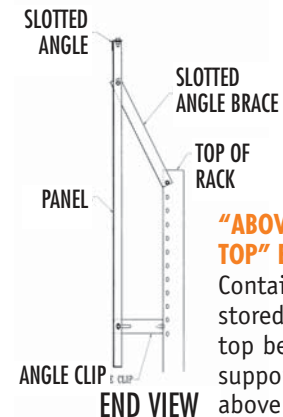

### “ABOVE THE TOP” EXTENSION

Contain loads stored on the top beam. Angle supports extend above the rack, anchoring the RACK BACK™ panel securely in place.

# Rack Enclosures

## Pallet Rack Back™ Enclosures



### COMPLETELY ENCLOSE YOUR PALLET RACK SYSTEM AND SECURE INVENTORY!

It's so simple to add extra security to your pallet rack system with WireCrafters hinged and sliding gates. Control access and prevent inventory theft with our pallet rack enclosures.

### CUSTOM DESIGNED GATES.

Due to the wide-array of sizes available, our in-stock sliding and hinged gates work for nearly every pallet rack application. When your project calls for a special size, we offer custom design and manufacturing.

### RACK ENCLOSURES SECURE INVENTORY

A Rack Back enclosure will control access to, and help prevent theft of, your high valued inventory items. A complete enclosure consists of panels on the back, ends, and top of the rack, with access gates on the front. Different configurations may be installed according to your specific needs.



## Gates

### PALLET RACK SLIDING GATES

- Ideally suited for multi-bay application.
- Our unique "double track" system keeps doors out of your way, and aisles clear of obstruction.
- Full height doors available up to 20-feet tall.
- Locking options available for added security.

### PALLET RACK DOUBLE-HINGED GATES

- Ideally suited for single bay applications.
- Mount directly to the rack uprights.
- Full height doors available up to 20-feet tall.
- Locking options available for added security.

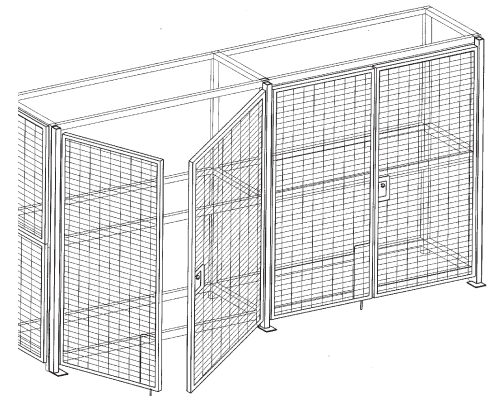
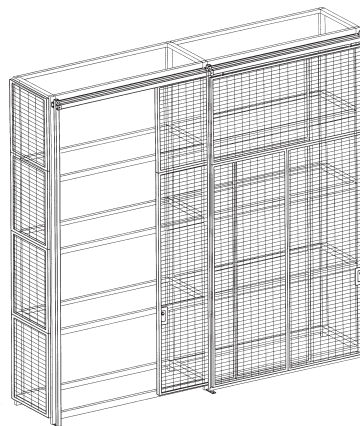

# Physical Barriers

Adds Safety to the Workplace

## STANDARD 5' HIGH PANELS

Part No.	Width	Weight
105	10'	74
95	9'	69
85	8'	63
75	7'	54
65	6'	48
55	5'	42
45	4'	36
35	3'	27
25	2'	22
15	1'	16

The sizes listed are stock items. Custom sizes available.

## POSTS

Part No.	Height	Sweep Space
RP6	6'-2"	1'-0"
CP6	6'-2"	1'-0"

## GATES

Part No.	Opening Width	Type
HD3	3'-0" x 5'-0"	Hinged
HD4	4'-0" x 5'-0"	Hinged

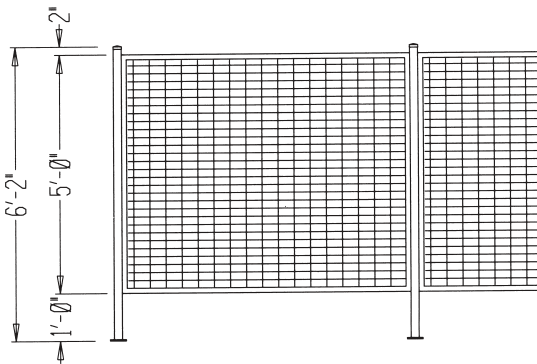

TYPICAL ELEVATION

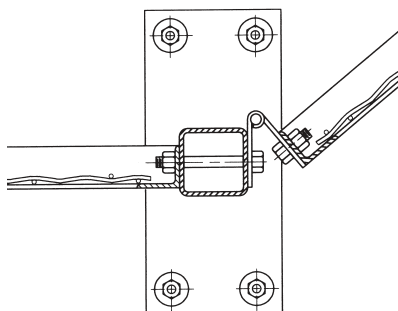

TOP VIEW OF ADJUSTABLE MOUNTING

# Physical Barriers



PHYSICAL BARRIER



BARRIER WITH WELD CURTAINS



DIAMOND STYLE BARRIER

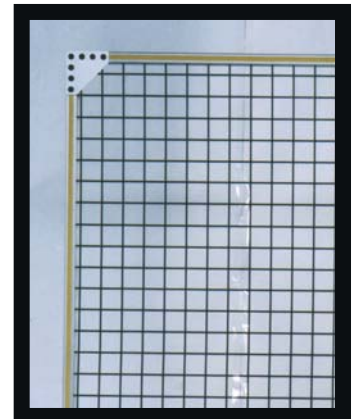

ALUMINUM EXTRUDED FRAMES

## PHYSICAL BARRIERS

Woven wire panels provide a simple but effective way to protect personnel from the dangers of automated equipment. The versatility our Style 840 System allows us to meet many different customer demands while using standard product. Various heights, sweep spaces, lift out sections, non-right angle corners, heavy mesh, lexan panels, sheet metal panels, are all easily accomplished with our basic design. Some examples of our barriers are pictured above. Call us with your requirements.

## OPTIONS

- Weld curtains
- Diamond Style Barrier
- Aluminum Extruded Frame Barriers

## COLORS

The Physical Barrier may be ordered in any color. Our standard color is gray. The combinations of yellow, or yellow and black shown are options.

# Alternate Materials

## Choose from Special Meshes, Sheet Metal and Lexan

Other materials can be used when our standard 2" x 1" opening mesh does not meet your needs. WireCrafters stocks several different sized meshes, sheet metal, lexan, expanded metal and welded wire for these special applications. Several of

the more popular items are pictured below. Our large inventory and modern manufacturing techniques allow us to make fast delivery of custom product, giving you an edge on the competition.

WireCrafters can upgrade the panel frames to larger angle, and increase the tubing size of the posts to meet your exact requirements. We are experienced with these special projects and welcome them.

# special mesh

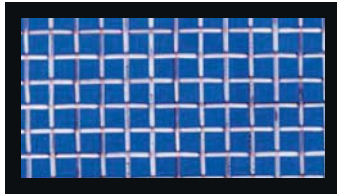

1/2" center-to-center square  
12 gauge (3/8" square opening)

Uses: Any application which requires control over small items.

- Machine guards
- Small liquor bottles
- Federal Reserve
- Drug control

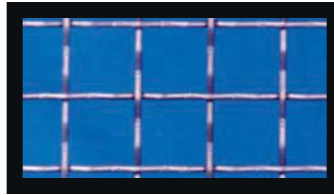

1-5/8" center-to-center square  
8 gauge (1-1/2" square opening)

Uses: Galvanized partitions  
This heavy mesh eliminates warping which may occur during the hot dip galvanize process.

Also used when our standard 2" x 1" 10 gauge is not strong enough.

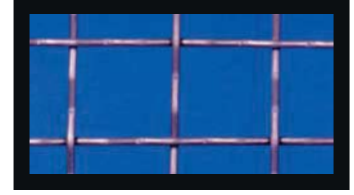

2-1/4" center-to-center square  
6 gauge (2" square opening)

Uses: Heavy duty construction

- Government facility import areas
- Police holding cells
- Prison lockup areas



2" center-to-center square  
8 gauge welded wire mesh  
(1-7/8" square opening)

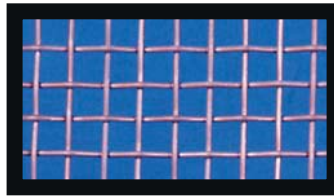

3/4" center-to-center square  
10 gauge (5/8" square opening)



1-1/2" diamond mesh  
10 gauge

## sheet metal, lexan® and expanded metal



16-GAUGE SHEET METAL



EXPANDED METAL

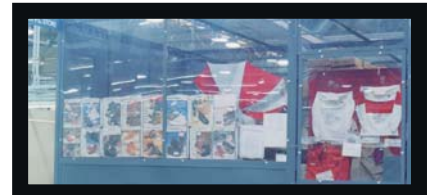

LEXAN® CLEAR VIEW PANELS

# Also available

## Unique Woven Wire Applications

# Storage Lockers/Guard Rails



### MEZZARAIL®

WireCrafters combined the strength of square handrail with the versatility of woven wire partition to create a unique handrail for mezzanines. MezzaRail, designed to replace multiple rail systems, outperforms them too. With its built-in kick plate and top rail,

MezzaRail sets up quicker – just two bolts per section – and acts as a barrier. Objects that pass through a multi-rail system are restrained by MezzaRail. Meets BOCA and OSHA codes for handrails. *For more information request our Protective Railing brochure.*



### DEA APPROVED ENCLOSURES

When properly installed, WireCrafters Style 840 Partitions meet or exceed the requirements for storage of Class III, IV and V controlled substances as outlined in Section 1301:72 of the Code. For these applications the enclosure must be totally secure, gaps

between the partition and building structure may not exist. Doors must be self-closing and self-locking; all hardware must be brazed, pinned or tack welded in place. *For more information visit [www.wirecrafters.com](http://www.wirecrafters.com)*

### OPEN MESH LOCKERS



### SHEET METAL LOCKERS



### STORAGE LOCKERS

WireCrafters' Woven Wire Storage Lockers are ideal for small enclosures. The units may be used individually or as a group. Two styles of lockers, single and double-tiered, are available in a variety of widths

and depths. Doors are prehung in angle frames which connect directly to wall panels. Two-sided units fit in the corner of existing rooms. Free standing units may be installed anywhere. *For more information ask for our Locker Brochure.*



### GUARD RAILS

When Safety and Protection Matter...

- Constructed from heavy-duty 11-gauge formed steel.
- Mounting columns are available in two styles – single rail (17" height) or double rail (43" height).
- Lift-out rails allow easy access to protected areas.

- Base plates, for mounting to floor, are 10" square and come with four 7/8" holes for floor anchors (included).
- Rails are available in 2', 4', 6', 8', and 10' lengths.
- Competitively priced.
- *For more information request our Protective Railing brochure.*

# SSG Wire Partition Worksheet

	<b>Height:</b> <input type="checkbox"/> Standard 8' 5-1/4" <input type="checkbox"/> Standard 10' 5-1/4" <input type="checkbox"/> Standard 12' 5-1/4" <input type="checkbox"/> Other _____ (please specify)
Name	
Company	
Address	<b>Color:</b> <input type="checkbox"/> Standard Gray <input type="checkbox"/> Other _____ (please specify)
City/State/Zip	
Fax #	<b>Ceiling:</b> <input type="checkbox"/> Yes <input type="checkbox"/> No
Phone #	
Zip Code of Ship-To Destination	<b>Locks:</b> <input type="checkbox"/> Padlock Lugs Only <input type="checkbox"/> Cylinder Lock Keyed <input type="checkbox"/> Alike <input type="checkbox"/> Different <input type="checkbox"/> Special Lock Device _____ (please specify)

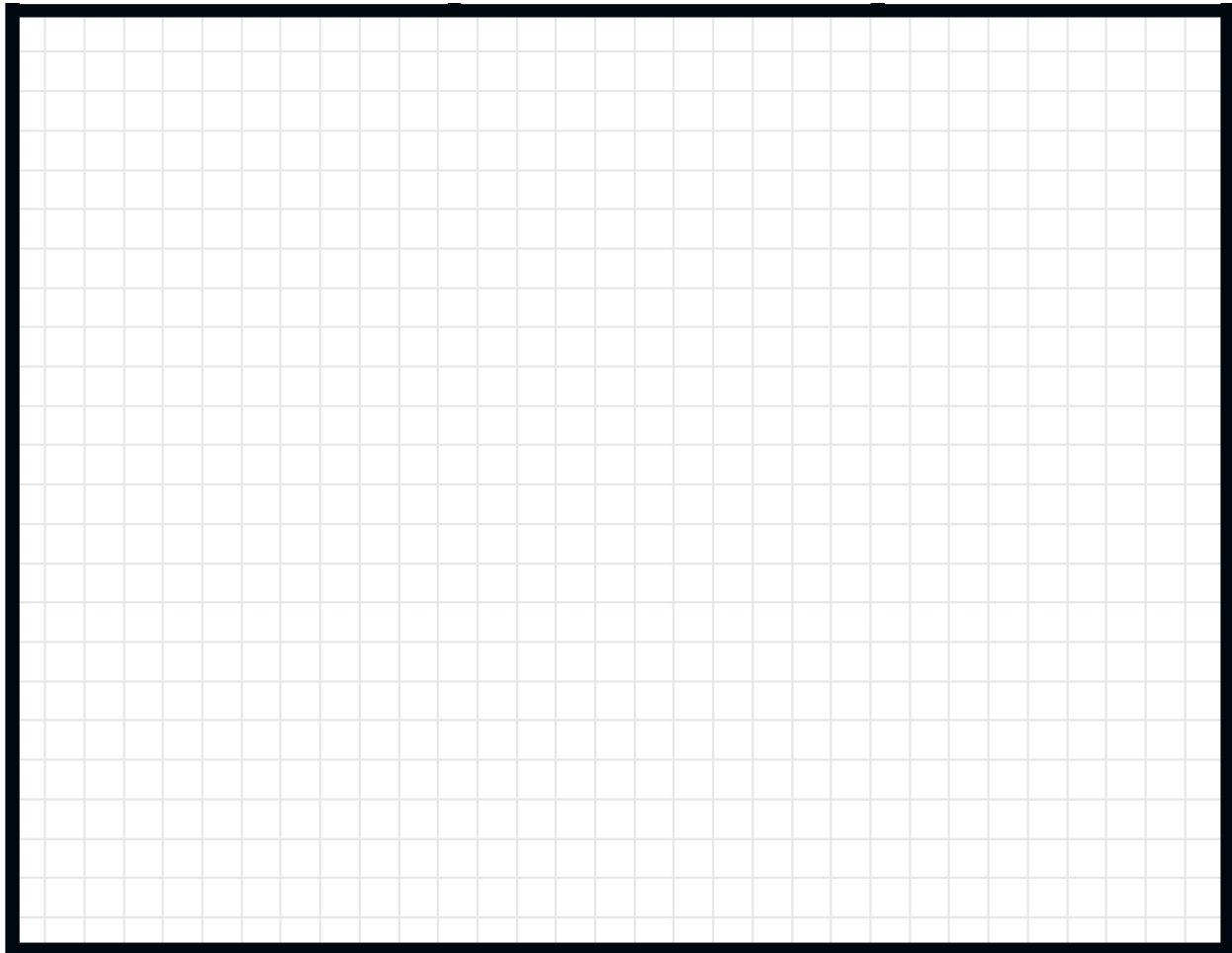

# Style 840 Specs

## Panels, Posts, Doors, Hardware & Finishes

specs

### Standard Color

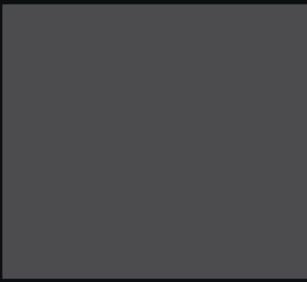

Gray

### Optional Colors



Black



Red



Blue



Safety Yellow



Orange



White



Tan

### PANELS

Panels are constructed of 10 gauge steel wire, woven into 2" x 1" rectangular mesh and securely welded to a 1-1/4" x 1-1/4" x 1/8" steel angle frame. Frames have 7/8" x 7/16" slotted holes for mounting to posts and adjacent panels. Panels four to seven feet wide have one 1/4" x 3/4" stiffener welded to the frame. Wider panels have two stiffeners.

### POSTS

Posts are made of 2" x 2" x 14 gauge (.083) steel tubing. Base plates of 2" x 7" x 1/4" steel flat with two 7/16" round holes for floor anchoring, are welded to each. Top of post is finished with decorative cap. Posts are drilled with 1/2" holes to accept hardware for mounting panels and doors. Hole spacing is set to leave a 3-1/4" sweep space below the panels. Posts have a 2" projection above the panels.

### PLEASE NOTE...

Representation of color is as close as printing techniques allow. Actual color may vary slightly.

### DOORS

Doors are constructed of 10 gauge steel wire, woven into 2" x 1" rectangular mesh and securely welded 1-1/4" x 1-1/4" x 1/8" steel angle frame. Stiffeners, two horizontal and one vertical, of 1/4" x 3/4" steel flat are securely welded to the frame behind the mesh. Two gate posts, hardware, and padlock lugs are supplied with each door. Cylinder locks are available.

### HARDWARE

All erection hardware is supplied. Panel mounting hardware is 3/8" standard thread grade two plated fasteners. Floor anchors are 3/8" wedge type.

### FINISH

Standard finish for non-plated parts is one coat of gray acrylic enamel. Standard Gray Color, Optional In-Stock Colors and Custom Matched Colors are available in polyester-epoxy hybrid powder coat and traditional liquid acrylic enamel finish. Unless otherwise specified all pricing is based on standard gray liquid coating.



SOUTHWEST SOLUTIONS GROUP

*business organization systems*