

SOUTHWEST SOLUTIONS GROUP  
*business organization systems*

- Foodservice Applications
- Material Handling Applications
- Cleanroom Applications
- Electronics Applications
- Retail Applications

# Shelving & Shelving Solutions

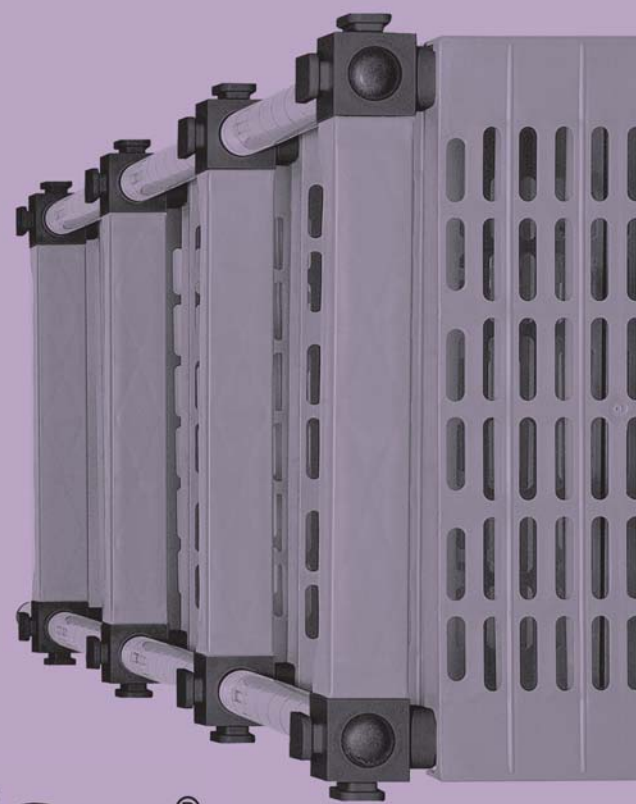

**MICRO GARD®**

**Top-shelf solutions in  
the war against germs.**

# Eagle Wire Shelving



patented  
**QuadTruss®**  
design

The patented Quad-Truss® system makes EAGLE wire shelving products the strongest in the industry.

**EAGLEgard® wire shelving now features MICROGARD® antimicrobial protection**



EAGLEgard® starter unit

## EAGLEgard® with MICROGARD®.

An antimicrobial agent which contains built-in protection to retard the growth of a broad range of bacteria, mold and mildew on the surface of the shelves that cause stains, odors and degradation.



## Valu-Master® Epoxy



## Valu-Gard® Epoxy



## Easy Assembly...

- Numerically calibrated grooved posts, tapered plastic split sleeves and shelf collars combine to make shelving assembly a simple two step process.
  - 1) Snap the split sleeves onto the post over the number of your choice; 2) Slide the shelf collars over the split sleeves. A positive lock between shelf and post is created without the use of any tools.
- Tapered split sleeves of high-temperature-resistant ABS plastic create a positive lock that becomes stronger as the load increases.
- Posts are numbered in 1" increments to ensure fast and level assembly.
- Leveling feet are provided to help compensate for uneven floor surfaces.
- Available in six finishes: EAGLEbrite® sealed with Masterseal® coating for improved rust protection, chrome plating, Valu-Master® pewter grey epoxy, Valu-Gard™ green epoxy, EAGLEgard® with MICROGARD® antimicrobial protection, heavy duty translucent green epoxy finish (also with Masterseal® coating), and stainless steel.



split sleeves

## Finish Warranties

### Stainless Steel finish—OUR BEST

- Stainless steel

NSF-listed for all environments. Type 304 stainless steel. **15 Year Warranty** (NOTE: Stainless Steel shelves are electropolished)

### Eaglegard® hybrid epoxy

- Zinc chloride
- Clear chromate
- MasterSeal® sealer
- Blue green (translucent) hybrid epoxy with MICROGARD®

NSF-listed for all environments. Zinc chloride plating followed by clear chromate plating with MasterSeal® sealer and a hybrid translucent epoxy combined with MICROGARD®. **15 Year Warranty**

### Valu-Master® epoxy

- Phosphate conversion coating
- MasterSeal® sealer
- Pewter gray epoxy

NSF-listed for dry/wet storage and dry heated environments. Phosphate conversion coating with MasterSeal® sealer for improved rust protection, followed by metallic gray epoxy coating. **5 Year Warranty**

### Valu-Gard™ epoxy

- Phosphate conversion coating
- MasterSeal® sealer
- Green (opaque) hybrid metallic epoxy

NSF-listed for dry/wet storage and dry heated environments. Phosphate conversion coating with MasterSeal® sealer for improved rust protection, followed by metallic green epoxy coating. **5 Year Warranty**

### Chrome

- Bright nickel
- Chrome
- Air-dry lacquer

NSF-listed for dry storage and heated environments. Bright nickel plating followed by chrome plating. **1 Year Warranty** (NOTE: Optional clear hybrid epoxy, NSF-listed for all environments, is available.)

### Eaglebrite® zinc

- Zinc chloride
- Clear chromate
- MasterSeal® sealer
- Air-dry lacquer

NSF-listed for dry storage and heated environments. Bright zinc chloride plating followed by clear chromate plating with MasterSeal® sealer for improved rust protection. **3 Year Warranty** (NOTE: Wire shelves feature MasterSeal® sealer. Posts feature air-dry lacquer, NSF-listed for all environments.)

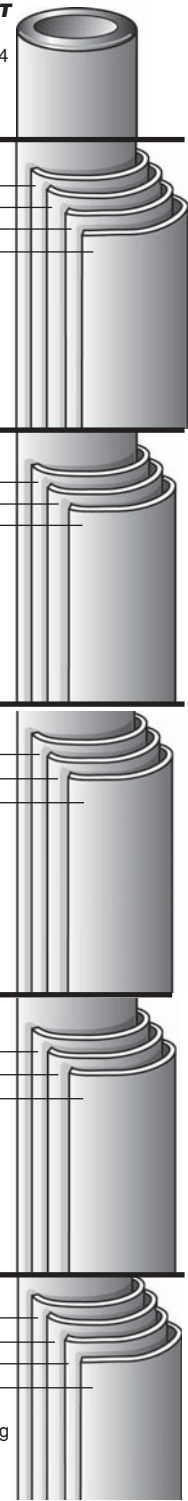

# Eagle Shelving

## Security Units, Solid Shelving, Tank Racks and Dunnage Racks



**1,000 LBS.  
EVENLY DISTRIBUTED  
WEIGHT CAPACITY  
PER SHELF!!**

Quik-Set® solid shelving

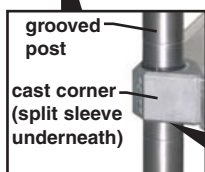

### QUIK-SET® HEAVY DUTY SOLID SHELVING

- Designed specifically for heavy-duty load-bearing capacity.
- Constructed of either 14 or 16 gauge type 300 stainless steel or galvanized steel coated with Valu-Master® pewter gray epoxy (with a five year warranty on the finish).
- Shelves are available in three styles: flat, embossed and louvered.
- Posts are offered in type 300 series stainless steel or Valu-Master® pewter gray epoxy coating (suitable for use in both wet and dry applications).
- 1½" diameter posts are grooved in 2" increments for easy leveling and quick adjustments.
- No tools required for assembly.
- Each post features an adjustable foot or is fitted for optional 5" diameter caster.

### SECURITY UNITS

- Security units are ideal for safely storing and transporting costly materials and items subject to pilferage.
- Heavy-gauge open-wire construction keeps contents visible for quick inventory checks.
- Variety of sizes are available in stationary models or with casters for easy mobility.
- Quick-action locking feature with hasp for padlock.
- All units feature full-access double doors swinging out at approximately 270°.
- Plated finishes include Eaglebrite® zinc, Eaglegard® green epoxy with MICROGARD®, stainless steel or chrome for a durable easy-to-clean finish.
- Add-A-Shelf® Adjustable Shelving Systems available for security cages. See page 8.



mobile security cart

### optional accessories

handles



adjustable feet



post clamps



S-hooks



ledges



dividers

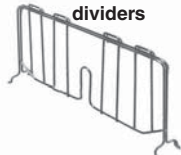

casters



foot plates



hanger rails



Please refer to the Price List for information on additional accessories

### SOLID SHELVING

- Shelves feature aluminum castings which utilize split sleeves.
- Features raised "V" edge on all sides.
- Double-hemmed sides provide strength and quality.
- Shelving remains accessible from all sides, while leveling feet help compensate for uneven flooring surfaces.
- Shelves can be adjusted in 1" increments, allowing you to update your shelving as often as you update your stock.
- Available in 18 gauge type 304 stainless steel or 18 gauge Valu-Master® pewter gray epoxy coated galvanized steel.



solid shelving

### TANK RACKS

- Providing elevated storage for tanks.
- Also available with optional drip pan and cylinders.
- Open-wire construction permits greater air circulation for regulated ventilation in addition to reducing moisture.
- Heavy-gauge open-wire construction for maximum weight loads, while top consists of three sided frame.



tank rack

### DUNNAGE RACKS

- Dunnage racks available: polymer dunnage racks and aluminum dunnage racks.
- All racks provide elevated storage space for excessive loads.
- Available in lengths up to 60".



aluminum dunnage rack



# Eagle Wall Mounted Shelving



Brackets available  
in Chrome,  
Stainless Steel or  
**NEW: Valu-Gard®**

adjustable post wire wall mounts  
(end units shown)  
-wire shelves sold separately



stationary wire wall mounts  
-wire shelf sold separately

- Post wall mounts are ideal where floor space is limited, maximizing storage capacity and minimizing clutter. Especially convenient for mounting over work surfaces.
- Adjustable shelving components are designed to allow the intermixing of shelf widths or customizing of units to fit every specification need.
- Stationary wall mounts are designed and offered complete with mounting brackets, engineered for fixed applications where vertical adjustments are not required.



**WIRE  
SNAP-N-SLIDE™**



- Wire brackets can be mounted to studs – no wall backing required.
- Upturn on rear of shelf and downturn on front of shelf.
- Heavy gauge wire construction.

## Master Trak®

### Overhead Track High-Density Storage System



Master Trak® unit

- Maximum storage in a minimum amount of space.
- Requires only single-aisle access.
- Allows longer track length without a stationary intermediate unit.
- Quick and easy assembly.
- Virtually eliminates floor dirt and debris accumulation.
- Offered in a wide selection of sizes, with shelves (sold separately) ranging from 18" to 36" wide and 24" to 72" long, and overhead track ranging from 6' to 21' long.



**PATENTED  
unique roller  
design**

Now patented, unique roller assembly provide smooth operation without binding, which can occur in other track systems. Patent #5,680,942

## LIFESTOR® Master Trak®

### Polymer Shelving and Overhead Track Storage Combined



LIFESTOR® Master Trak® unit  
shown with optional enclosure  
panel (refer to price list for  
additional accessories)

- Shelves are protected with MICROGARD®, an antimicrobial agent which contains built-in protection to retard the growth of a broad range of bacteria, mold and mildew on the surface of the shelves that cause stains, odors and degradation.
- Features stationary units, mobile unit, and overhead track.
- Smooth polymer shelf surfaces for ease of on-off product removal.
- Quick and easy assembly.
- Removable shelf mats are dishwasher-safe for sanitation.
- Makes cleaning easier with safe access to all units and shelf contents.
- All units include hardware necessary for connecting units to overhead track.
- Overhead track available in lengths ranging from 6' to 21'.

**MICROGARD®**

# Floor-Trak™ High-Density Storage Systems

- Floor-Trak™ system designed for use with wire or LIFESTOR® polymer shelving units.
- Industrial-type bearings allow loaded units to glide effortlessly over track.
- Low profile, non-corrosive track constructed of stainless steel and anodized aluminum.
- Consolidates space.
- The system is ADA compliant.
- Simple and easy to install.
- Can be built double deep and not impede rollability.
- Easy to add-on additional tracks and units.
- Open construction allows for the use of cart covers when required.



single-deep Floor-trak™ system shown with two wire shelving units



single-deep Floor-trak™ system shown with LIFESTOR® shelving unit



double deep unit shown assembled with two wire starter units

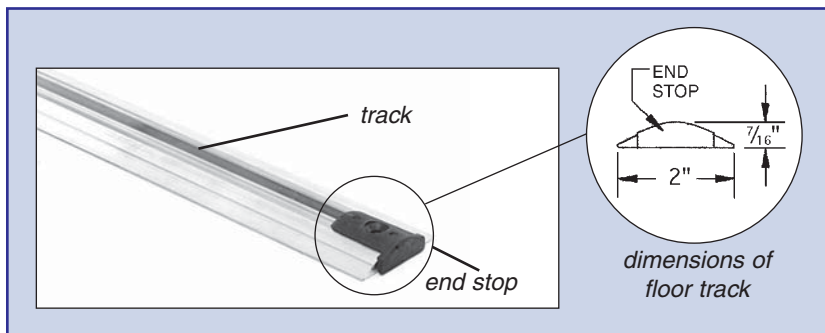

# Eagle WalStor® Wall Systems

*When Space Is Driving You Up the Walls*

- WalStor® Shelving Systems give you the maximum efficiency in storage solutions by putting the "wide open spaces" of your walls to work. Utilizing previously unused wall area for storage, prep or additional work areas.
- When mounted to wall studs, the bracket system allows shelves to be placed off-center while remaining locked into place.
- WalStor® is sway resistant shelving for heavier load ratings.
- Available in Eaglebrite® zinc finish.
- Keep everything within easy reach, without taking up valuable floor space.
- WalStor® allows you to efficiently organize your room with total flexibility.



unequal load capability

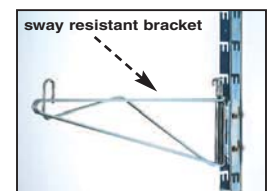

**WALSTOR®**



WalStor® with optional accessories



healthcare



foodservice



material handling



# Eagle Cantilevered Shelving Systems

Designed for Walk-In Coolers, Environmental Rooms and More...

- Adaptable for all areas where storage is needed.
- 100% usable shelving surface, from section to section, wall to wall, and front to back. There are no posts to restrict stock placement. Floor is unobstructed.
- Infinite height adjustability, no slots or keyholes to line up for leveling. Shimming is eliminated.
- Wall-mounted shelving requires no support from the floor. Floor area is therefore open and easily maintained.
- For use with both standard wire and solid shelving.
- All components are made of heavy gauge material and available in zinc, aluminum and stainless steel.
- Heavy-duty, rugged construction.

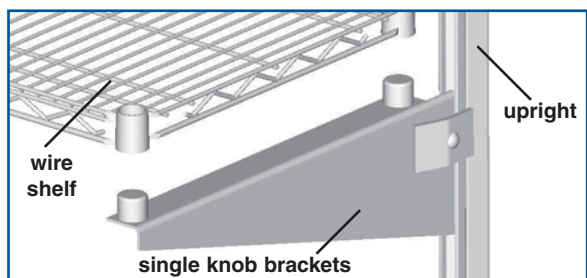

view shows wire shelving

cantilevered system shown with wire shelving

## Can Racks & Can Rack Systems

- Can racks are front-loading, front-dispensing, and gravity fed, each with a capacity of eight #10 cans or twelve #5 cans.
- Made of chrome plated mild steel and heavy gauge wire, can racks fit on 24"-wide shelves.
- Can rack systems offered are 3-tier units, 4-tier units, and units with bottom dunnage shelf.

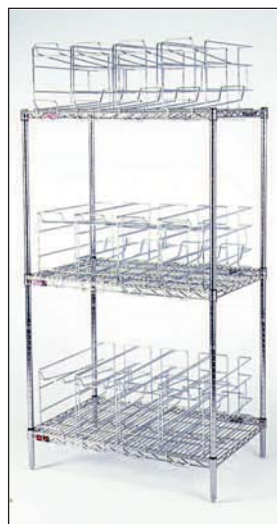

# Eagle LIFESTOR® Polymer Shelving

- LIFESTOR® Polymer Shelves are protected with MICROGARD®, an antimicrobial agent which contains built-in protection to retard the growth of a broad range of bacteria, mold and mildew on the surface of the shelves that cause stains, odors and degradation.\*
- LIFESTOR® Polymer Shelving components allow a wide variety of layouts to fit available space and to meet each customer's individual storage needs. This versatile system allows for the easy addition, removal or adjustment of intermediate shelves, requiring only one person, without disassembling the unit.
- The combination of 304 stainless steel or clear epoxy posts and rails, plus high-density polymer shelving sections and fittings, provides a heavy duty unit that's virtually non-corrosive.
- LifeStor® polymer shelf sections are available in either solid or louvered, and are easily removable for thorough cleaning in automatic dish washing machines.
- All materials are suitable for food service use, and the entire system complies with NSF Standards for all conditions, including low-temperature freezer rooms.

\* This product does not protect users or others against bacteria, viruses, germs or other disease organisms. Always clean this product thoroughly after each use.



corner unit



louvered shelving

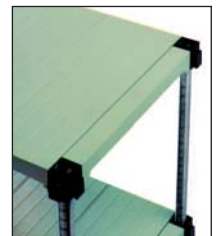

solid shelving



removable shelf section

starter unit

## LifeStor® assembly



1.

Mount connector on post by placing split sleeve on groove and slipping connector over sleeve.



2.

Attach side braces between posts to create ladder.



3.

Attach rails between ladders to complete structure. Place shelf sections on rails.

## MICROGARD®

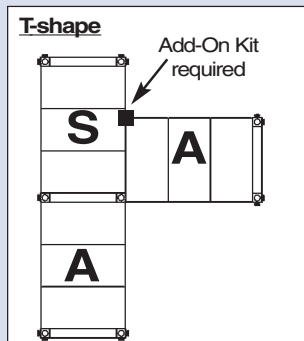
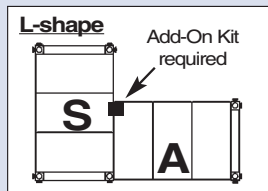
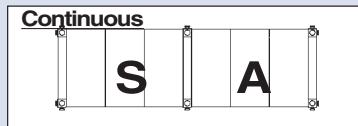

Configurations available for LIFESTOR® starter (S) and add-on (A) units

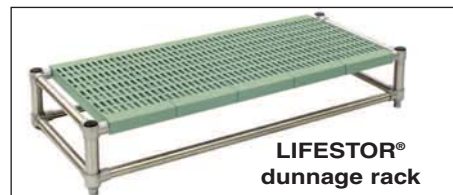

LIFESTOR® dunnage rack



# Eagle Add-A-Shelf® Adjustable Shelving Systems



Add-A-Shelf® unit



Add-A-Shelf® with Eagle's security unit...



...or use as a merchandise display unit

Unique Patented Design!

- Add to your existing shelving without having to dismantle the top shelf.
- Special collar allows user to add or remove a shelf without disassembling entire unit.
- Available in four different widths - 14", 18", 21" and 24".
- Numerically calibrated grooved posts, plastic split sleeves and shelf collars combine to make shelving assembly a simple three-step process (see below).
- Variety of finishes available including white, red & black epoxy, chrome and Eaglebrite® zinc.

## Add-A-Shelf® assembly

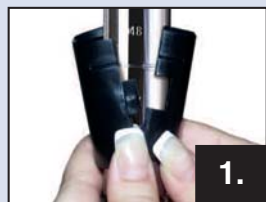

1.

Snap the split sleeves onto a post over the number of your choice.



2.

Slide the Add-A-Shelf® collar over the split sleeves. When the collar is together, a positive lock is created without the use of any tools.

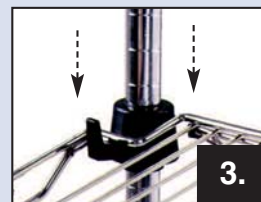

3.

Place shelf over collar to complete assembly.



## ...Self-Serve Shelving Display

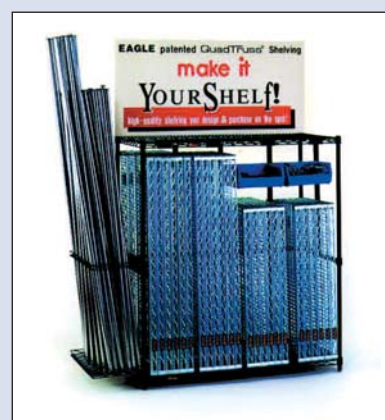

Dimensions: 59"W x 25½"D x 78½"H



# Eagle AdjusTable® Work Surface Systems



basic AdjusTable® unit

**adjusTable®**  
'Customize your Work Surface'



electronics workstation

Allows you to create work surfaces of your choice with single or multiple cantilevered overhead or wire overshelf systems.



1-tier wire overshelf unit

A stainless steel table top/work surface, unsurpassed in the industry for quality. The four chrome posts are numbered in 1" increments for flexible and level positioning of the two chrome wire undershelves.

Create an unlimited number of custom configurations by adding additional wire or solid stainless steel undershelves, H-frame or C-frame, chrome wire overshelves or solid stainless steel overshelves.

A variety of options available including utility drawers, cantilever shelves, reel holders, bench power centers, bin holders, and dividers allow for complete customization to fit your needs.

## various configurations of AdjusTable® available

Eagle workstations are flexible and can be adapted when field conditions change. An unlimited number of configurations are available to fit your unique requirements, and even more configurations can be created utilizing accessories and options.



food prep station

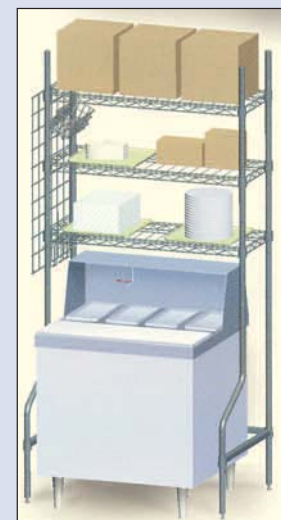

sandwich prep station



2-tier cantilever overhead unit

# Eagle Mobile Shelving Systems

EAGLE offers hundreds of differently configured mobile shelving systems for virtually any application.

Carts can be altered to meet changing requirements. By adding or removing accessories, any number of combinations can be made to customize any cart for a specific use.

The open-wire construction promotes higher visibility by allowing light to pass through the shelves, permits greater air circulation reducing dust and contamination buildup, and increases the effectiveness of fire-suppression systems.



stem caster cart

## STEM CASTER CARTS AND DOLLY TRUCKS

- Our patented Quad-truss® design makes shelves up to 25% stronger, providing you with the strongest carts in the industry.
- Sturdy, mobile four shelf unit available in either mirror chrome or Eaglebrite® zinc finish.
- Dolly truck comes with complete wraparound bumper.



dolly truck

## ANGLED SHELF CARTS

- Increase product visibility of quick-moving merchandise.
- This unit allows you to adjust and re-adjust shelf heights and angle variances.
- Sturdy, mobile four-shelf unit available in either mirror chrome, Valu-Master® gray epoxy or Eaglebrite® zinc finish.



angled shelf cart

## UTILITY CARTS

- Patented Quad-truss® design makes our shelves up to 25% stronger and provides a retaining ledge for increased storage stability and product retention.
- Individual units available with two wire shelves, three wire shelves or two wire and one solid shelf.
- Finishes offered are mirror chrome or Eaglebrite® zinc finish.



utility cart

## TOTE BOX CARRIERS

- Accommodates a wide variety of containers.
- Each tote box carrier comes with two brake and two swivel casters.
- Comes standard with three sets of tote box slides constructed of 16 gauge chrome plated steel.
- One-, two-, or three-bay carrier models available with standard resilient or poly casters.



tote box carrier

## BENCHSIDE TOTE BOX CARRIERS

- Ergonomically designed for repetitive pick-and-pack activity.
- Features angled shelf with built-in ledge and flat undershelf.
- 5"-diameter resilient casters – two with brake.
- Offered in lengths ranging from 24" to 60".



benchside tote box carrier

# Eagle Cleanroom Applications

EAGLE's cleanroom line offers wire shelving with superior strength - while at the same time allowing for 62% laminar flow.

Eagle offers the preferred transport and storage vehicle by providing numerous ergonomic and visual advantages, and does not hold particulation. Numerous options allow customization for any environment or situation.

The open-wire construction promotes higher visibility by allowing light to pass through the shelves, permits greater air circulation reducing dust and contamination buildup, and increases the effectiveness of fire-suppression systems.



roll bag dispenser

## PERFORATED GOWNING BENCH

- Perforated solid top with wire undershelf provides superior laminar flow.
- Wire undershelves offer optional bootie storage.
- Optional dividers and additional wire shelves.
- Available in No. 4 brushed or electropolished finish.



perforated gowning bench

## ROLL BAG DISPENSER

- Standard unit features two 14" x 48" wire shelves, one 3-sided channel frame, eight removable dispensing bars, and four post with 30" outrigger feet.
- Dispenser bars are adjustable on 1" increments.
- Available in stainless steel or chrome finish.

## WIRE FREESTANDING GOWNING RACKS

- These racks incorporate standard wire shelving components with specially designed gown storage options.
- They offer a more economical rack option in less demanding environments.
- Racks available in chrome or electropolished stainless steel.



wire gowning rack



shoe rack

## SHOE RACK

- Wire shelves offer the optimum combination of laminar flow and ventilation for the storage of cleanroom shoes.
- Rods & tabs run through shelves to create cubbies for each pair of shoes.
- Available finishes are chrome and electropolished stainless steel.

## CLEANROOM TABLES

- Available with solid or perforated tops, brushed or electropolished finish. All tops are 14 gauge type 304 stainless steel, alcohol-wiped and cleanroom-bagged.
- Available with H-frame or C-frame bases.
- Tables are shipped knocked-down, reducing freight costs and the possibility of freight damage.



cleanroom table with perforated top



# Eagle Electronics Applications



electronic tray cart  
full size - side load model  
with optional ESD trays



gravity flow line feed cart



computer workstation shown  
with optional swivel mouse  
pad and decorative casters

## ELECTRONIC TRAY CARTS

- Offers a practical and economical method of transporting or storing conductive trays.
- These knock-down units feature zinc-plated wire shelves, chrome posts and aluminum split sleeves.
- End-load and side-load racks available in half or full size and all models roll on 5" resilient swivel casters.

## VIBRATION DAMPENING TRAY CART

- Provides maximum benefits in vibration transfer, ESD-safe, and cost.
- Vibration transfer is dramatically reduced via polyurethane 50 shore A casters with expander stems, 5" swivel, two with brake.
- All models feature front and rear tray locks to ensure product safety.

## GRAVITY FLOW LINE FEED CARTS

- Offers the ergonomic advantage of an angled shelf along with added visibility in the storage bins.
- Available for stationary or mobile applications.
- Flexibility to adjust shelves on 1" vertical increments and to adjust the slope of each shelf.

## STENCIL SHELF UNIT

- Zinc finish, and includes one bottom and one top partitioned shelf.
- Each shelf has (15) 2" partitions.
- Stencil shelves may be used with numerous combinations of posts and casters to meet your specific needs.

## MOBILE COMPUTER WORKSTATION

- Eagle's patented Quad-truss® design makes shelves up to 25% stronger and provides a retaining ledge for increased stability and product retention.
- Optional swivel mouse pad can be mounted on user's right/left side.
- Offered in chrome or stainless finish.



vibration dampening  
tray cart, half size - end  
load model  
with optional ESD trays

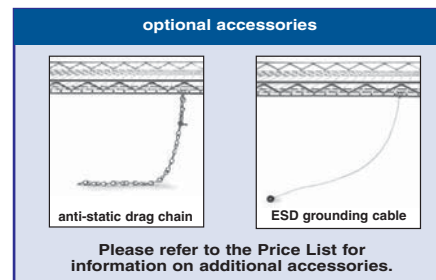

two tiers of stencil  
shelves shown in mobile  
unit configuration

## Custom Configurations Available

Available through Eagle's SpecFAB® Division, a division formed to fill the gap between standard equipment and high-cost, wish-and-wait for highly customized equipment. SpecFab® provide a way to short-cut the design and fabrication process. Depending on the customers needs, we can build custom configurations from scratch or design superior pre-fab pieces from existing components. This flexibility means we can deliver custom equipment faster and at a lower cost to you!

# Eagle Healthcare Applications



catheter procedure cart

## CATHETER PROCEDURE CARTS

- Patented Quad-truss® design makes shelves up to 25% stronger and provides a retaining ledge for increased storage, stability and product retention.
- Carts are capable of holding all sizes and styles of catheter packages. Hooks, shelves, and tote boxes give you the versatility to create the ideal system for your requirements.
- All components are adjustable. Shelves are vertically adjustable on 1" increments, while the hook and bar assemblies can be adjusted to accommodate peel pouches 3" or greater in width. Bars are readily removable. All casters are swivel type, and feature polyurethane tread. Two casters are provided with brakes.



linen cart

## LINEN CARTS

- Standard models offered are equipped with four wire and one solid shelf mounted on an industry standard frame.
- Heavy-duty models offered are equipped with four wire shelves and one solid shelf mounted on a heavy-duty dolly frame, and include side and back enclosure panels.
- Carts can be altered readily to meet changing requirement by adding or removing accessories.
- All components have chrome-plated finish. Posts are chrome-plated over 16 gauge stainless steel, ensuring stability in any use.

## SUTURE CARTS

- Suture unit is available with four or five adjustable wire shelves, which can be adjusted up or down in 1" increments without the use of tools. Slope of shelves is also adjustable from 0° to 30° by raising or lowering front or back truss brace.
- The special self-feeding design of the slanted shelves provides quick, easy access to stored materials.
- Open-wire construction for easy identification.



suture cart



exchange cart

## EXCHANGE CARTS

- Versatile exchange carts come with various shelving configurations, caster styles and accessory packages.
- The open-wire construction promotes higher visibility and requires light assembly.
- Shelving can be adjusted up and down by 1" increments for optimum cart configuration.
- All components have chrome plated finish.

## INHALATION THERAPY CART

- Constructed with the patented Quad-truss® design and chrome plating, this item conforms to NFPA 99.
- Includes four UL-recognized 5" conductive casters.
- Racks are plastic coated and accommodate twelve "D" or "E" cylinders.



inhalation therapy cart



# Eagle Standouts™ Display Shelving

## Creative Retail Display Concepts.

- Show off your merchandise when you use our wire display shelving units in various configurations highlighted by thirteen brilliant finishes plus chrome.
- Open wire grid shelf allows maximum merchandise versatility.
- Open wire construction also provides the ventilation required for items such as stereo, electronic and computer equipment.
- Minimal dust buildup.
- Easy to assemble.
- Adjust shelf spacing in seconds.
- Various post heights available.
- Choose from standard and custom colors.
- Color coordinated accessories create fully functional merchandising unit.
- Custom configurations available.

### GONDOLA WIRE SHELVING



pharmacy display

### GONDOLA INSET SHELVING



hardware display

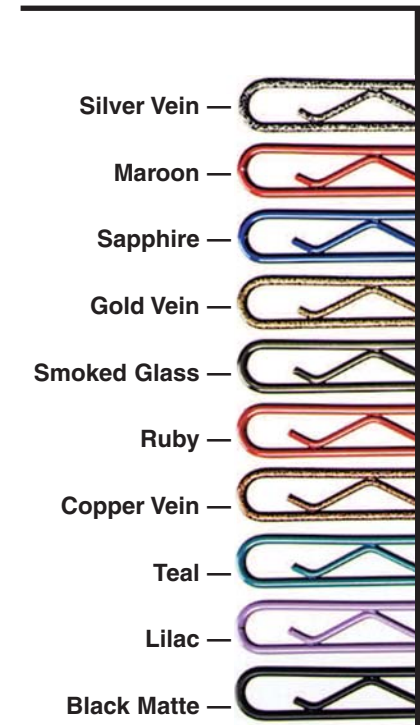
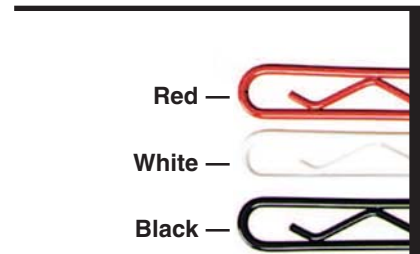

### SHELVING RACKS

#### SHELVING CARTS



chrome utility cart



chrome utility cart

#### POINT-OF-PURCHASE DISPLAYS



with maple top and Quad-truss® shelving

#### SECURE DISPLAY MERCHANDISER



with low-voltage lighting and wall grid panel





# Eagle Retail Display Shelving



cradle wine shelves

## CRADLE WINE SHELVES

- Convert your existing shelving by adding cradle wine shelves.
- These shelves “cradle” each bottle via heavy gauge wire for stability.
- Open-wire construction keeps contents visible for quick inventory checks.
- Shelves are 14” wide and are offered in lengths of 36” and 48”.
- Available in black epoxy or chrome plated finish.



bulk wine shelf unit

## BULK WINE SHELF UNITS

- Largest capacity offered in the industry for bulk storage.
- Each compartment is adjustable for bottle diameter and holds one dozen bottles per compartment.
- Bottles are retained with removable dividers, back panels. Panels are chrome plated steel.
- Shelves — available in black epoxy or chrome plated finish — are 14” wide and are offered in lengths of 36” and 48”. Height of all units is 74”.
- Available with or without security doors.

## WIRE DISPLAY SHELVING

- Used primarily for gondolas and designed for use on all major shelving fixtures.
- Shelf brackets are one-piece, tier-notched to hold display shelf securely, and can be positioned horizontally or slanted.
- Shelves hold up to 40 lbs. per linear foot and feature EAGLEbrite® with MasterSeal® coating for improved rust protection. Available in 3’ and 4’ lengths, and up to 20” width.
- Wall standards and dividers are available.



gondola with wire display shelving



four plate display shelves and posts  
(shown assembled)

## PLATE DISPLAY SHELVING

- Designed for plates and china to be displayed upright by resting on built-in ledges, wire shelves allow for smaller items to be displayed as well.
- Open wire construction helps prevent dust build-up.
- Shelves available in black epoxy finish and can be assembled into units using additional posts, or shelves can be added to existing Eagle shelving.
- Patented Quad-truss® design makes shelves up to 25% stronger and provides a retaining ledge for increased storage stability and product retention.

## EAGLE shelf - 1860 shelf shown

EAGLE shelves incorporate more serpentine trusses (both perimeter and interior) and mat continuity support wires than any competitive shelf, which translates into more strength per shelf.

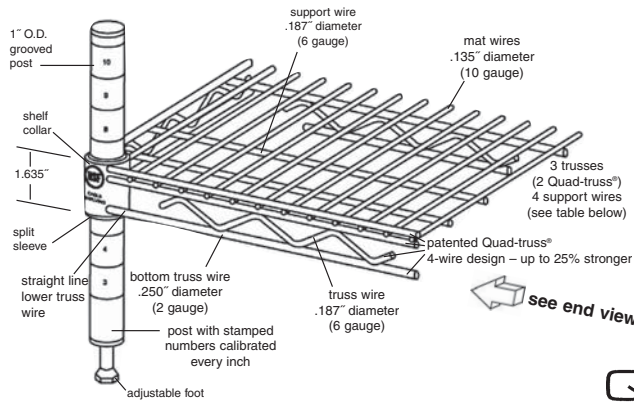

EAGLE's patented Quad-truss® design uses four truss wires for up to 25% greater strength!!!

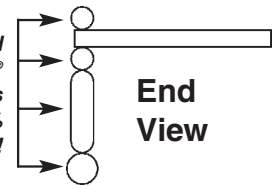

The EAGLE advantage — strength, reliability, value

patented  
**QuadTruss®**  
design  
(patent #5,390,803)

The patented Quad-truss® system makes EAGLE wire shelving products the strongest in the industry.

In addition, the mat on an EAGLE shelf utilizes a Quad-truss® pincer-type design with the mat wire sandwiched between the two top truss wires, adding significant strength and distributing the entire load without stress and strain on the welds.

Deflection tests conducted under laboratory conditions show that EAGLE patented shelving is up to 25% stronger than competing wire shelving products.

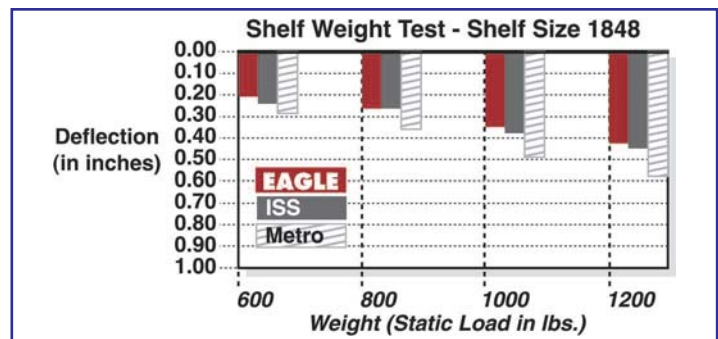

Static Load in Lbs	600 lbs	800 lbs	1000 lbs	1200 lbs
Static Load in Kg	272.2 kg	362.9 kg	453.6 kg	544.3 kg
<b>EAGLE</b>	0.204	0.259	0.343	0.415
ISS	0.211	0.260	0.360	0.430
Metro	0.278	0.349	0.476	0.575

SOUTHWEST **SOLUTIONS** GROUP  
*business organization systems*