

SOUTHWEST SOLUTIONS GROUP  
*business organization systems*

NEW ITEMS

- Lab Sinks
- Lab Workstations
- S/S Countertops
- Custom Fabrication

Solutions for

# Cleanroom & Lab

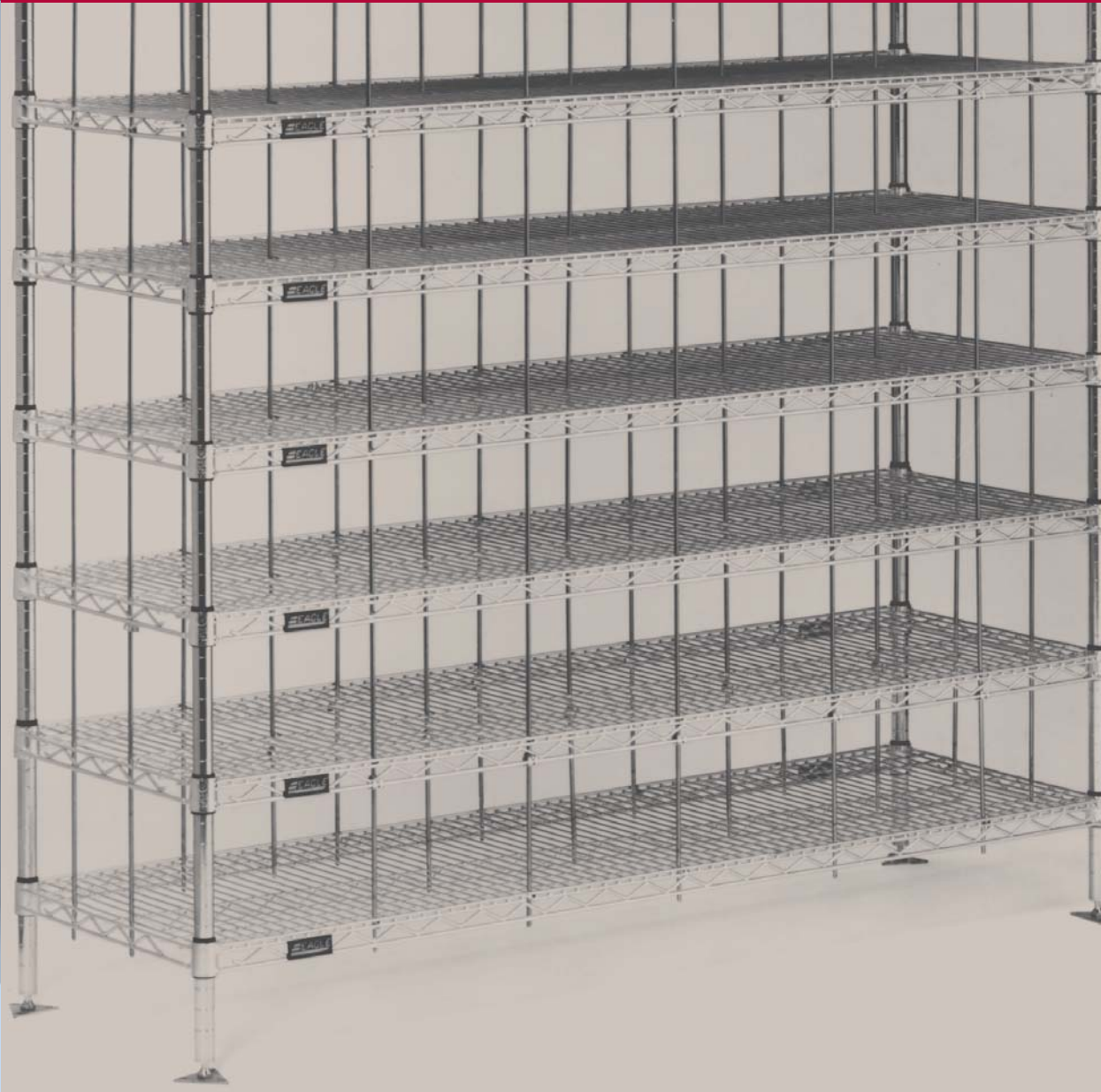

## Gowning Racks

These racks are designed for efficient storage of garments in the cleanroom. Available in stainless steel or electropolished finished. The stainless steel construction offers a non-contaminating surface that eliminates particle shedding. The electropolished models feature electrochemically passivated surfaces, for the most demanding requirements. Racks are available in width of 24", length from 48" to 84", and height 75". Hanger slots are standard 3" centers. Other center configurations are available.



single  
(shown with optional hangers)



double  
(shown with optional hangers)



cantilevered  
(shown with optional hangers)

## Gowning Racks with Wire Shelving Components

These racks incorporate standard wire shelving components with specially designed gown storage options. They offer a more economical rack option in less demanding environments. Available in chrome-plated steel as well as electropolished stainless steel models. Available width of 14" and 24", length from 48" to 72", and height of 86".



hanger slots on  
2 1/2" (64mm) centers  
(shown with optional hangers)

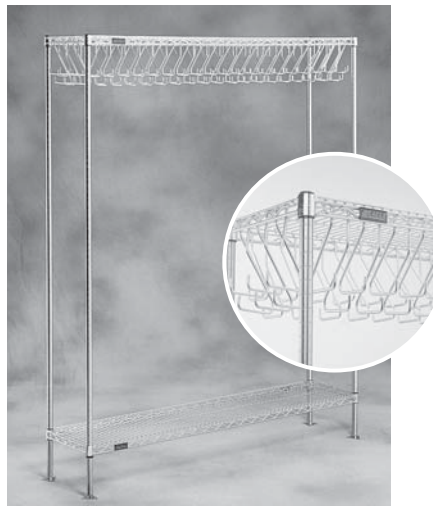

hooks on 1 1/2" (38mm) centers on all four  
shelf sides



1" (25mm)-diameter tubular bar  
mounted underneath wire shelf  
(shown with optional hangers)

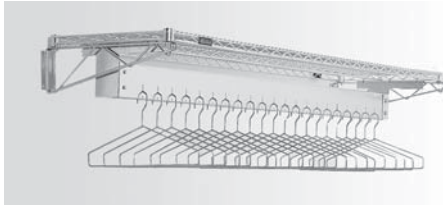

racks with hanger slots  
(shown with optional hangers)



racks with hooks



racks with hanger tube

## Wall-Mounted Gowning Racks 'Space Management Solutions'

### Racks with Hanger Slots

This gowning rack is available in lengths of 48" [15 hangers], 60" [19 hangers], or 72" [23 hangers] and width of 24". Wall mounted, and includes open wire top shelf for laminar flow. Available in electropolished stainless steel or chrome finish. Hangers are optional.

### Racks with Hooks

This compact design is 14" in width and comes in lengths of 48" [30 hooks], 60" [38 hooks] or 72" [45 hooks]. Available in electropolished or chrome finish.

### Racks with Hanger Tube

Like the freestanding model, this model features a 1" diameter tubular bar which mounts easily to underside of wire shelf and comes in width of 18" and lengths of 48", 60", and 72". Wire design facilitates laminar flow. Available in electropolished or chrome finish.

## Hangers and Hanger Bar Kits

### Open Loop Hangers

For all gowning rack models that employ hangers. Available in chrome, brush finish, or electropolished stainless steel.

### Two-Piece Hangers

For use with non-removable hanger models. The top component is affixed to the gowning rack, while the bottom component is removable for convenient mounting of the garment. Available in chrome, brush finish, or electropolished stainless steel.

### Closed Loop Hangers

For use with tubular gowning racks. Hangers are not removable from rack. Available in chrome, brush finish, or electropolished stainless steel.

### Hanger Bar Kits

Used to retrofit existing shelving into freestanding or wall-mounted gowning racks. Hanger slots on 2 1/2" centers. 24" shelf width required. Available in chrome, brush finish, or electropolished stainless steel.

### Wall Mount Tubular Rack

Rack employs both closed loop hangers and open loop hangers. Available in stainless steel and chrome. Width 18", and length ranges from 48" to 72".

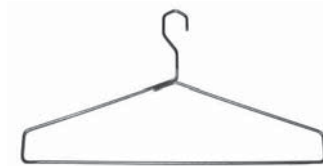

open loop hanger



two-piece hanger



closed loop hanger



hanger bar kits-  
shown with optional hangers

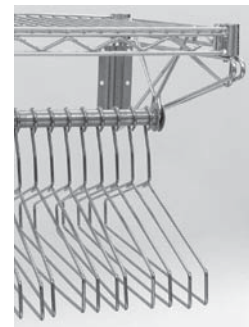

wall mount tubular rack -  
shown with optional hangers



solid gowning bench

## Gowning Benches

### Solid Gowning Bench

Heavy-duty benches include flanged stainless steel foot plates for convenient attachment to the floor. Available in brushed 304 stainless steel or electropolished finish. Widths of 9" and 12", lengths up to 84", and height of 17".

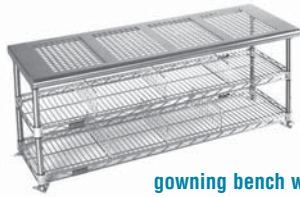

gowning bench with standard undershelf (shown with optional additional shelf and dividers)

### Gowning Bench with Undershelf Storage

Available with perforated or solid seat. Wire undershelves offer optional bootie storage. These units come complete with designated seat, legs, foot plates, and one wire undershelf (additional wire shelves and dividers are optional). Available in No. 4 electropolished or brushed finish. Seating area is 18" wide, and wire undershelf is 14" wide. Length up to 72" and height of 19".



wire gowning bench

### Wire Gowning Bench

Economical gowning bench with wire shelving components offers 62% laminar flow. Ideal for less demanding environments or for use during construction as the room is brought into clean. All units feature four 18" legs with foot plates, one three-sided channel frame, and one wire shelf. Available in 14" width, 18" height and lengths up to 72".

## Carts and Wire Units

Open wire construction promotes higher visibility and permits greater air circulation, which reduces dust and contamination build-up. QuadTruss® design makes shelves up to 25% stronger. Posts are numbered on vertical 1" increments to ensure, fast, level assembly of shelves and maximum flexibility for unit/cart configuration. Numerous sizes and combinations are available.



stem caster cart



wire shelving unit



angled wire shelf cart



2-shelf utility cart

## Security Units

Security unit is 14" to 30" in width, length of 39¼" to 61¼", and the height 69". This unit is ideal for storing and transporting valuable materials. Security units are offered in chrome or electropolished stainless steel finish. Stationary and mobile units available.



mobile security unit

## Adjustable Post Wire Wall Mount Shelf System

The adjustable wall mount provides wall storage and facilitates laminar flow. Use with standard wire shelves (sold separately). Designed to hold up to four tiers. The shelf widths range from 14" to 24" and the post height range from 14" to 63". Available in chrome and stainless steel.

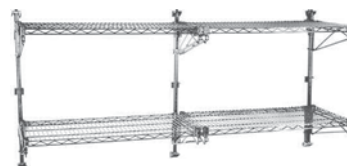

adjustable post wire wall mount systems (shown with standard wire shelves)

## adjuSTable® Overhead System

Eagle's adjuSTable® Overhead System allows you to create work surfaces enhanced with single or multiple overshelves. Each work system comes with two 33" posts, two 63" posts, and your choice of the following table bases: two C-frames; two H-frames; one C-frame and one wire shelf; or one H-frame and one wire shelf. The available sizes are 24" width and 36" or 48" length. Work surfaces are available with solid or perforated tops, brushed or electropolished. Cantilevered shelves are offered in stainless steel or chrome finish and are sold separately. Optional keyboard and utility drawers are available.



C-frame adjuSTable® with overhead system



C-frame adjuSTable® with cantilever overhead system and optional drawer

## adjuSTable® Work Surface System

Eagle's adjuSTable® System allows you to create work surfaces in the configuration of your choice. Each work surface system comes with four 33" posts and your choice of the following bases: two C-frames; two H-frames; one C-frame and one wire shelf; or one H-frame and one wire shelf. Work surfaces are available with solid or perforated tops, brushed or electropolished. Available sizes are 24" or 30" for width and 36" to 60" in length. Table bases are available in chrome or stainless steel. Optional keyboard and utility drawers are available.



H-frame adjuSTable®

## Tables

Type 304 stainless steel tables are available with solid or perforated tops, brushed or electropolished finish. All perforated tops have  $\frac{3}{4}$ " perforations on 1" centers, allowing for 40% laminar flow. Available in standard widths of 24", 30", and 36" and lengths from 36" to 96". Custom sizes available upon request. All cleanroom tables are alcohol-wiped and cleanroom bagged. Standard table bases are C-frame or H-frame in brushed or electropolished finish. Undershelves are available on request.

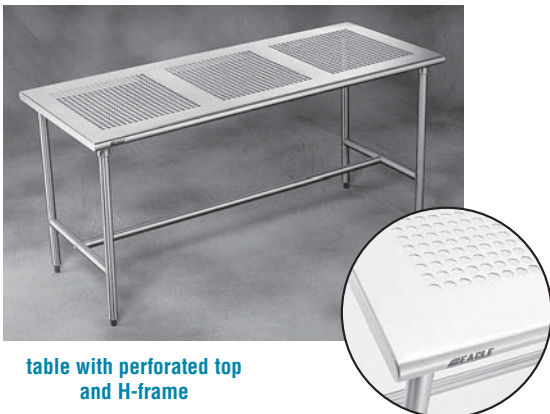

table with perforated top and H-frame



table with solid top and C-frame

## Workstations

### Mobile Computer Workstations

Open wire workstation allows for laminar flow. Reduces moisture and dust build-up. Comes with standard keyboard drawer. Mouse shelf is optional. Available in chrome or stainless steel finish. Dimensions are 24" width, 53 $\frac{3}{4}$ " overall height, 24" length and optional 5" casters.

### Stationary Workstations

Workstation with open wire construction offer 62% laminar flow with up to 800-lb. loadbearing capacity. Available in electropolished stainless steel or chrome finish. Available in standard widths from 24" through 72" and depths of 18", 21", 24" and 30". Optional keyboard drawer available.

### Mobile Workstations

Eagle's mobile workstations allow for easy relocation of stations as needed. Features four 5" poly stem casters (two with brake). Overshelves are height-adjustable in 1" increments for flexible and accurate placement without the use of tools. Width is 24" and length 36" to 48". Available in stainless steel or chrome finish. Optional keyboard drawer available.



mobile computer workstation



stationary workstation



mobile workstation shown with solid shelf and optional keyboard drawer



vertical storage cabinet

## Vertical Storage Cabinets

Features 18-gauge stainless steel cabinet body. Three shelves are adjustable on 4" vertical centers, double pan 20-gauge stainless steel hinged doors, and transverse rod handles featuring keyed locks are standard. Available in 36" and 48" lengths. Flat top or slanted top models available. Optional 5" plate casters with brake available.

## Roll Bag Dispensers

Provides an effective means of dispensing rolls of bags or film. An easy way to establish protocol, by color of cleanroom waste, avoiding inadvertent mixing of non-compatible items. Standard unit consists of two 14" x 48" wire shelves, one 3-sided channel frame, eight removable dispensing bars and four 74" posts with 30" outrigger feet for stability. Dispensing bars are adjustable on 1" increments. Available in stainless steel or chrome finish. Unit measures 30" wide, 48" length, and 75" height. Casters available for mobile applications. Custom sizes also available.



roll bag dispenser

## Shoe Racks

Wire shelves offer the optimum combination of laminar flow and ventilation for the storage of cleanroom shoes. Rods and tabs run through the shelves to create cubbies for each pair of shoes. Optional snap-on plastic shelf markers are available for identification of each storage unit. Available finishes are chrome and electropolished stainless steel. Foot plates are included for fastening the unit to the floor. 14" width, ranging in lengths from 24" to 72", and up to 86" in height.

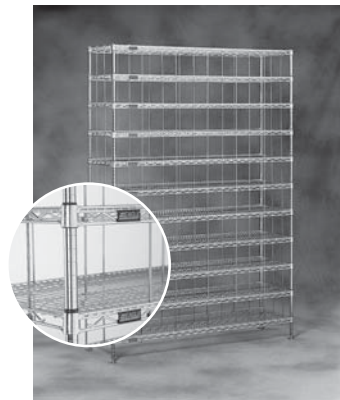

shoe rack

## Lab Workstations

Spec-Master® workstations feature a 14 or 16 gauge stainless steel top. All workstations are available with an adjustable stainless steel undershelf or tubular base. Left and right ends are turned down 90° providing a flat surface so tables can be placed end to end. Sound deadening insulation tape runs between hat channel and table top. All workstations feature our patented uni-lok® system which provides greater strength and a bullnose edge on front and rear (without backsplash).



SE series



SE-BS series



STE series



STE-BS series

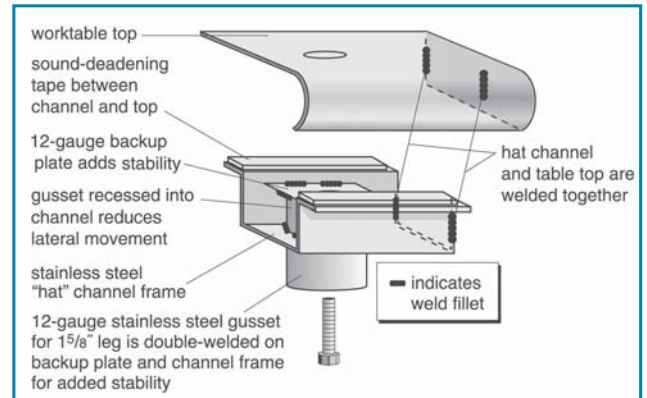

## Tables with Sinks

Eagle tables with sinks are available through our SpecFAB® Division. Select a solid top table and choose an appropriate sink size. We have standard sizes and single bowl sink locations to help reduce cost and lead times. Backsplashes are available in standard 4<sup>1</sup>/<sub>2</sub>" or 6" size. Customize your table with end splashes, optional edges, splash sizes and/or cutouts.

### Standard Sink Locations

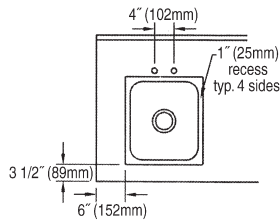

sink on left/right side of countertop

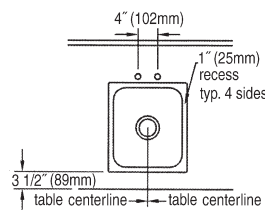

sink on center of countertop

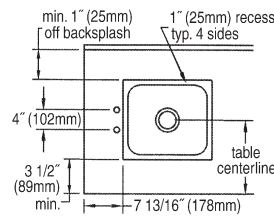

sink with faucet on end of countertop



FN series sink (shown with drainboards)



314 series sink (shown with drainboards)

## Lab Sinks

### FN Series Sinks

14 gauge stainless steel throughout. All bowls are 14" deep and have 5/8" radius corners, both vertical and horizontal. Legs are crossbraced front-to-back and side-to-side to increase stability. Standard 10" backsplash and include a 1" upturn. Sinks come standard in one, two, three, or four compartments with or without drainboards.

### 314 Series Sinks

Deep drawn sinks have a generous radius and are rectangular for maximum capacity. Legs are galvanized, 1<sup>5</sup>/<sub>8</sub>" diameter and welded adjacent to sink bowl for maximum stability and support.

### Counter Drop-in Self Rim

All units are 304 series stainless steel and come standard with mounting hardware, swivel faucet, and 1<sup>1</sup>/<sub>2</sub>" basket drain. Available in one, two and three compartment.



counter drop-in self rim

### Hand Sinks

Hand sinks are type 304 stainless steel all-welded construction. Deep-drawn, one-piece, seamless bowls. Models vary from the traditional hand sink with faucet to the electronic hand sink with soap and towel dispenser and hot water heater. Available in wall mount and pedestal type models.



HSA-10-FE

## Stainless Steel Countertops - Standard

Stainless steel countertops are made of 16 gauge type 304. Standard sizes and single bowl sink locations help reduce cost and lead times. Standard backsplashes are available in 4" x 45° with downturn and z-clips. Available with stainless steel hat channels or with 3/4"-thick marine plywood. Customize your countertop with endsplashes, optional edges, splash sizes and/or cutouts.



### Standard Dimensions

width - 30"  
lengths - 36" thru 144"

### Standard Backsplash

4" x 45° with turndown and z-clip

### Standard Front Edges

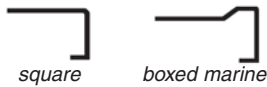

## Details and Specifications

- Die formed on state of the art equipment.
- Constructed to sanitation standards.
- Infinite configurations available.
- Excellent resistance to wide range of chemicals.
- Excellent stain resistant properties.
- Exceeds most load capacities.
- Recommended for use with fume hoods.
- Long-term value.



## Stainless Steel Countertops - Custom Configurations

Custom configurations are designed to fit your precise needs. Countertops can include one-, two-, or three-compartment sink bowls placed in the center, left or right end.

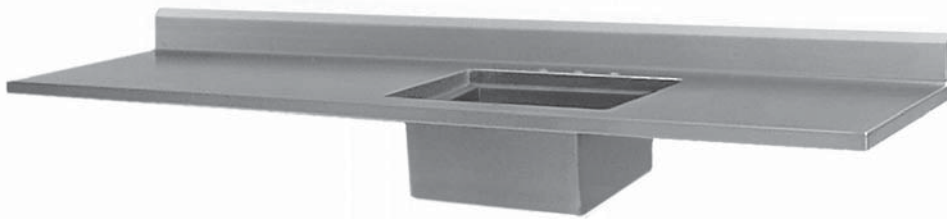

stainless steel countertop with optional sink centered and square edge

