

LIBRARY

S H E L V I N G

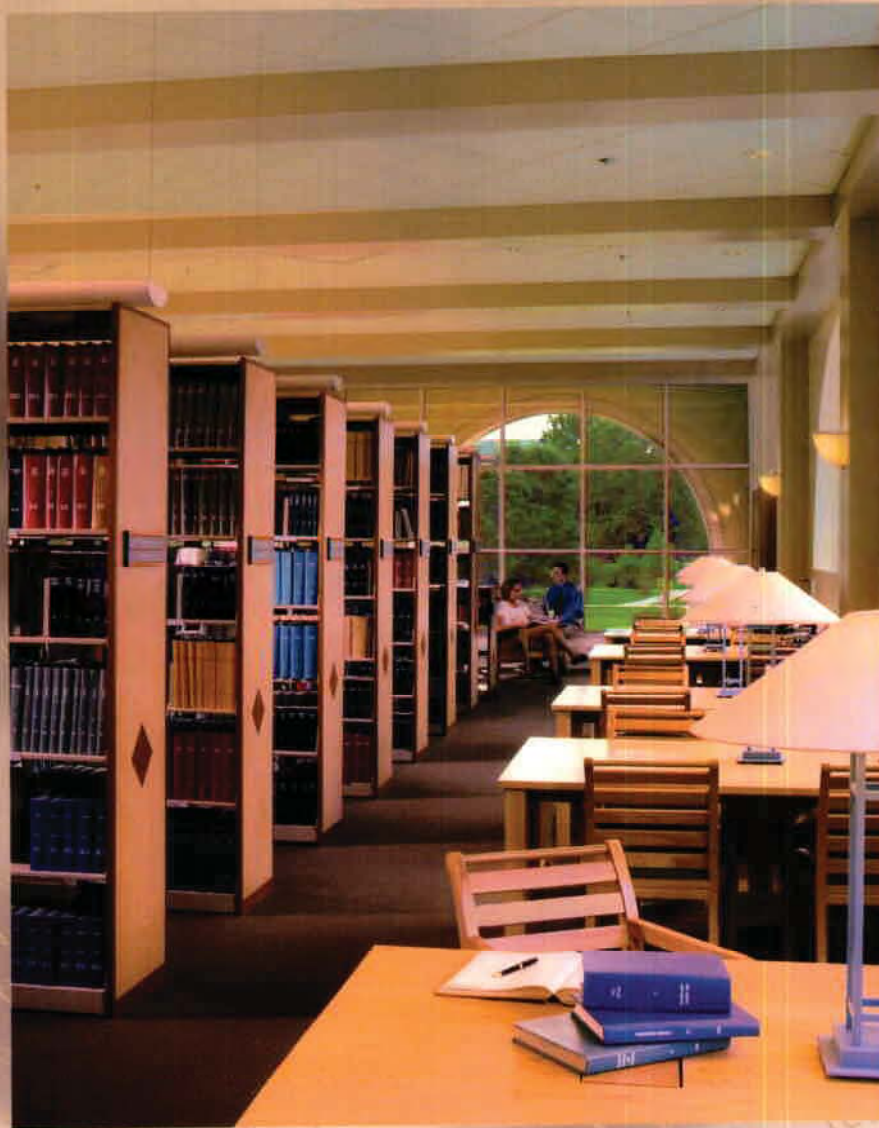

Shelving & Display Systems For The Library Environment

www.southwestsolutions.com

Toll Free 1-800-803-1083



SOUTHWEST SOLUTIONS GROUP
business organization systems



Academic library plans for future growth.



Spacesaver shelving accommodates Oblique Library Systems (hanging compartments.)



TABLE OF CONTENTS

Page

<i>Bookstack Assemblies / Mobile</i>	1-2
<i>Divider Type Assemblies / Mobile</i>	3-4
<i>Bookstack Assemblies / Static</i>	5-6
<i>Divider Type Assemblies / Static</i>	7-8
<i>Display Units</i>	9
<i>Frames & Supports</i>	10-11
<i>Base Shelves</i>	12
<i>Adjustable Shelves</i>	12-13
<i>Specialty Shelves</i>	13-14
<i>Accessories</i>	15-17
<i>Options</i>	17-19

For nearly thirty years, Spacesaver has been a pioneer in the storage industry, earning forty patents and thousands of satisfied customers along the way. Today, thousands of libraries around the world rely on us for consistent quality, shelf after shelf, frame after frame.

Whether school, academic, special, or public, we have the experience to respond creatively and comprehensively to your library's needs. Today, you not only need to shelve media, but also display and merchandise it. We are continually expanding our line of specialty shelves and accessories to keep up with the demands of today – and tomorrow.

At some point you may need to reconfigure – that's where Spacesaver Library Shelving products really pay off. Every shelf, frame and accessory is made to the strictest standards to ensure simple reassembly. And since Spacesaver shelving is designed for static and mobile configurations, you can achieve maximum capacity no matter how you arrange your library.

ASSEMBLY NUMBERING SYSTEM

The assembly part numbering system for Spacesaver Cantilever Library Shelving Products describes the individual assembly in detail. This system will simplify your ordering and provide a quick reference to the size of related parts included in an assembly.

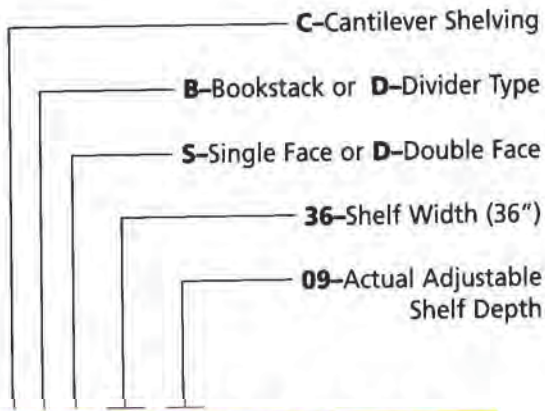

CBS36090990S1G

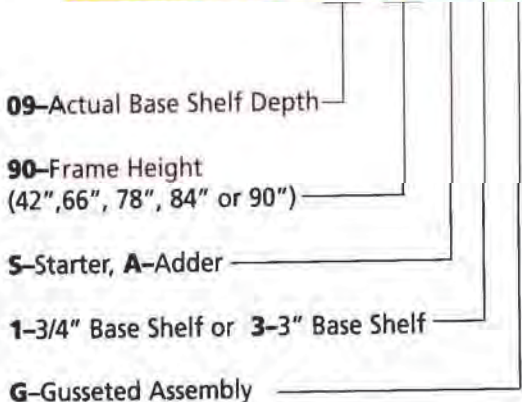

MOBILE GUSSETED UNITS (For use on Spacesaver mobile carriages.)

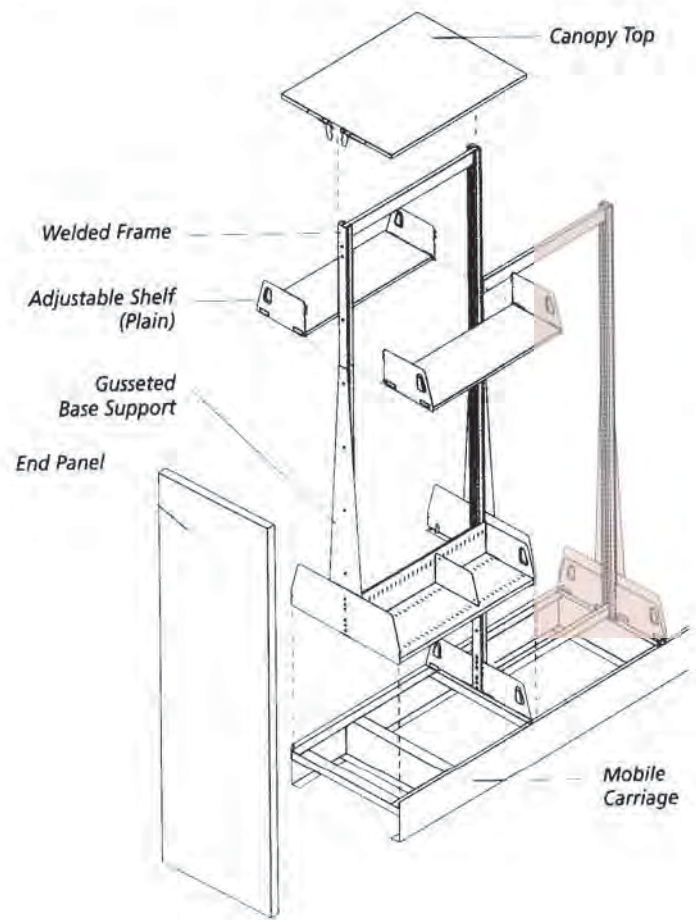

ACTUAL vs. NOMINAL DIMENSIONS
 All shelf depth dimensions in the catalog number are actual. For library nominal dimensions, add 1" to the actual depth. See diagram below.

SINGLE FACE & DOUBLE FACE PLAN VIEW DIMENSIONS

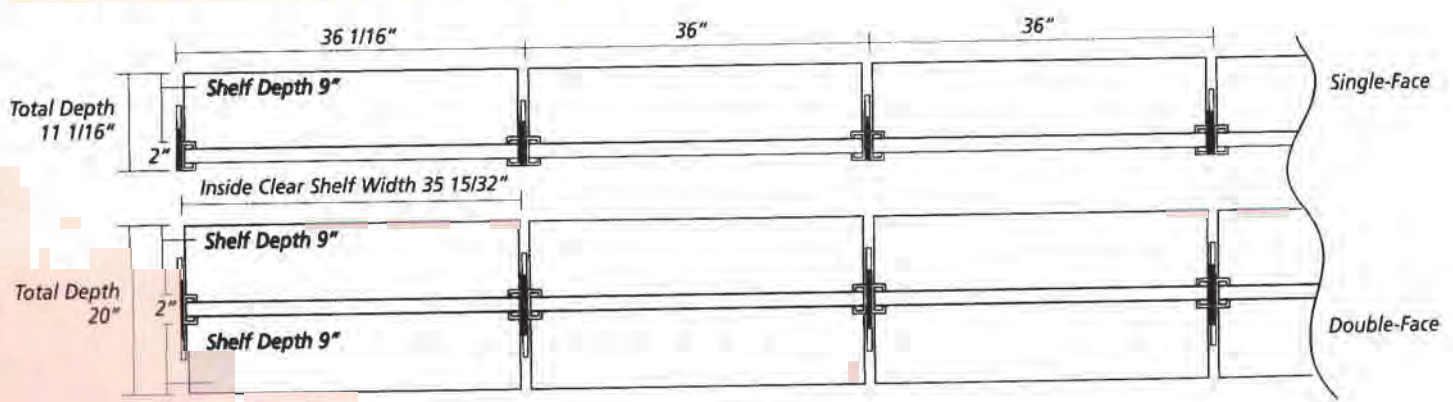

BOOKSTACK ASSEMBLIES / MOBILE

SINGLE FACE (Starter Assemblies)



OPENINGS	ACTUAL SHELF DEPTH	ACTUAL BASE SHELF DEPTH	OVERALL UNIT DEPTH	CATALOG NO.
78" HIGH				
6	7"	7"	9"	CBS36070778S1G
6	7"	9"	11"	CBS36070978S1G
6	8"	8"	10"	CBS36080878S1G
6	8"	9"	11"	CBS36080978S1G
6	9"	9"	11"	CBS36090978S1G
6	9"	11"	13"	CBS36091178S1G
6	11"	11"	13"	CBS36111178S1G
84" HIGH				
7	7"	7"	9"	CBS36070784S1G
7	7"	9"	11"	CBS36070984S1G
7	8"	8"	10"	CBS36080884S1G
7	8"	9"	11"	CBS36080984S1G
7	9"	9"	11"	CBS36090984S1G
7	9"	11"	13"	CBS36091184S1G
7	11"	11"	13"	CBS36111184S1G
90" HIGH				
7	7"	7"	9"	CBS36070790S1G
7	7"	9"	11"	CBS36070990S1G
7	8"	8"	10"	CBS36080890S1G
7	8"	9"	11"	CBS36080990S1G
7	9"	9"	11"	CBS36090990S1G
7	9"	11"	13"	CBS36091190S1G
7	11"	11"	13"	CBS36111190S1G

SINGLE FACE (Adder Assemblies)

If an Adder Assembly is desired, change the suffix "S" to "A" when ordering, e.g.: CBS36070790A1G.

NOTE:

- Single Face Starter Assemblies include two (2) Gusseted Base Supports, whereas, Single Face Adder Assemblies include one (1) Gusseted Base Support on the right end.
- Assemblies do not include Canopy Top, or Levelers.
- Assemblies only available in 36" widths. If 24" or 30" wide units are desired, this must be done using component catalog numbers.
- For other heights, consult factory.
- All shelf depth dimensions in the catalog number are actual. For library nominal dimension, add 1" to actual depth.
- All single face units must be anchored to the floor, platform, wall or overhead.

DOUBLE FACE (Starter Assemblies)

OPENINGS	ACTUAL SHELF DEPTH	ACTUAL BASE SHELF DEPTH	OVERALL UNIT DEPTH	CATALOG NO.
78" HIGH				
6	9"	9"	20"	CDD36090978S1G
6	9"	11"	24"	CDD36091178S1G
6	9"	12"	26"	CDD36091278S1G
6	10"	10"	22"	CDD36101078S1G
6	11"	11"	24"	CDD36111178S1G
6	12"	12"	26"	CDD36121278S1G
6	12"	15"	32"	CDD36121578S1G
6	15"	15"	32"	CDD36151578S1G
84" HIGH				
7	9"	9"	20"	CDD36090984S1G
7	9"	11"	24"	CDD36091184S1G
7	9"	12"	26"	CDD36091284S1G
7	10"	10"	22"	CDD36101084S1G
7	11"	11"	26"	CDD36111184S1G
7	12"	12"	26"	CDD36121284S1G
7	12"	15"	32"	CDD36121584S1G
7	15"	15"	32"	CDD36151584S1G
90" HIGH				
7	9"	9"	20"	CDD36090990S1G
7	9"	11"	24"	CDD36091190S1G
7	9"	12"	26"	CDD36091290S1G
7	10"	10"	22"	CDD36101090S1G
7	11"	11"	24"	CDD36111190S1G
7	12"	12"	26"	CDD36121290S1G
7	12"	15"	32"	CDD36121590S1G
7	15"	15"	32"	CDD36151590S1G

DOUBLE FACE (Adder Assemblies)

If an Adder Assembly is desired, change the suffix "S" to "A" when ordering, e.g. CDD36121584A1G.

NOTE:

- Divider-type Assemblies include five (5) Dividers per shelf.
- Double Face Starter Assemblies include two (2) Gusseted Base Supports, whereas, Double Face Adder Assemblies include one (1) Gusseted Base Support on the right end.
- Assemblies only available in 36" widths. If 24" or 30" wide units are desired, this must be done using component catalog numbers.
- For other heights, consult factory.
- All shelf depth dimensions in the catalog number are actual. For library nominal dimension, add 1" to actual depth.
- Assemblies do not include Canopy Top, or Levelers.



BOOKSTACK ASSEMBLIES / STATIC**SINGLE FACE (Starter Assemblies)**

OPENINGS	ACTUAL SHELF DEPTH	ACTUAL BASE SHELF DEPTH	OVERALL UNIT DEPTH	CATALOG NO.
42" HIGH				
3	7"	7"	9"	CBS36070742S3
3	7"	9"	11"	CBS36070942S3
3	8"	8"	10"	CBS36080842S3
3	8"	9"	11"	CBS36080942S3
3	9"	9"	11"	CBS36090942S3
3	9"	11"	13"	CBS36091142S3
3	11"	11"	13"	CBS36111142S3
66" HIGH				
5	7"	7"	9"	CBS36070766S3
5	7"	9"	11"	CBS36070966S3
5	8"	8"	10"	CBS36080866S3
5	8"	9"	11"	CBS36080966S3
5	9"	9"	11"	CBS36090966S3
5	9"	11"	13"	CBS36091166S3
5	11"	11"	13"	CBS36111166S3
78" HIGH				
6	7"	7"	9"	CBS36070778S3
6	7"	9"	11"	CBS36070978S3
6	8"	8"	10"	CBS36080878S3
6	8"	9"	11"	CBS36080978S3
6	9"	9"	11"	CBS36090978S3
6	9"	11"	13"	CBS36091178S3
6	11"	11"	13"	CBS36111178S3
84" HIGH				
7	7"	7"	9"	CBS36070784S3
7	7"	9"	11"	CBS36070984S3
7	8"	8"	10"	CBS36080884S3
7	8"	9"	11"	CBS36080984S3
7	9"	9"	11"	CBS36090984S3
7	9"	11"	13"	CBS36091184S3
7	11"	11"	13"	CBS36111184S3
90" HIGH				
7	7"	7"	9"	CBS36070790S3
7	7"	9"	11"	CBS36070990S3
7	8"	8"	10"	CBS36080890S3
7	8"	9"	11"	CBS36080990S3
7	9"	9"	11"	CBS36090990S3
7	9"	11"	13"	CBS36091190S3
7	11"	11"	13"	CBS36111190S3

SINGLE FACE (Adder Assemblies)

If an Adder Assembly is desired, change the suffix "S" to "A" when ordering, e.g.: CBS36091184A3.

NOTE:

- Single Face Starter Assemblies include two (2) Base Supports, whereas, Single Face Adder Assemblies include one (1) Base Support on the right end.
- Assemblies do not include Canopy Top, or Levelers.
- All single face units must be anchored to the floor, wall or overhead.
- Assemblies only available in 36" widths. If 24" or 30" wide units are desired, this must be done using component catalog numbers.
- For other heights, consult factory.
- All shelf depth dimensions in the catalog number are actual. For library nominal dimension, add 1" to actual depth.
- Includes Base Filler.

DOUBLE FACE (Starter Assemblies)

OPENINGS	ACTUAL SHELF DEPTH	ACTUAL BASE SHELF DEPTH	OVERALL UNIT DEPTH	CATALOG NO.
42" HIGH				
3	7"	7"	16"	CBD36070742S3
3	7"	9"	20"	CBD36070942S3
3	8"	8"	18"	CBD36080842S3
3	8"	9"	20"	CBD36080942S3
3	9"	9"	20"	CBD36090942S3
3	9"	11"	24"	CBD36091142S3
3	11"	11"	24"	CBD36111142S3
66" HIGH				
5	7"	7"	16"	CBD36070766S3
5	7"	9"	20"	CBD36070966S3
5	8"	8"	18"	CBD36080866S3
5	8"	9"	20"	CBD36080966S3
5	9"	9"	20"	CBD36090966S3
5	9"	11"	24"	CBD36091166S3
5	11"	11"	24"	CBD36111166S3
78" HIGH				
6	7"	7"	16"	CBD36070778S3
6	7"	9"	20"	CBD36070978S3
6	8"	8"	18"	CBD36080878S3
6	8"	9"	20"	CBD36080978S3
6	9"	9"	20"	CBD36090978S3
6	9"	11"	24"	CBD36091178S3
6	11"	11"	24"	CBD36111178S3
84" HIGH				
7	7"	7"	16"	CBD36070784S3
7	7"	9"	20"	CBD36070984S3
7	8"	8"	18"	CBD36080884S3
7	8"	9"	20"	CBD36080984S3
7	9"	9"	20"	CBD36090984S3
7	9"	11"	24"	CBD36091184S3
7	11"	11"	24"	CBD36111184S3
90" HIGH				
7	7"	7"	16"	CBD36070790S3
7	7"	9"	20"	CBD36070990S3
7	8"	8"	18"	CBD36080890S3
7	8"	9"	20"	CBD36080990S3
7	9"	9"	20"	CBD36090990S3
7	9"	11"	24"	CBD36091190S3
7	11"	11"	24"	CBD36111190S3



DOUBLE FACE (Adder Assemblies)

If an Adder Assembly is desired, change the suffix "S" to "A" when ordering, e.g.: CBD36070990A3

NOTE:

- Double Face Starter Assemblies include two (2) Base Supports, whereas, Double Face Adder Assemblies include one (1) Base Support on the right end.
- It is recommended that all units over 78" tall be anchored to the floor or overhead (per local codes and/or requirements).
- Assemblies only available in 36" widths. If 24" or 30" wide units are desired, this must be done using component catalog numbers.
- For other heights, consult factory.
- All shelf depth dimensions in the catalog number are actual. For library nominal dimension, add 1" to actual depth.
- Includes Base Filler.
- Assemblies do not include Canopy Top, or Levelers.

DIVIDER-TYPE ASSEMBLIES / STATIC



SINGLE FACE (Starter Assemblies)

OPENINGS	ACTUAL SHELF DEPTH	ACTUAL BASE SHELF DEPTH	OVERALL UNIT DEPTH	CATALOG NO.
----------	--------------------	-------------------------	--------------------	-------------

42" HIGH

3	9"	9"	11"	CDS36090942S3
3	9"	11"	13"	CDS36091142S3
3	9"	12"	14"	CDS36091242S3
3	10"	10"	12"	CDS36101042S3
3	11"	11"	13"	CDS36111142S3
3	12"	12"	14"	CDS36121242S3
3	12"	15"	17"	CDS36121542S3
3	15"	15"	17"	CDS36151542S3

66" HIGH

5	9"	9"	11"	CDS36090966S3
5	9"	11"	13"	CDS36091166S3
5	9"	12"	14"	CDS36091266S3
5	10"	10"	12"	CDS36101066S3
5	11"	11"	13"	CDS36111166S3
5	12"	12"	14"	CDS36121266S3
5	12"	15"	17"	CDS36121566S3
5	15"	15"	17"	CDS36151566S3

78" HIGH

6	9"	9"	11"	CDS36090978S3
6	9"	11"	13"	CDS36091178S3
6	9"	12"	14"	CDS36091278S3
6	10"	10"	12"	CDS36101078S3
6	11"	11"	13"	CDS36111178S3
6	12"	12"	14"	CDS36121278S3
6	12"	15"	17"	CDS36121578S3
6	15"	15"	17"	CDS36151578S3

84" HIGH

7	9"	9"	11"	CDS36090984S3
7	9"	11"	13"	CDS36091184S3
7	9"	12"	14"	CDS36091284S3
7	10"	10"	12"	CDS36101084S3
7	11"	11"	13"	CDS36111184S3
7	12"	12"	14"	CDS36121284S3
7	12"	15"	17"	CDS36121584S3
7	15"	15"	17"	CDS36151584S3

90" HIGH

7	9"	9"	11"	CDS36090990S3
7	9"	11"	13"	CDS36091190S3
7	9"	12"	14"	CDS36091290S3
7	10"	10"	12"	CDS36101090S3
7	11"	11"	13"	CDS36111190S3
7	12"	12"	14"	CDS36121290S3
7	12"	15"	17"	CDS36121590S3
7	15"	15"	17"	CDS36151590S3

SINGLE FACE (Adder Assemblies)

If an Adder Assembly is desired, change the suffix "S" to "A" when ordering, e.g.: CDS36121584A3.

NOTE:

- Divider-type Assemblies include five (5) Dividers per shelf.
- Single Face Starter Assemblies include two (2) Base Supports, whereas, Single Face Adder Assemblies include one (1) Base Support on the right end.
- All Single Face units must be anchored to the floor, wall or overhead.
- Assemblies only available in 36" widths. If 24" or 30" wide units are desired, this must be done using component catalog numbers.
- For other heights, consult factory.
- All shelf depth dimensions in the catalog number are actual. For library nominal dimension, add 1" to actual depth.
- Assemblies do not include Canopy Top, or Levelers.

DOUBLE FACE (Starter Assemblies)

OPENINGS	ACTUAL SHELF DEPTH	ACTUAL BASE SHELF DEPTH	OVERALL UNIT DEPTH	CATALOG NO.
42" HIGH				
3	9"	9"	20"	CDD36090942S3
3	9"	11"	24"	CDD36091142S3
3	9"	12"	26"	CDD36091242S3
3	10"	10"	22"	CDD36101042S3
3	11"	11"	24"	CDD36111142S3
3	12"	12"	26"	CDD36121242S3
3	12"	15"	32"	CDD36121542S3
3	15"	15"	32"	CDD36151542S3
66" HIGH				
5	9"	9"	20"	CDD36090966S3
5	9"	11"	24"	CDD36091166S3
5	9"	12"	26"	CDD36091266S3
5	10"	10"	22"	CDD36101066S3
5	11"	11"	24"	CDD36111166S3
5	12"	12"	26"	CDD36121266S3
5	12"	15"	32"	CDD36121566S3
5	15"	15"	32"	CDD36151566S3
78" HIGH				
6	9"	9"	20"	CDD36090978S3
6	9"	11"	24"	CDD36091178S3
6	9"	12"	26"	CDD36091278S3
6	10"	10"	22"	CDD36101078S3
6	11"	11"	24"	CDD36111178S3
6	12"	12"	26"	CDD36121278S3
6	12"	15"	32"	CDD36121578S3
6	15"	15"	32"	CDD36151578S3
84" HIGH				
7	9"	9"	20"	CDD36090984S3
7	9"	11"	24"	CDD36091184S3
7	9"	12"	26"	CDD36091284S3
7	10"	10"	22"	CDD36101084S3
7	11"	11"	24"	CDD36111184S3
7	12"	12"	26"	CDD36121284S3
7	12"	15"	32"	CDD36121584S3
7	15"	15"	32"	CDD36151584S3
90" HIGH				
7	9"	9"	20"	CDD36090990S3
7	9"	11"	24"	CDD36091190S3
7	9"	12"	26"	CDD36091290S3
7	10"	10"	22"	CDD36101090S3
7	11"	11"	24"	CDD36111190S3
7	12"	12"	26"	CDD36121290S3
7	12"	15"	32"	CDD36121590S3
7	15"	15"	32"	CDD36151590S3



DOUBLE FACE (Adder Assemblies)

If an Adder Assembly is desired, change the suffix "S" to "A" when ordering, e.g.: CDD36121584A3.

NOTE:

- Divider-type Assemblies include five (5) Dividers per shelf.
- Double Face Starter Assemblies include two (2) Base Supports, whereas, Double Face Adder Assemblies include one (1) Base Support on the right end.
- It is recommended that all units over 78" tall be anchored to the floor or overhead (per local codes and/or requirements).
- Assemblies only available in 36" widths. If 24" or 30" wide units are desired, this must be done using component catalog numbers.
- For other heights, consult factory.
- All shelf depth dimensions in the catalog number are actual. For library nominal dimension, add 1" to actual depth.
- Assemblies do not include Canopy Top, or Levelers.

DISPLAY UNITS

PERIODICAL DISPLAY & STORAGE UNITS (with Hinged Display Shelves)



Sloped 14" hinged display shelves combined with flat 12" deep storage shelves.

Sloped 14" hinged display shelves combined with flat 12" storage shelves.

SINGLE FACE (Starter Assemblies)

HEIGHT	DISPLAY SHELVES	STORAGE SHELVES	OVERALL UNIT DEPTH	CATALOG NO.
66"	4	4	15-1/4"	CHPS361466S3
78"	5	5	15-1/4"	CHPS361478S3
84"	5	5	15-1/4"	CHPS361484S3
90"	6	6	15-1/4"	CHPS361490S3

DOUBLE FACE (Starter Assemblies)

HEIGHT	DISPLAY SHELVES	STORAGE SHELVES	OVERALL UNIT DEPTH	CATALOG NO.
66"	8	8	28-1/2"	CHPD361466S3
78"	10	10	28-1/2"	CHPD361478S3
84"	10	10	28-1/2"	CHPD361484S3
90"	12	12	28-1/2"	CHPD361490S3

SINGLE & DOUBLE FACE (Adder Assemblies)

If an Adder Assembly unit is desired, change the suffix "S" to "A" when ordering, e.g. CHPS361466A3.

NOTE:

- The vertical opening between the flat shelf and the hinged display shelf (in the open position) is 6" clear.
- When 24" or 30" wide units are desired, please order using component catalog numbers.

SLOPING DISPLAY UNITS



For merchandising assorted media (i.e., best sellers, VHS tapes, etc.). Shelves are 8" deep actual.

SINGLE FACE (Starter Assemblies)

HEIGHT	LEVEL SHELVES	SLOPED SHELVES	CATALOG NO.
42"	0	3	CSDS360842S
66"	2	3	CSDS360866S
84"	3	4	CSDS360884S
90"	3	4	CSDS360890S

DOUBLE FACE (Starter Assemblies)

HEIGHT	LEVEL SHELVES	SLOPED SHELVES	CATALOG NO.
42"	0	6	CSDD360842S
66"	4	6	CSDD360866S
84"	6	8	CSDD360884S
90"	6	8	CSDD360890S

SINGLE & DOUBLE FACE (Adder Assemblies)

If an Adder Assembly is desired, change the suffix "S" to "A" when ordering, e.g. CSDS360866A.

NOTE:

- If End Panels are used, consult factory for End Panel width dimension.

FRAMES AND SUPPORTS

WELDED FRAMES

Accepts all shelves and accessory items. Adjustable on 1" increments.
No sway braces to inhibit oversized media from passing center line of bookstack.

FRAME HEIGHT	CATALOG NO.*
42"	CWF-4236
66"	CWF-6636
78"	CWF-7836
84"	CWF-8436
90"	CWF-9036

NOTE:

- *24" or 30" widths are available. Change the catalog number accordingly, e.g.: CWF-8430.
- Special heights available.



SEISMIC WELDED FRAMES

Accepts all shelves and accessory items. Adjustable on 1" increments.
May be adapted to meet all seismic requirements.*

FRAME HEIGHT	CATALOG NO.**
78"	CWF3-7836
84"	CWF3-8436
90"	CWF3-9036

NOTE:

- *Additional horizontal spreaders available.
- **24" and 30" widths are available. Change the catalog number accordingly, e.g.: CWF3-8430.
- Special heights available.



BASE SUPPORTS

Single face Base Supports must be specified left or right.

SINGLE FACE

OVERALL SUPPORT DEPTH	LEFT END CATALOG NO.*	RIGHT END CATALOG NO.*
8"	CSB-6L	CSB-6R
9"	CSB-7L	CSB-7R
10"	CSB-8L	CSB-8R
11"	CSB-9L	CSB-9R
12"	CSB-10L	CSB-10R
13"	CSB-11L	CSB-11R
14"	CSB-12L	CSB-12R
17"	CSB-15L	CSB-15R

DOUBLE FACE

OVERALL SUPPORT DEPTH	CATALOG NO.*
14"	CDB-6
16"	CDB-7
18"	CDB-8
20"	CDB-9
22"	CDB-10
24"	CDB-11
26"	CDB-12
32"	CDB-15



FRAMES AND SUPPORTS *(Continued)*

GUSSETED BASE SUPPORTS



For use in seismic and/or mobile shelving applications. Specify Single Face Base Supports left or right.

SINGLE FACE

OVERALL SUPPORT DEPTH	LEFT END CATALOG NO.*	RIGHT END CATALOG NO.*
8"	CSBG-6L	CSBG-6R
9"	CSBG-7L	CSBG-7R
10"	CSBG-8L	CSBG-8R
11"	CSBG-9L	CSBG-9R
12"	CSBG-10L	CSBG-10R
13"	CSBG-11L	CSBG-11R
14"	CSBG-12L	CSBG-12R
17"	CSBG-15L	CSBG-15R

DOUBLE FACE

OVERALL SUPPORT DEPTH	CATALOG NO.*
14"	CDBG-6
16"	CDBG-7
18"	CDBG-8
20"	CDBG-9
22"	CDBG-10
24"	CDBG-11
26"	CDBG-12
32"	CDBG-15

NOTE:

- * Catalog number corresponds to actual depth of Base Shelf used.
- Gusseted Base Supports are 69" high.

TRANSVERSE OVERHEAD TIE STRUTS



For extra stabilization overhead when local conditions require.

STRUT LENGTH	CATALOG NO.
96"	CTTS-96
120"	CTTS-120
WALL ANCHOR BRACKET*	CTSWA
SPLICE KIT*	CTTS-SK

NOTE:

- * Includes hardware.

WALL COLUMN SUPPORTS



All shelves and accessory components can easily be attached to Wall Column Supports for wall-mounted installations. Column width and depth: 2³/₄" wide x 3³/₄" deep.*

COLUMN HEIGHT	CATALOG NO.
42"	CWFC-42
66"	CWFC-66
78"	CWFC-78
84"	CWFC-84
90"	CWFC-90

NOTE:

- * If Canopy Tops are desired for use with Wall Column Supports, consult factory.
- Special heights available.
- Recommended for concrete or brick walls. To be anchored with the appropriate hardware supplied by the installer for the specific wall material.

BASE SHELVES

3" BASE SHELVES*



3" Base Shelves position media clear of brooms and floor mops.

ACTUAL SHELF DEPTH	CATALOG NO.
6"	CBSPB-3606
7"	CBSPB-3607
8"	CBSPB-3608
9"	CBSPB-3609
10"	CBSPB-3610
11"	CBSPB-3611
12"	CBSPB-3612
15"	CBSPB-3615

3" SLOPED PLAIN BASE SHELVES*



Sloped to aid viewing of items on the bottom shelf.

ACTUAL SHELF DEPTH	CATALOG NO.
6"	CBSPB-3606SL
7"	CBSPB-3607SL
8"	CBSPB-3608SL
9"	CBSPB-3609SL
10"	CBSPB-3610SL
11"	CBSPB-3611SL
12"	CBSPB-3612SL
15"	CBSPB-3615SL

NOTE: * If End Panels are used with Sloped Base Shelf, consult factory for End Panel dimension.

3" BASE SHELVES WITH INTEGRAL LOW-BACK*



Integral Low-Back Shelves are compatible with Integral Low-Back Dividers.

ACTUAL SHELF DEPTH	CATALOG NO.
6"	CLBBSB-3606
7"	CLBBSB-3607
8"	CLBBSB-3608
9"	CLBBSB-3609
10"	CLBBSB-3610
11"	CLBBSB-3611
12"	CLBBSB-3612
15"	CLBBSB-3615

NOTE: * Integral Low-Back Dividers (Catalog No. CLBDxx) sold separately. See page 16 for corresponding Integral Low-Back Dividers.

3" SLOPED BASE SHELVES WITH INTEGRAL LOW-BACK*



Sloped to aid viewing of items on the bottom shelf. Integral Low-Back Shelves are compatible with Integral Low-Back Dividers.

ACTUAL SHELF DEPTH	CATALOG NO.
6"	CLBBSB-3606SL
7"	CLBBSB-3607SL
8"	CLBBSB-3608SL
9"	CLBBSB-3609SL
10"	CLBBSB-3610SL
11"	CLBBSB-3611SL
12"	CLBBSB-3612SL
15"	CLBBSB-3615SL

NOTE: * Integral Low-Back Dividers (Catalog No. CLBDxx) sold separately. See page 16 for corresponding Integral Low-Back Dividers.
* If End Panels are used with Sloped Base Shelf, consult factory for End Panel dimension.

3" SLOTTED BASE SHELVES*



Slotted on 1" centers for Dividers. Includes Slotted Backstop.

ACTUAL SHELF DEPTH	CATALOG NO.
6"	CBSSB-3606
7"	CBSSB-3607
8"	CBSSB-3608
9"	CBSSB-3609
10"	CBSSB-3610
11"	CBSSB-3611
12"	CBSSB-3612
15"	CBSSB-3615

NOTE: * Dividers sold separately. See page 15.

3" SLOPED SLOTTED BASE SHELVES*



Slotted on 1" centers for Dividers. Sloped to aid viewing of items on the bottom shelf. Includes Slotted Backstop.

ACTUAL SHELF DEPTH	CATALOG NO.
6"	CBSSB-3606SL
7"	CBSSB-3607SL
8"	CBSSB-3608SL
9"	CBSSB-3609SL
10"	CBSSB-3610SL
11"	CBSSB-3611SL
12"	CBSSB-3612SL
15"	CBSSB-3615SL

NOTE: * Dividers sold separately. See page 15.
* If End Panels are used with Sloped Base Shelf, consult factory for End Panel dimension.

* Base Shelves include End Brackets. Standard widths of 36", 24" and 30" are available. Change the catalog number accordingly, e.g., CBSPB-2411. If 1" nominal "Base Shelves" are desired, see below for Adjustable Shelves.

ADJUSTABLE SHELVES

PLAIN ADJUSTABLE SHELVES*



All shelves include End Brackets.

ACTUAL SHELF DEPTH	CATALOG NO.
6"	CSPB-3606
7"	CSPB-3607
8"	CSPB-3608
9"	CSPB-3609
10"	CSPB-3610
11"	CSPB-3611
12"	CSPB-3612
15"	CSPB-3615

* 24" and 30" shelf widths are available.

ADJUSTABLE SHELVES WITH INTEGRAL LOW-BACK*



Integral Low-Back Shelves are compatible with Integral Low-Back Dividers

ACTUAL SHELF DEPTH	CATALOG NO.
6"	CLBSB-3606
7"	CLBSB-3607
8"	CLBSB-3608
9"	CLBSB-3609
10"	CLBSB-3610
11"	CLBSB-3611
12"	CLBSB-3612
15"	CLBSB-3615

NOTE: * Integral Low-Back Dividers (Catalog No. CLBDxx) sold separately. See page 16 for corresponding Integral Low-Back Dividers.

ADJUSTABLE SHELVES *(Continued)*

SLOTTED ADJUSTABLE SHELVES*



Slotted on 1" centers for Dividers. Includes Slotted Backstop.

ACTUAL SHELF DEPTH	CATALOG NO.
6"	CSSB-3606
7"	CSSB-3607
8"	CSSB-3608
9"	CSSB-3609
10"	CSSB-3610
11"	CSSB-3611
12"	CSSB-3612
15"	CSSB-3615

NOTE: • Dividers sold separately. For Dividers, see page 15.

SLOPED ADJUSTABLE SHELVES WITH INTEGRAL LOW BACK*



Sloped to aid viewing of displayed items. Integral Low-Back Shelves are compatible with Integral Low-Back Dividers.

ACTUAL SHELF DEPTH	CATALOG NO.
6"	CLBSB-3606SL
7"	CLBSB-3607SL
8"	CLBSB-3608SL
9"	CLBSB-3609SL
10"	CLBSB-3610SL
11"	CLBSB-3611SL
12"	CLBSB-3612SL
15"	CLBSB-3615SL

NOTE: • Integral Low-Back Dividers (Catalog No. CLBDxx) sold separately. See page 16 for corresponding Integral Low-Back Divider.
• If End Panels are used with Sloped Base Shelf, consult factory for End Panel dimension.

SLOPED PLAIN ADJUSTABLE SHELVES*



Sloped for easier viewing of displayed items.

ACTUAL SHELF DEPTH	CATALOG NO.
6"	CSPB-3606SL
7"	CSPB-3607SL
8"	CSPB-3608SL
9"	CSPB-3609SL
10"	CSPB-3610SL
11"	CSPB-3611SL
12"	CSPB-3612SL
15"	CSPB-3615SL

NOTE: • If End Panels are used with Sloped Shelf, consult factory for End Panel dimension.

SLOPED SLOTTED ADJUSTABLE SHELVES*



Sloped to aid viewing of displayed items. Includes Slotted Backstop.

ACTUAL SHELF DEPTH	CATALOG NO.
6"	CSSB-3606SL
7"	CSSB-3607SL
8"	CSSB-3608SL
9"	CSSB-3609SL
10"	CSSB-3610SL
11"	CSSB-3611SL
12"	CSSB-3612SL
15"	CSSB-3615SL

NOTE: • Dividers sold separately. For Dividers, see page 15.
• If End Panels are used with Sloped Base Shelf, consult factory for End Panel dimension.

* Shelves include End Brackets. 24" and 30" shelf widths are available. Change the catalog number accordingly. e.g., CSPB-2410 Adjustable Shelves may be used as Base Shelves in conjunction with the Adjustable Kick Plates.

SPECIALTY SHELVES

PERIODICAL DISPLAY SHELF (HINGED)



Sloped display surface (with no exposed fasteners) is 14" high. Flat storage shelf is 12" deep.

ACTUAL SHELF DEPTH/DISPLAY	CATALOG NO.
12"/14"	CHPD3612
12"/14" (SPECIAL 3" BASE)	CHPD3612

NOTE: • The vertical opening between the flat shelf and the hinged display shelf (in the open position) is 6" clear.
• Recommend minimum 14" vertical center-to-center spacing.
• Front retaining lip is 1" deep.

FIXED DISPLAY SHELF



11" high, sloped display surface for merchandising of books, tapes and periodicals.

ACTUAL SHELF DEPTH	FRONT LIP SIZE	CATALOG NO.
11"	1"	CFPS1-3611
11"	2"	CFPS2-3611
11"	3"	CFPS3-3611

NOTE: • Recommend minimum 11" vertical center-to-center spacing.

PERIODICAL DISPLAY SHELF (HINGED) WITH PLEXIGLAS COVERS



Sloped display is 14" high. Flat storage shelf is 12" deep.

ACTUAL SHELF DEPTH/DISPLAY	CATALOG NO.
12"/14"	CHPSC-3612
12"/14" (SPECIAL 3" BASE)	CHPSC3-3612

NOTE: • The vertical opening between the flat shelf and the hinged display shelf (in the open position) is 6" clear.
• Recommend minimum 14" vertical center-to-center spacing.
• Front retaining lip is 1" deep.

FLAT STORAGE SHELF



Includes End Brackets. Can be used for storage under the Fixed Display Shelf.

ACTUAL SHELF DEPTH	CATALOG NO.
11"	CFSSB3611
12"	CFSSB3612
15"	CFSSB3615

SPECIALTY SHELVES *(Continued)*

PULL-OUT REFERENCE SHELF



For convenient referencing, Pull-Out Reference Shelf has a 50 lb. load capacity.

ACTUAL REFERENCE SHELF WIDTH/DEPTH	TO BE USED WITH SHELF DEPTH	CATALOG NO.
32"/9"	8"	CSRS-3609-08
32"/9"	9"	CSRS-3609-09
32"/11"	10"	CSRS-3611-10
32"/11"	11"	CSRS-3611-11
32"/11"	12"	CSRS-3611-12
32"/11"	15"	CSRS-3611-15

NOTE:

- Requires minimum 1" clear space underneath stationary shelf.
- Order Shelf separately.

2 TIER MICROFILM SHELF



Each 36" wide shelf holds approximately 40 - 1 1/4" w. x 4" d. x 4" h. microfilm boxes (20 per tier).

ACTUAL SHELF DEPTH	OVERALL SHELF HEIGHT	CATALOG NO.
9"	7"	CMSS-3609 (Adjustable)
9"	10"	CMSSB-3609 (Base)

NOTE:

- Recommend a minimum 10" vertical center-to-center spacing.

VHS, CD & PAPERBACK SHELF



Slotted on 1" centers. Includes one (1) Slotted Backstop and four (4) Dividers per shelf. Each shelf holds approximately 26 VHS tapes or 80 CDs.

ACTUAL SHELF DEPTH	CATALOG NO.
6"	CPV-3606

NOTE:

- When storing standard VHS tapes upright, recommend a minimum 10" vertical center-to-center spacing.

MULTIMEDIA BROWSING BOX



Each 36" wide unit stores approximately 42 VHS tapes or 100 CDs. Shown here accepting Snap-In Wire Dividers, catalog no. CHWS-67.

DEPTH	HEIGHT	CATALOG NO.
12"	6 1/4"	CBBM3612

NOTE:

- Includes black, non-skid floor mat.
- CHWS-67 "Snap-In" Wire Dividers sold separately. See page 16.
- When storing standard VHS tapes, recommend a minimum of 10" vertical center-to-center spacing.

2 TIER, SLOPED VHS & CD SHELF



Each 36" wide shelf holds approximately 56 VHS tapes (28 per tier) or 168 CDs (84 per tier). Sloped to aid viewing.

OVERALL SHELF DEPTH	ACTUAL END BRACKET HEIGHT	CATALOG NO.
14"	11"	CVCD3615DT

NOTE:

- When storing standard VHS tapes on the second tier, recommend a minimum of 17" vertical center-to-center spacing.
- Also in 24" and 30" widths. Change the catalog no. accordingly, e.g. CVCD2415DT.

1 TIER MULTIMEDIA BROWSING BOX (DIVIDER-TYPE)



2 TIER MULTIMEDIA BROWSING BOX (DIVIDER-TYPE)



DEPTH	HEIGHT	CATALOG NO.
12"	6 1/4"	CBB3612SMM

NOTE:

- Includes one black, non-skid floor mat.
- Dividers sold separately. See below for CMMD955 Dividers.
- When storing standard VHS tapes, recommend a minimum 10" vertical center-to-center spacing.

DEPTH	HEIGHT	CATALOG NO.
15"	8 1/2"	CBB3615SMMDT

NOTE:

- Includes two black, non-skid floor mats.
- Dividers sold separately. See below for CMMD568 Dividers.
- When storing standard VHS tapes, recommend a minimum 12" vertical center-to-center spacing.

VHS & CD WIRE RACK

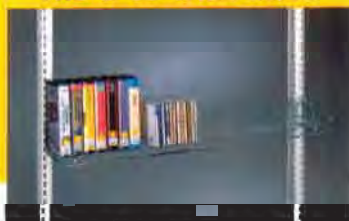

One VHS & CD Wire Rack holds 26 VHS tapes or 78 CDs.

ACTUAL RACK DEPTH	CATALOG NO.
6"	CVHSCD-R-36

NOTE:

- When storing standard VHS tapes, recommend a minimum of 10" vertical center-to-center spacing.

MULTIMEDIA BROWSING BOX DIVIDERS

FOR BROWSING BOX TYPE

FOR BROWSING BOX TYPE	CATALOG NO.
1 TIER (CBB3612SMM)	CMMD955
2 TIER (CBB3615SMMDT)	CMMD568

MEDIA

MEDIA	QUANTITY OF DIVIDERS PER TIER
CDs	5
VHS TAPES	5
MICROFILM BOXES	7
AUDIO CASSETTE TAPES	11

2 TIER AUDIO CASSETTE TAPE SHELF



Each 36" wide shelf holds approximately 100 audio cassette tapes (50 per tier).

ACTUAL SHELF DEPTH	OVERALL SHELF HEIGHT	CATALOG NO.
6"	7"	CATASB-3606 (Adjustable)
6"	10"	CATBSB-3606 (Base)

NOTE:

- Recommend a minimum 11" vertical center-to-center spacing.
- Also in 24" and 30" widths. Change the catalog no. accordingly, e.g. CATASB-3006.

ACCESSORIES

ZIGZAG DISPLAY BACKSTOP



For merchandising a variety of audio-visual and paperback media.

HEIGHT	CATALOG NO.
3 3/4"	CZBS-36

NOTE: • Includes Backstop and fasteners only. Order Shelf separately.

CENTERSTOP* (Offset for back-to-back shelving)



Eliminates the need for individual backstops.

HEIGHT	CATALOG NO.
3 3/4"	CCS-36

NOTE: • Order Shelves separately.

PLAIN BACKSTOP* (Narrow)



Order one (1) per shelf.

HEIGHT	CATALOG NO.
3 3/4"	CABP36

NOTE: • Order Shelf separately.

SLOTTED BACKSTOP* (Narrow)



Order one (1) per shelf.

HEIGHT	CATALOG NO.
3 3/4"	CABS36

NOTE: • Order Shelf separately.

PLAIN BACKSTOP* (Full height)



Interlocks with shelf. Order one (1) per shelf.

HEIGHT	CATALOG NO.
6"	CPBS-36

SLOTTED BACKSTOP* (Full height)



Interlocks with shelf. Order one (1) per shelf.

*24" and 30" widths available.

HEIGHT	CATALOG NO.
6"	CSBS-36

DIVIDERS



Dividers are all 6" high.

ACTUAL SHELF DEPTH	CATALOG NO.
6"	CFD-6
7"	CFD-7
8"	CFD-8
9"	CFD-9
10"	CFD-10
11"	CFD-11
12"	CFD-12
15"	CFD-15

6 TIER NEWSPAPER RACK

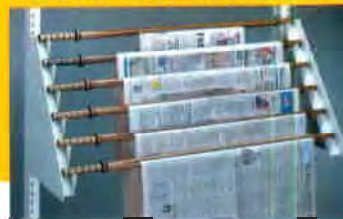

Display up to 6 newspapers.

CATALOG NO.
CNR615

NOTE: • For 36" newspaper sticks. Newspaper sticks not included.

MEDIA BAG RACK



Hang large or small media bags on this 36" rod. Includes deflection inhibiting low-back shelf, clip and end brackets.

WILL ACCOMMODATE MEDIA BAGS UP TO...	ACTUAL END BRACKET DEPTH	SHELF DEPTH	CATALOG NO.
12" deep	10"	6"	CMHR3610
20" deep	12"	10"	CMHR3612

NOTE: • Media bags not included.

STEEL BOOK SUPPORTS



A. FINDABLE BOOK SUPPORT
Eliminates searching for book supports between books.

HEIGHT	PAD TYPE	CATALOG NO.
6"	With full cork base	CBE-06NL
9"	With full cork base	CBE-09NL
10"	With full cork base	CBE-10NL
6"	With magnetic base	CBE-06NLM
9"	With magnetic base	CBE-09NLM
10"	With magnetic base	CBE-10NLM

B. FLAT BOOK END
Place media on top of the Flat Book End for support.

HEIGHT	CATALOG NO.
4"	CACD-4
6"	CBE-06
9"	CBE-09

NOTE: • Includes full cork base.

C. CLIP ON BOOK SUPPORT
Easy to locate the "Clip-On" Book Support since it clips on the shelf front.

HEIGHT	CATALOG NO.
6"	CCOD6
9"	CCOD9

NOTE: • Includes full cork base.

ACCESSORIES (Continued)

"W" HANGING WIRE SUPPORT (Squeeze Type)



Available in three (3) sizes for five (5) different shelf depths.

ACTUAL SHELF DEPTH	CATALOG NO.
8" & 9"	CWWS08
10" & 11"	CWWS10
12"	CWWS12

NOTE: • If used with Canopy Tops, order "W" Type Canopy Tops.

"SNAP IN" HANGING WIRE BOOK SUPPORT



The "Snap In" Hanging Wire Book Supports come in four (4) different sizes.

ACTUAL SHELF DEPTH	CATALOG NO.
6" & 7"	CHWS-67*
8" & 9"	CHWS-89
10", 11" & 12"	CHWS-1012
15"	CHWS-15

NOTE: * CHWS-67 also works with Multimedia Browsing Box, catalog no. CBBM3612.

CANOPY TOP*



Includes mounting brackets.

SINGLE FACE

OVERALL TOP DEPTH	ACTUAL SHELF DEPTH	CATALOG NO.
8"	6"	CCTSB-3606
9"	7"	CCTSB-3607
10"	8"	CCTSB-3608
11"	9"	CCTSB-3609
12"	10"	CCTSB-3610
13"	11"	CCTSB-3611
14"	12"	CCTSB-3612
17"	15"	CCTSB-3615

DOUBLE FACE

OVERALL TOP DEPTH	ACTUAL SHELF DEPTH	CATALOG NO.
14"	6"	CCTDB-3606
16"	7"	CCTDB-3607
18"	8"	CCTDB-3608
20"	9"	CCTDB-3609
22"	10"	CCTDB-3610
24"	11"	CCTDB-3611
26"	12"	CCTDB-3612
32"	15"	CCTDB-3615

NOTE: • Not compatible with "W" Hanging Wire Dividers. When "W" Hanging Wire Dividers are used, change "-" to "W" for a Canopy Top which will accommodate "W" Hanging Wire Dividers, e.g., CCTDBW3609.

INTEGRAL LOW-BACK DIVIDERS (For Integral Low-Back Shelves)



Available in three (3) sizes for five (5) different shelf depths.

ACTUAL SHELF DEPTH	CATALOG NO.
8" & 9"	CLBD08
10", & 11"	CLBD10
12"	CLBD12

NOTE: • Order Integral Low-Back Shelf separately.

CANOPY LIGHT



Illuminate display shelves or brighten dimly lit alcoves. Includes white prismatic diffuser.

WIDTH	DEPTH	CATALOG NO.
36"	20 1/2"	CCLIGHT3621

NOTE: • Internal, UL listed 24" light fixture accepts 2-24" long bulbs.
• Bulbs not included.
• Light housing is 12 3/8" deep and 5" high.

RANGE FINDER & CARD HOLDERS



TYPE	SIZE	CATALOG NO.
A. Range Finder	3"H x 5"D	RFST35
B. Continuous Card Holder	4"H	CSIHwww
(Where "www" is the actual End Panel width, e.g. Use CSIH20 for a 20" wide End Panel.)		
C. 3x5 Card Holder	3"H x 5"D	CHST35

NOTE: • A & B available in the color to match the color of shelving ordered.
• C available in black finish.
• B & C include double-back tape.

BRACKETS FOR LAMINATED CANOPY TOP



Fasteners included.

ACTUAL OVERALL TOP DEPTH	LEFT END CATALOG NO.	RIGHT END CATALOG NO.
6", 7" & 8"	CCTBL-6L	CCTBL-6R
9", 10", 11", 12" & 15"	CCTBL-15L	CCTBL-15R

NOTE: • Order left and right brackets separately. In the above photo, one CCTBL-15L and one CCTBL-15R are shown in conjunction with a 20" deep (overall) laminated canopy top which was designed to accommodate actual 3" deep shelves.

SHELF LABEL HOLDERS



TYPE	WIDTH	CATALOG NO.
A. Clear Plastic Label Holder	5"	CLH-05
B. Magnetic Label Holder	36"	LH-36

NOTE: • Both A & B include paper label inserts.

BASE SHELF FILLER*



Fills the space between the two back-to-back Base Shelves.

SHELF WIDTH	CATALOG NO.
36" (For use with 3" Base Shelf.)	CBSF-36
36" (For use with 1" Base Shelf.)	CBSF1-36

*24" and 30" widths available.

ACCESSORIES (Continued)

ADJUSTABLE SHELF FILLER*



Fills the space between two back-to-back Adjustable Shelves.

SHELF WIDTH	CATALOG NO.
36"	CASF36

ADJUSTABLE KICK PLATES*



Adjustable Kick Plates may be used when Adjustable Shelves are used as Base Shelves.

KICK PLATE TYPE	CATALOG NO.
RECESSED**	CKP36
FLUSH (Not Shown)	CFKP36

NOTE:

- Adjustable, Flush Kick Plate not shown.
- ** Base supports must be 1" less than shelf depth when using Adjustable Recessed Kick Plate.
- Both types include mounting hardware.
- Both may be used with or without levelers.

*24" and 30" widths available.

LEVELER KITS



Use when floor is out of level.

SINGLE FACE

NO. OF LEVELING FEET PER KIT	ACTUAL BASE SUPPORT DEPTHS	CATALOG NO.
3	8", 9" & 10"	CSFL0608
4	11", 12", 13", 14" & 17"	CSFL0915

DOUBLE FACE

NO. OF LEVELING FEET PER KIT	ACTUAL BASE SUPPORT DEPTHS	CATALOG NO.
4	14", 16" & 18"	CDFL0608
6	20", 22", 24", 26" & 32"	CDFL0915

NOTE: • Order one (1) kit per base support.

WALL ATTACHMENT BRACKET



For attaching single face Welded Frames to a wall.

CATALOG NO.

CWAB

NOTE: • Fastening hardware not included since wall material may vary.

OPTIONS

INTERMEDIATE WALL FILLERS



Fills the rectangular void created when two single face sections are placed at a right angle with a double face section. Specify overall unit depths (ds & dd) and frame height used (ht).

CATALOG NO.

CIF-dsdddsh

NOTE:

- ds = overall depth of the single face unit in inches (including the 2" frame)
- dd = overall depth of the double face unit in inches (including the 2" frame)
- ht = height of the adjoining Welded Frame, e.g., CIF-11201184 (for shelves with an actual depth of 9").

CORNER FILLERS



Fills the corner void created when single face sections are placed at right angles. Specify overall unit depths (dsds) and frame height used (ht).

CATALOG NO.

CCF-dsdsht

NOTE:

- ds = overall depth of the single face unit in inches (including the 2" frame)
- ht = height of the adjoining Welded Frame, e.g., CCF-111184 (for shelves with an actual depth of 9").

OPTIONS *(Continued)*

END PANEL MOUNTING BRACKETS



For use on both Metal End Panels and Laminate End Panels when Canopy Top is not used. Double face bracket shown.

SINGLE FACE

ACTUAL SHELF DEPTH	CATALOG NO.
6"	CMEPSS08L
6"	CMEPSS08R
7"	CMEPSS09L
7"	CMEPSS09R
8"	CMEPSS10L
8"	CMEPSS10R
9"	CMEPSS11L
9"	CMEPSS11R
10"	CMEPSS12L
10"	CMEPSS12R
11"	CMEPSS13L
11"	CMEPSS13R
12"	CMEPSS14L
12"	CMEPSS14R
15"	CMEPSS17L
15"	CMEPSS17R

DOUBLE FACE

ACTUAL SHELF DEPTH	CATALOG NO.
6"	CMEPSD14
7"	CMEPSD16
8"	CMEPSD18
9"	CMEPSD20
10"	CMEPSD22
11"	CMEPSD24
12"	CMEPSD26
15"	CMEPSD32

NOTE: • Order one (1) per End Panel.

CLOSED BACK KITS



Fills the space between the upright frame. Kits include two (2) Upright Fillers (hidden from view).

FRAME HEIGHT	CATALOG NO.
42"	CBPF-4236
66"	CBPF-6636
78"	CBPF-7836
84"	CBPF-8436
90"	CBPF-9036

NOTE: • Also available in 24" and 30" widths. Change the catalog no. accordingly, e.g.: CBPF-4224.

CLOSURE PANELS



May be used to enclose backside of the End Panels. Match the End Panel size.

END PANEL WIDTH		CATALOG NO.
78" FRAME HEIGHT		
8"	SINGLE FACE	CCP-0878
9"	SINGLE FACE	CCP-0978
10"	SINGLE FACE	CCP-1078
11"	SINGLE FACE	CCP-1178
12"	SINGLE FACE	CCP-1278
13"	SINGLE FACE	CCP-1378
14"	SINGLE FACE	CCP-1478S
17"	SINGLE FACE	CCP-1778
14"	DOUBLE FACE	CCP-1478D
16"	DOUBLE FACE	CCP-1678
18"	DOUBLE FACE	CCP-1878
20"	DOUBLE FACE	CCP-2078
22"	DOUBLE FACE	CCP-2278
24"	DOUBLE FACE	CCP-2478
26"	DOUBLE FACE	CCP-2678
32"	DOUBLE FACE	CCP-3278

84" FRAME HEIGHT

8"	SINGLE FACE	CCP-0884
9"	SINGLE FACE	CCP-0984
10"	SINGLE FACE	CCP-1084
11"	SINGLE FACE	CCP-1184
12"	SINGLE FACE	CCP-1284
13"	SINGLE FACE	CCP-1384
14"	SINGLE FACE	CCP-1484S
17"	SINGLE FACE	CCP-1784
14"	DOUBLE FACE	CCP-1484D
16"	DOUBLE FACE	CCP-1684
18"	DOUBLE FACE	CCP-1884
20"	DOUBLE FACE	CCP-2084
22"	DOUBLE FACE	CCP-2284
24"	DOUBLE FACE	CCP-2484
26"	DOUBLE FACE	CCP-2684
32"	DOUBLE FACE	CCP-3284

90" FRAME HEIGHT

8"	SINGLE FACE	CCP-0890
9"	SINGLE FACE	CCP-0990
10"	SINGLE FACE	CCP-1090
11"	SINGLE FACE	CCP-1190
12"	SINGLE FACE	CCP-1290
13"	SINGLE FACE	CCP-1390
14"	SINGLE FACE	CCP-1490S
17"	SINGLE FACE	CCP-1790
14"	DOUBLE FACE	CCP-1490D
16"	DOUBLE FACE	CCP-1690
18"	DOUBLE FACE	CCP-1890
20"	DOUBLE FACE	CCP-2090
22"	DOUBLE FACE	CCP-2290
24"	DOUBLE FACE	CCP-2490
26"	DOUBLE FACE	CCP-2690
32"	DOUBLE FACE	CCP-3290

OPTIONS *(Continued)*

METAL END PANELS

SINGLE FACE

ACTUAL SHELF DEPTH	CATALOG NO.
42" UPRIGHT HEIGHT	
6"	CRMEP4208
7"	CRMEP4209
8"	CRMEP4210
9"	CRMEP4211
10"	CRMEP4212
11"	CRMEP4213
12"	CRMEP4214
15"	CRMEP4217
66" UPRIGHT HEIGHT	
6"	CRMEP6608
7"	CRMEP6609
8"	CRMEP6610
9"	CRMEP6611
10"	CRMEP6612
11"	CRMEP6613
12"	CRMEP6614
15"	CRMEP6617
78" UPRIGHT HEIGHT	
6"	CRMEP7808
7"	CRMEP7809
8"	CRMEP7810
9"	CRMEP7811
10"	CRMEP7812
11"	CRMEP7813
12"	CRMEP7814
15"	CRMEP7817
84" UPRIGHT HEIGHT	
6"	CRMEP8408
7"	CRMEP8409
8"	CRMEP8410
9"	CRMEP8411
10"	CRMEP8412
11"	CRMEP8413
12"	CRMEP8414
15"	CRMEP8417
90" UPRIGHT HEIGHT	
6"	CRMEP9008
7"	CRMEP9009
8"	CRMEP9010
9"	CRMEP9011
10"	CRMEP9012
11"	CRMEP9013
12"	CRMEP9014
15"	CRMEP9017

DOUBLE FACE

ACTUAL SHELF DEPTH	CATALOG NO.
42" UPRIGHT HEIGHT	
6"	CRMEP4214D
7"	CRMEP4216D
8"	CRMEP4218D
9"	CRMEP4220D
10"	CRMEP4222D
11"	CRMEP4224D
12"	CRMEP4226D
15"	CRMEP4232D
66" UPRIGHT HEIGHT	
6"	CRMEP6614D
7"	CRMEP6616D
8"	CRMEP6618D
9"	CRMEP6620D
10"	CRMEP6622D
11"	CRMEP6624D
12"	CRMEP6626D
15"	CRMEP6632D
78" UPRIGHT HEIGHT	
6"	CRMEP7814D
7"	CRMEP7816D
8"	CRMEP7818D
9"	CRMEP7820D
10"	CRMEP7822D
11"	CRMEP7824D
12"	CRMEP7826D
15"	CRMEP7832D
84" UPRIGHT HEIGHT	
6"	CRMEP8414D
7"	CRMEP8416D
8"	CRMEP8418D
9"	CRMEP8420D
10"	CRMEP8422D
11"	CRMEP8424D
12"	CRMEP8426D
15"	CRMEP8432D
90" UPRIGHT HEIGHT	
6"	CRMEP9014D
7"	CRMEP9016D
8"	CRMEP9018D
9"	CRMEP9020D
10"	CRMEP9022D
11"	CRMEP9024D
12"	CRMEP9026D
15"	CRMEP9032D



Use to finish off the exposed ends of shelving ranges. Metal End Panels are 1-1/2" thick.

NOTE:

- End Panels should be sized to cover the overall base depth. (overall base shelf depth = actual shelf depth + 2" frame.)
- End Panel Mounting Brackets sold separately. See page 19.

www.southwestsolutions.com

Toll Free 1-800-803-1083



SOUTHWEST**SOLUTIONS**GROUP
business organization systems

