

SOUTHWEST SOLUTIONS GROUP  
business organization systems

THE LEADING EDGE IN MODULAR ERGONOMICS

ALL MODELS ON THE COVER SHIP IN 5 DAYS OR LESS!



THE "MODEL HD"



ERGO-LINE

Quality Ergonomics at a Price Any Company Can Afford. Professional Independent Workstations. ESD, Clean Room or to Your Own Design. **BEST VALUE! IN STOCK**

"State-of-the-Art" Ergonomic Hand Crank Vertical and/or Tilt Adjust. Reduce Repetitive Motion Stress and Increase Productivity. "The Workstation for the next century" **IN STOCK**



THE BASICS  
NEW TO THE **IN STOCK** PROGRAM

The Basics Workbench  
Incorporates an open frame concept  
Available single and double sided. **IN STOCK**



DIMENSION NEXT

MODULAR TECHNICAL SYSTEMS  
Free Standing and Add on Units  
Single and Double Sided. **IN STOCK**



Model MVSII

MVSII In Stock in Light Blue

**IN STOCK**

Frame  
In Stock Colors:  
Light Blue, Light Gray and Light Beige  
Work Surface: White  
with Black  
"T" Mold Edges  
HD, CHD, EL

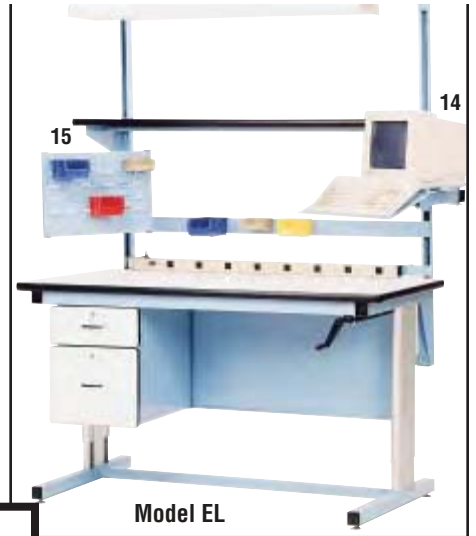

Model EL

Beige, Blue, Gray



The BASICS

See page 17 for details

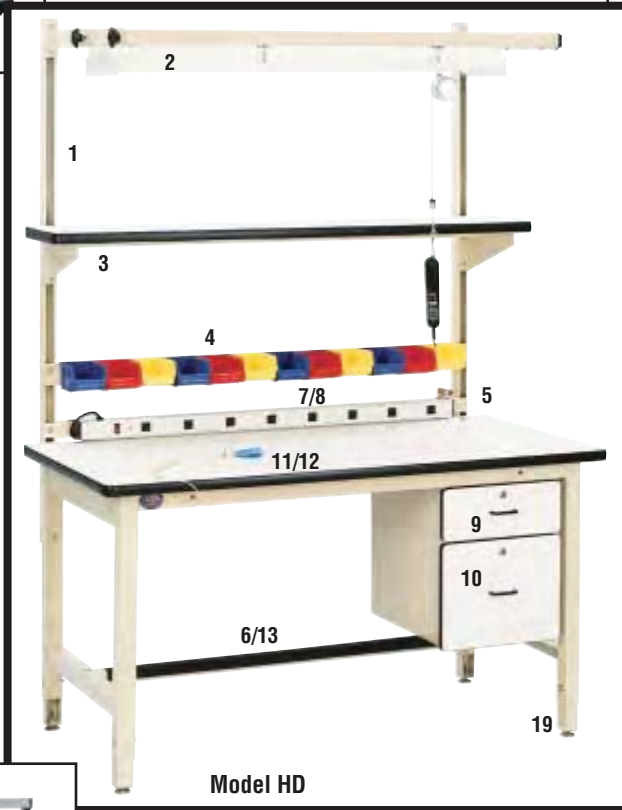

Model HD

Beige, Blue, Gray



Model CHD

Beige, Blue, Gray



Model CPB

CPB Light Gray Only



Model HD with Riser Shelf

Risers and Padlock Drawer In Stock in Light Blue

Pro-Line in stock products ship in 5 business days or less.  
 Pro-Line guarantees 10 pieces per model and color will be in stock.  
 For quantities larger than 10 call factory for availability.

**Light Blue Only (Model MVSII)**  
**Light Blue Only (Risers and Riser Options/DP-1)**

**Base Models**

Model HD 60" L x 30" W x 30" H		
STOCK NO.	TOP	Wgt. (lbs)
HD6030P	Plastic	115
HD6030C	Conductive	115
HD6030M	Maple	124
Model HD 60" L x 36" W x 30" H		
STOCK NO.	TOP	Wgt. (lbs)
HD6036P	Plastic	125
HD6036C	Conductive	125
HD6036M	Maple	162
Model CHD 60" L x 30" W x 30" H		
STOCK NO.	TOP	Wgt. (lbs)
CHD6030P	Plastic	138
CHD6030C	Conductive	138
CHD6030M	Maple	168
Model Ergoline 60" L x 30" W x 30" H to 42" H		
STOCK NO.	TOP	Wgt. (lbs)
EL6030P	Plastic	140
EL6030C	Conductive	140
EL6030M	Maple	175
Model MVSII 60" L x 30" W (Light Blue Only)		
STOCK NO.	TOP	Wgt. (lbs)
MVSII6030P	Plastic	210
MVSII6030C	Conductive	210
MVSII6030M	Maple	240

**Configure the work station to meet your requirements.**  
 When ordering please specify base model, (HD6030). Work surface choice: (P) standard laminate (ESD) ESD laminate (M) maple. Select options from graph below. Keep in mind some components mount to other components. ie: (OLF) light frame mounts to (UR60) uprights. Please specify frame color. Light Beige, Light Blue or Light Gray. Packaging Station available in Light Gray.

Model HD 72" L x 30" W x 30" H		
STOCK NO.	TOP	Wgt. (lbs)
HD7230P	Plastic	130
HD7230C	Conductive	130
HD7230M	Maple	145
Model HD 72" L x 36" W x 30" H		
STOCK NO.	TOP	Wgt. (lbs)
HD7236P	Plastic	140
HD7236C	Conductive	140
HD7236M	Maple	184
Model CHD 72" L x 30" W x 30" H		
STOCK NO.	TOP	Wgt. (lbs)
CHD7230P	Plastic	158
CHD7230C	Conductive	158
CHD7230M	Maple	195
Model Ergoline 72" L x 30" W x 30" H to 42" H		
STOCK NO.	TOP	Wgt. (lbs)
EL7230P	Plastic	155
EL7230C	Conductive	155
EL7230M	Maple	192
Model MVSII 72" L x 30" W (Light Blue Only)		
STOCK NO.	TOP	Wgt. (lbs)
MVSII7230P	Plastic	230
MVSII7230C	Conductive	230
MVSII7230M	Maple	272

**Optional In Stock Modular Accessories For Quick Ship Stations**

No.	Description	For 60" L x 30" W		Optional In Stock Modular Accessories For Quick Ship Stations	For 72" L x 30" W	
		Stock #	Weight		Stock #	Weight
1	Accessory Upright Supports (one pair) Extend 48" above surface	UR60	20		UR60	20
2	Overhead Light Frame with 2 bulb fixture	OLF60	27		OLF72	28
3	12" Deep Cantilever Shelf	CSPL1260P	30		CSPL1272P	36
3A	12" Deep Cantilever Shelf ESD	CSPL1260C	30		CSPL1272C	36
3B	18" Deep Cantilever Shelf	CSPL1860P	35		CSPL1872P	40
3C	18" Deep Cantilever Shelf ESD	CSPL1860C	35		CSPL1872C	40
4	Bin Holder	BH60	6		BH72	7
5	Air Supply (mounts ESMR)	AQDC	1.5		AQDC	1.5
6	Footrest	FR60	7		FR72	8
7	Power Supply (12 outlets 15 amp 120 volt)	ES48	4.5		ES48	4.5
8	Electrical Supply Mounting Rail	ESMR60	6		ESMR72	7
9	6" Drawer includes lock (Steel housing with laminate drawer face)	MDS6	26		MDS6	26
10	12" Drawer includes lock (Steel housing with laminate drawer face)	MDS12	38		MDS12	38
	Drawer Hanging Kit (one per station required with drawers, POWS or DP-1)	HK	0.52		HK	0.52
11	Ground Kit for Conductive Stations includes two banana jacks	SGK-J2	0.5		SGK-J2	0.5
12	Wrist Strap (requires SGK-J2)	SGS-4	0.25		SGS-4	0.25
13	Footrest Guard	FRG60	0.5		FRG72	0.5
14	Articulating Monitor Arm	MA-1	19		MA-1	19
15	Articulating Bin Arm	ABH-1	19		ABH-1	19
16	Tool Suspension Frame II (mounts to OLF)	LTF60	13		LTF72	14
17	Tool Balancer (mounts to LTF)	TB-5	6		TB-5	6
18	Pull Out Writing Shelf	POWS	12		POWS	12
19	6" Leg Extenders (Model HD only) 6" adjustment	HDLE-6	8		HDLE-6	8
20	3 Diopter Inspection Light	MAG1	9	MAG1	9	
21	Inspection Light Mounting Bracket	LOMB	1	LOMB	1	
22	Pad Lock Drawer (Light Blue Only)	DP-1	13	DP-1	13	
<b>Optional In Stock Work Surfaces Up Charge</b>						
23	90 degree rolled front edge upcharge	PF	N/A		PF	N/A



# IN STOCK QUICK SHIP PROGRAM (CONTINUED) DIMENSION NEXT



## MODULAR TECHNICAL SYSTEMS

### 'DIMENSION NEXT' EXPANDABLE MODULAR WORK STATIONS

Top quality finish meets modular ergonomic function with a price that is still affordable.

(each row requires one starter unit)

Base Part NO./ Size	Plastic Laminate	ESD Laminate
<b>DN6030SS</b> 60"L x 30"W <b>Single Starter</b>	<b>DN6030SSPL</b> Wgt. (lbs) 198	<b>DN6030SSESD</b> Wgt. (lbs) 198
<b>DN7230SS</b> 72"L x 30"W <b>Single Starter</b>	<b>DN7230SSPL</b> Wgt. (lbs) 217	<b>DN7230SSESD</b> Wgt. (lbs) 217
<b>DN6030SA</b> 60"L x 30"W <b>Single Add-On</b>	<b>DN6030SAPL</b> Wgt. (lbs) 148	<b>DN6030SAESD</b> Wgt. (lbs) 148
<b>DN7230SA</b> 72"L x 30"W <b>Single Add-On</b>	<b>DN7230SAPL</b> Wgt. (lbs) 168	<b>DN7230SAESD</b> Wgt. (lbs) 168

**In Stock 60" & 72" Long**

Base Part NO./ Size	Plastic Laminate	ESD Laminate
<b>DN6030DS</b> 60"L x 30"W <b>Double Starter</b>	<b>DN6030DSPL</b> Wgt. (lbs) 307	<b>DN6030DSESD</b> Wgt. (lbs) 307
<b>DN7230DS</b> 72"L x 30"W <b>Double Starter</b>	<b>DN7230DSPL</b> Wgt. (lbs) 360	<b>DN7230DSESD</b> Wgt. (lbs) 360
<b>DN6030DA</b> 60"L x 30"W <b>Double Add-On</b>	<b>DN6030DAPL</b> Wgt. (lbs) 260	<b>DN6030DAESD</b> Wgt. (lbs) 260
<b>DN7230DA</b> 72"L x 30"W <b>Double Add-On</b>	<b>DN7230DAPL</b> Wgt. (lbs) 300	<b>DN7230DAESD</b> Wgt. (lbs) 300



**See Pages 14 and 15 to learn more**

PART NO.	DESCRIPTION	WGT. (LBS)
<b>DNFR60</b>	Height adjustable and pivoting <b>footrest pan</b> fits 60" long DN stations.	27
<b>DNFR72</b>	Height adjustable and pivoting <b>footrest pan</b> fits 72" long DN stations.	33
<b>DNES60</b>	<b>Power supply</b> with 8 outlets, lighted on/off switch, built in circuit breaker and 6' long cord. Fits 60" long DN stations.	16
<b>DNES72</b>	<b>Power supply</b> with 8 outlets, lighted on/off switch, built in circuit breaker and 6' long cord. Fits 72" long DN stations.	20
<b>DNBH60</b>	<b>Bin Holder</b> for a 60" long DN station.	13
<b>DNBH72</b>	<b>Bin Holder</b> for a 72" long DN station.	16
<b>DNCCUP</b>	<b>Corner Unit</b> for 30" deep model DN Standard Laminate	25
<b>DNCCUC</b>	<b>Corner Unit</b> for 30" deep model DN ESD Laminate	25

PART NO.	DESCRIPTION	WGT. (LBS)
<b>DNOLF60</b>	<b>Over head light fixture and frame.</b> Price includes dual bulb fixture with lighted on/off switch and a 9' long cord, for a 60" long DN station.	30
<b>DNOLF72</b>	<b>Over head light fixture and frame.</b> Price includes dual bulb fixture with lighted on/off switch and a 9' long cord, for a 72" long DN station.	32
<b>DNAMS1260</b>	<b>Adjustable metal shelf</b> 12" deep x 60" long.	34
<b>DNAMS1272</b>	<b>Adjustable metal shelf</b> 12" deep x 72" long.	40
<b>MDS6</b>	<b>Modular Drawer</b> 6" high x 15" wide x 19.25" long. Price includes lock. Features include roller bearing guide and white laminate drawer face with rounded corners.	26
<b>MDS12</b>	<b>Modular Drawer</b> 12" high x 15" wide x 19.25" long. Price includes lock. Features include roller bearing guide and white laminate drawer face with rounded corners.	38
<b>HK</b>	<b>Drawer Hanging Kit</b> (one required per station with drawers.)	1.15
<b>SGK-J2</b>	<b>Standard Ground Kit</b> with 2 banana jacks. (For ESD stations only.)	0.5

See Pages 17 and 18 to learn more on  
Single Sided

## The Basics

**IN STOCK COLORS**

- Frames are painted with a durable circuit blue powder coat. (Standard color for the Basics Model).
- Options are painted with a durable textured black powder coat.

BASE PART NO./SIZE	Plastic Laminate	ESD Laminate	IN STOCK	QS
<b>B6030SS</b> 60"L x 30"W <b>Single Starter</b>	<b>B6030SSPL</b> Wgt. (lbs) 140	<b>B6030SSESD</b> Wgt. (lbs) 140		
<b>B7230SS</b> 72"L x 30"W <b>Single Starter</b>	<b>B7230SSPL</b> Wgt. (lbs) 170	<b>B7230SSESD</b> Wgt. (lbs) 170	IN STOCK	QS
<b>B6030SA</b> 60"L x 30"W <b>Single Add On</b>	<b>B6030SAPL</b> Wgt. (lbs) 130	<b>B6030SAESD</b> Wgt. (lbs) 130		
<b>B7230SA</b> 72"L x 30"W <b>Single Add On</b>	<b>B7230SAPL</b> Wgt. (lbs) 160	<b>B7230SAESD</b> Wgt. (lbs) 160	IN STOCK	QS
<b>B6030DS</b> 60"L x 30"W <b>Double Starter</b>	<b>B6030DSPL</b> Wgt. (lbs) 269	<b>B6030DSESD</b> Wgt. (lbs) 269		
<b>B7230DS</b> 72"L x 30"W <b>Double Starter</b>	<b>B7230DSPL</b> Wgt. (lbs) 319	<b>B7230DSESD</b> Wgt. (lbs) 319	IN STOCK	QS
<b>B6030DA</b> 60"L x 30"W <b>Double Add On</b>	<b>B6030DAPL</b> Wgt. (lbs) 229	<b>B6030DAESD</b> Wgt. (lbs) 229		
<b>B7230DA</b> 72"L x 30"W <b>Double Add On</b>	<b>B7230DAPL</b> Wgt. (lbs) 279	<b>B7230DAESD</b> Wgt. (lbs) 279	IN STOCK	QS



Options unique to the Basics Station.

Single Sided stations come complete with frame, two top supports, two horizontal leg supports and one worksurface.

Double Sided stations come complete with frame, four top supports, four horizontal leg supports and two worksurfaces.

Add on stations share a top support and a horizontal leg.

The modular accessories shown with the Basics station are unique to this model

PART NO.	DESCRIPTION	Wgt. (lbs)
<b>BOLF60</b>	Over head dual bulb light and frame for 60" L Basics.	30
<b>BOLF72</b>	Over head dual bulb light and frame for 72" L Basics.	32
<b>BMCS1260</b>	Metal Cantilever Shelf 12"D x 60"L For 60" Basics.	27
<b>BMCS1272</b>	Metal Cantilever Shelf 12"D x 72"L For 72" Basics.	32
<b>BBH60</b>	Parts Bin Holder for a 60"L Basics.	13
<b>BBH72</b>	Parts Bin Holder for a 72"L Basics.	16



KEYBOARD TRAYS		
PART NO.	DESCRIPTION	WGT. (LBS)
<b>KBT</b>	Sliding Keyboard Tray with arm rest	6
<b>MP</b>	Mouse pad for the KBT	3
<b>PRO-18785</b>	Pull Out CPU Holder	9

## PULL OUT CPU HOLDER



## FSMA FLAT SCREEN MONITOR ARM\*

75mm or 100mm Hole to Hole Mounting.

PART NO.	DESCRIPTION	Wgt. (lbs)
<b>FSMA</b>	Flat Screen Monitor Arm	21
<b>FSMAKBT</b>	Adjustable Keyboard Tray	11

**\*MONITOR AND KEYBOARD NOT INCLUDED**



## IN STOCK CASTERS

Kits include a set of casters and hardware.  
Model HD kits include leg extensions.  
For models CHD, EL and MVSII the kits includes retrofit mounting bracket.  
These casters can be mounted to existing benches.  
NOTE: Adds 4.25" to overall height

PART NO.	DESCRIPTION	WGT. LBS	IN STOCK
<b>TLC-4/HDQS</b>	Caster and Mounting brackets for the HD	15.3	
<b>TLC-4/CHDQS</b>	Caster and Mounting brackets for the CHD	15	
<b>TLC-4/ELQS</b>	Caster and Mounting brackets for the EL	15	
<b>TLC-4/MVSQS</b>	Caster and Mounting brackets for the MVS	15	



# IN STOCK QUICK SHIP PROGRAM



## Model CPB 60" L x 30" W x 30" to 36" H

PART NO.	TOP	Wgt. (lbs)
CPB6030P	Plastic	325
CPB6030C	Conductive	325
CPB6030M	Maple	362

## Model CPB 72" L x 30" W x 30" to 36" H

PART NO.	TOP	Wgt. (lbs)
CPB7230P	Plastic	355
CPB7230C	Conductive	355
CPB7230M	Maple	399

## COMPLETE PACK BENCH

Pro-Line's packaging stations are sold complete with all accessories shown. Features include lower metal shelf with four dividers, full storage shelf with 4" clearance, UR72 uprights, bin holder, 6 outlet electric supply, paper spool holder, enclosed metal shelf 12" deep with four dividers, corrugated storage shelf with four 12" x 18" dividers, and shop light. ESD price includes ground kit.



Packaging Stations are available in Light Gray Frame Only.

See page 20 for more Pack Stations

## TECHNICIAN STATIONS

The **Model TSHD** comes complete as shown. Price includes base unit 30" or 36" deep and 60" or 72" long. (Work surface height adjusts from 30" to 36.), modular drawer 6" and 12" with laminate face, personal pad lock drawer with hanging kits, riser 12" deep x 18" high with 6 pre-wired outlets, and a 90° rolled front edge. ESD stations also include ESD work surface and ESD shelf surface and a standard ground kit with two banana jacks.

### THE MODEL TSHD

*One great station,*

*one great price,*

*one easy to order part number.*



Front brace of riser removed to show electrical outlets.

The model TSHD is in stock with white surfaces and light blue frames.

BASE PART NO./ SIZE	Plastic Laminate	ESD Laminate
<b>TSHD6030</b> 60"L x 30"W	<b>TSHD6030PL</b> Wgt (lbs) 254	<b>TSHD6030ESD</b> Wgt (lbs) 255
<b>TSHD7230</b> 72"L x 30"W	<b>TSHD7230PL</b> Wgt (lbs) 278	<b>TSHD7230ESD</b> Wgt (lbs) 278
<b>TSHD6036</b> 60"L x 36"W	<b>TSHD6036PL</b> Wgt (lbs) 264	<b>TSHD6036ESD</b> Wgt (lbs) 265
<b>TSHD7236</b> 72"L x 36"W	<b>TSHD7236PL</b> Wgt (lbs) 288	<b>TSHD7236ESD</b> Wgt (lbs) 288

### Riser without Electric

DESCRIPTION/SIZE	Plastic Laminate	ESD Laminate
60"Lx12"Wx18"H	<b>R6012-1PL</b>	<b>R6012-1ESD</b>
	Wgt (lbs) 41	Wgt (lbs) 41
72"x12"Wx18"H	<b>R7212-1PL</b>	<b>R7212-1ESD</b>
	Wgt (lbs) 48	Wgt. (lbs) 48

### Riser with 6 Electric Outlets (across rear)

DESCRIPTION/SIZE	Plastic Laminate	ESD Laminate
60"Lx12"Wx18"H	<b>R6012-3PL</b>	<b>R6012-3ESD</b>
	Wgt (lbs) 46	Wgt (lbs) 46
72"x12"Wx18"H	<b>R7212-3PL</b>	<b>R7212-3ESD</b>
	Wgt (lbs) 53	Wgt. (lbs) 53

See photograph inside front cover and pages 6, 8.

### Riser Shelf Surfaces Standard or ESD Laminate with "T" Mold

Pro-Line's Riser shelves turn any of our stations into a Technical Work Station. Heavy gauge painted steel frame easily mounts to all of our models. The -3 includes 6 built-in 15 amp 120-volt electrical outlets across rear support. **Front brace of riser removed to show electrical outlets.**

**In Stock in Light Blue only.**

## ADDITIONAL IN STOCK RISER OPTIONS

Optional enclosure panel for riser leg. Shown on inside front cover.

**In Light Blue Only for QS**

<b>S-2</b>	Enclosure Panel Wgt. (lbs) 2.5
------------	-----------------------------------

The 6RE is a pair of 6" riser extensions. Raises height of riser to 24" over all height.

<b>6RE</b>	Riser Extensions Wgt. (lbs) 12/pr
------------	--------------------------------------

The S-2EP electrical panel allows you to add additional outlets to either -1 or -2 riser shelves. Price includes panel with 6 outlets, on/off switch, built-in circuit breaker and power cord.

<b>S-2EP</b>	Electrical Panel Wgt. (lbs) 8
--------------	----------------------------------



# TERMS AND CONDITIONS

Orders placed with the factory are due and payable net 30 days. The F.O.B. point is our factory in Haverhill, MA. The minimum order amount is \$25.00, and all cancelled standard orders are subject to a cancellation charge of up to 25% of the original order. In addition, all orders, standard or special, entered upon our books cannot be countermanded except with our consent, and then only upon terms that will indemnify us against loss.

## Shipment

All orders ship Knocked Down (**KD**). For Factory assembled or installed orders please call 1-800-739-9067

## Damage in Transit

For your protection, examine each shipment carefully for external damage. If there is any evidence of damage or shortage in transit, insist that the delivery carrier make appropriate notation on the freight bill of lading before you sign anything. If, after receipt, any internal or hidden damage is discovered, immediately notify the carrier and request an inspection report to support your claim. Claims for damage or shortages in transit must be filed with the delivery carrier. Pro-Line will not accept any return of merchandise that has been damaged in transit. Your recourse is with the delivery carrier.

## Returned Merchandise

No goods are to be returned to Pro-Line without a written R.G.A. (returned goods authorization). A handling fee of 25% or \$25.00, whichever is greater, will be charged on all returned merchandise.

## Specifications

Pro-Line reserves the right to make changes at any time, without notice, in colors, prices, materials, equipment, specifications or models. Although every effort has been made to ensure the accuracy of all information contained in this catalog, Pro-Line cannot be held responsible for any omissions or typographical errors. Please check with your local Pro-Line representative or distributor, or contact the factory direct, for the latest and most complete information before ordering.

**Pro-Line** products are warranted to the original user to be free from defects in design, material and workmanship, given normal use and care, for a period of eleven (11) years of a single shift service, from the date of purchase.

With the exceptions noted below, Pro-Line, at its option, will repair or replace any products or part thereof which fails as a result of such a defect during the following warranty periods (prorated for multi shift operation).

All Pro-Line products (except as noted)	Eleven years
Operating components, functional mechanisms, high-wear parts such as casters	Five years
Wood or wood/metal framed products	Two years
Textiles, covering materials, foam, finishes, exposed wood, fabrics, laminated electrical components, and electric or hydraulic height adjustable bench components	One year

This warranty is limited to the replacement and/or repair only, of such defective part(s) authorized in writing to be returned to Pro-Line with transportation fees and costs prepaid by the purchaser, and provided that examination by Pro-Line discloses such defect(s). In no way shall Pro-Line be responsible for any damage by the carrier, abuse, negligence, misuse, user modifications, or customers material(s). Pro-Line does not warrant the matching of color, grain, or texture.

Accessories, components, parts, and laminates not manufactured by Pro-Line are warranted to the extent of the original manufacturer's warranty.

Pro-Line will not accept unauthorized fees or charges for expenses (i.e., labor and freight) incurred by the customer. Products which have been repaired or altered by anyone other than Pro-Line or without Pro-Line's written permission or, in our judgement, has been subject to misuse, neglect, accident, or use outside specifications by purchaser or others are excluded from this warranty.

This warranty is in lieu of any other expressed or implied warranty, including any implied of merchantability or fitness for a particular purpose, and of any other obligations or liability on the part of Pro-Line.

# SECTION I

# BASE WORKSTATIONS

BASE WORKSTATIONS

## HOW TO CONFIGURE A MODULAR WORKSTATION

First select a base model  
Example **HD603030PL-H11**

Model <b>HD</b>	Length <b>60</b>	Width <b>30</b>	Height <b>30</b>	Worksurface <b>PL</b>	Color <b>H11</b>
The Prefix designates the model.	The first two numbers designate the length in inches.	The second two numbers designate the width in inches.	The last two numbers designate the height in inches. For Custom Heights this # will change	Select type of worksurface required (PL) Standard Laminate (ESD) ESD Laminate (SM) Solid Maple	Select a color choice from inside back cover.

Next, select optional accessories. See page 57 for an example

Example 1 Part # <b>UR60-H11</b>			Example 2 Part # <b>BH60-H11</b>			Example 3 Part # <b>FR60-H11</b>		
Item	Size	Color	Item	Size	Color	Item	Size	Color
<b>UR</b>	<b>60</b>	<b>H11</b>	<b>BH</b>	<b>60</b>	<b>H11</b>	<b>FR</b>	<b>60</b>	<b>H11</b>
Uprights	60" High	Beige	Bin Holder	60" Long	Beige	Footrest	60" Long	Beige
Example 4 Part # <b>OLF60-H11</b>			Example 5 Part # <b>CSPL1260PL-H11</b>			Example 6 Part # <b>HDLE-6-H11</b>		
Item	Size	Color	Item	Size	Color	Item	Size	Color
<b>OLF</b>	<b>60</b>	<b>H11</b>	<b>CSPL</b>	<b>60</b>	<b>H11</b>	<b>HDLE</b>	<b>6</b>	<b>H11</b>
Light Frame	60" Long	Beige	Shelf	12" x 60"	Beige	Leg Extenders	6" adjustment	Beige

All ESD Stations require ground kits for proper operation. See page 42 for options.

### MODEL HD



Standard Height 30"H.

Tops also available in Stainless, Polypropylene, Epoxy Resin, Etc.

"The most workstation for your money."

The esthetics of the Model HD combined with the heavy duty, independent 4 leg design and the almost infinite selection of modular accessories have made this model the workstation of choice for production/lab areas at most every Fortune 500 company in America. With an unbeatable price vs. quality, you cannot go wrong with our most popular model. 2" Square tube legs with high quality paint finish. 5,000 lbs. capacity.

T mold protection around the perimeter of laminate tops. (Matching T mold, laminate face modular drawers to protect operators legs and clothing.)

Optional casters are available to mobilize all basic workstations.

**Additional charges apply per station for other heights. All ESD stations require ground kits unless otherwise noted.**

**Make any unit mobile.. Optional Casters on page 40**



BASE PART NO. / SIZE (Indicate custom height)	PLASTIC LAMINATE		E.S.D.		SOLID MAPLE			
	HD4830	"(Hgt)	HD483030PL	HD483030ESD	HD483030SM			
48"Lx30"W			Wgt. lbs 100	Wgt. Cap 5000	Wgt. lbs 100	Wgt. Cap 5000	Wgt. lbs 124	Wgt. Cap 5000
60"Lx30"W			Wgt. lbs 115	Wgt. Cap 5000	Wgt. lbs 115	Wgt. Cap 5000	Wgt. lbs 145	Wgt. Cap 5000
72"Lx30"W			Wgt. lbs 130	Wgt. Cap 5000	Wgt. lbs 130	Wgt. Cap 5000	Wgt. lbs 167	Wgt. Cap 5000
96"Lx30"W			Wgt. lbs 160	Wgt. Cap 5000	Wgt. lbs 160	Wgt. Cap 5000	Wgt. lbs 209	Wgt. Cap 5000
48"Lx36"W			Wgt. lbs 108	Wgt. Cap 5000	Wgt. lbs 108	Wgt. Cap 5000	Wgt. lbs 137	Wgt. Cap 5000
60"Lx36"W			Wgt. lbs 125	Wgt. Cap 5000	Wgt. lbs 125	Wgt. Cap 5000	Wgt. lbs 162	Wgt. Cap 5000
72"Lx36"W			Wgt. lbs 140	Wgt. Cap 5000	Wgt. lbs 140	Wgt. Cap 5000	Wgt. lbs 184	Wgt. Cap 5000
96"Lx36"W			Wgt. lbs 170	Wgt. Cap 5000	Wgt. lbs 170	Wgt. Cap 5000	Wgt. lbs 229	Wgt. Cap 5000

Model HD can be made to accept side uprights for mounting of accessories to either side. **96" long stations include a lower upright support.** For 6" Height adjustment in 1" increments see page 30.

See our stock program on the inside front cover for available colors





Make any unit mobile...  
Optional Casters on page 40



## MODEL CHD WORKSTATIONS

### THE MODEL CHD

BASE PART NO. / SIZE (Indicate custom height)	PLASTIC LAMINATE		E.S.D.		SOLID MAPLE	
	Wgt. lbs	Wgt. Cap	Wgt. lbs	Wgt. Cap	Wgt. lbs	Wgt. Cap
<b>CHD4830</b> "(Hgt)	<b>CHD483030PL</b>		<b>CHD483030ESD</b>		<b>CHD483030SM</b>	
48"Lx30"W	117	850	119	850	143	850
<b>CHD6030</b> "(Hgt)	<b>CHD603030PL</b>		<b>CHD603030ESD</b>		<b>CHD603030SM</b>	
60"Lx30"W	138	850	138	850	168	850
<b>CHD7230</b> "(Hgt)	<b>CHD723030PL</b>		<b>CHD723030ESD</b>		<b>CHD723030SM</b>	
72"Lx30"W	158	850	158	850	195	850
<b>CHD4836</b> "(Hgt)	<b>CHD483630PL</b>		<b>CHD483630ESD</b>		<b>CHD483630SM</b>	
48"Lx36"W	126	850	126	850	155	850
<b>CHD6036</b> "(Hgt)	<b>CHD603630PL</b>		<b>CHD603630ESD</b>		<b>CHD603630SM</b>	
60"Lx36"W	158	850	158	850	195	850
<b>CHD7236</b> "(Hgt)	<b>CHD723630PL</b>		<b>CHD723630ESD</b>		<b>CHD723630SM</b>	
72"Lx36"W	168	850	168	850	212	850

Utilizing the same accessories as the Model HD, the Model CHD is for those who want the mobility of an independent workstation design but need the front leg recessed for leg clearance. Comes standard with a modesty panel. 850 lbs. capacity.

Optional telescoping legs available shown below.

**Standard fixed height 30"H.**

Other heights available-  
Additional charges apply



### LEG EXTENDER

**6" leg extenders on 1" increments.**

For the model CHD must be ordered at time of work station purchase.

PART NO.	DESCRIPTION	Wgt. (lbs)
<b>CHDLE-6</b>	6" Leg Extenders for the Model CHD	8



Shown with various accessories

Ergonomists at the world's largest manufacturers have recognized that repetitive motion injury can be greatly reduced and productivity greatly increased by changing positions during the work process. Ergo-Line allows operators of all sizes and physical characteristics to change work surface height at will. Our optional work surface tilting feature is available upon request.

- Adjusts 30" to 42" only.
- 330 lb. capacity.

For other height and weight requirements see the Model ELH on page 3.

## ERGO-LINE WORKSTATIONS

BASE PART NO. / SIZE	PLASTIC LAMINATE		E.S.D.		SOLID MAPLE	
	Wgt. lbs	Wgt. Cap	Wgt. lbs	Wgt. Cap	Wgt. lbs	Wgt. Cap
<b>EL4830</b> 30-42"	<b>EL4830PL</b>		<b>EL4830ESD</b>		<b>EL4830SM</b>	
48"Lx30"W	125	330	125	330	150	330
<b>EL4836</b> 30-42"	<b>EL4836PL</b>		<b>EL4836ESD</b>		<b>EL4836SM</b>	
48"Lx36"W	133	330	133	330	162	330
<b>EL6030</b> 30-42"	<b>EL6030PL</b>		<b>EL6030ESD</b>		<b>EL6030SM</b>	
60"Lx30"W	140	330	140	330	170	330
<b>EL6036</b> 30-42"	<b>EL6036PL</b>		<b>EL6036ESD</b>		<b>EL6036SM</b>	
60"Lx36"W	150	330	150	330	187	330
<b>EL7230</b> 30-42"	<b>EL7230PL</b>		<b>EL7230ESD</b>		<b>EL7230SM</b>	
72"Lx30"W	155	330	155	330	192	330
<b>EL7236</b> 30-42"	<b>EL7236PL</b>		<b>EL7236ESD</b>		<b>EL7236SM</b>	
72"Lx36"W	165	330	165	330	209	330

For Electric Hydraulic Push Button Height, consult factory. Part Number changes to **ELE**.

Consult factory for other height ranges, sizes and weight capacities.

See our stock program on the inside front cover for available colors

## HEAVY DUTY ERGO LINE – HAND CRANK

BASE WORKSTATIONS

BASE PART NO./SIZE Indicate custom height	PLASTIC LAMINATE		E.S.D.		SOLID MAPLE	
<b>ELH4830</b> "(Hgt)	<b>ELH4830PL</b>		<b>ELH4830ESD</b>		<b>ELH4830SM</b>	
48"Lx30"W	Wgt. lbs 125	Wgt. Cap 750	Wgt. lbs 125	Wgt. Cap 750	Wgt. lbs 150	Wgt. Cap 750
<b>ELH4836</b> "(Hgt)	<b>ELH4836PL</b>		<b>ELH4836ESD</b>		<b>ELH4836SM</b>	
48"Lx36"W	Wgt. lbs 133	Wgt. Cap 750	Wgt. lbs 133	Wgt. Cap 750	Wgt. lbs 160	Wgt. Cap 750
<b>ELH6030</b> "(Hgt)	<b>ELH6030PL</b>		<b>ELH6030ESD</b>		<b>ELH6030SM</b>	
60"Lx30"W	Wgt. lbs 140	Wgt. Cap 750	Wgt. lbs 140	Wgt. Cap 750	Wgt. lbs 170	Wgt. Cap 750
<b>ELH6036</b> "(Hgt)	<b>ELH6036PL</b>		<b>ELH6036ESD</b>		<b>ELH6036SM</b>	
60"Lx36"W	Wgt. lbs 150	Wgt. Cap 750	Wgt. lbs 150	Wgt. Cap 750	Wgt. lbs 187	Wgt. Cap 750
<b>ELH7230</b> "(Hgt)	<b>ELH7230PL</b>		<b>ELH7230ESD</b>		<b>ELH7230SM</b>	
72"Lx30"W	Wgt. lbs 155	Wgt. Cap 750	Wgt. lbs 155	Wgt. Cap 750	Wgt. lbs 192	Wgt. Cap 750
<b>ELH7236</b> "(Hgt)	<b>ELH7236PL</b>		<b>ELH7236ESD</b>		<b>ELH7236SM</b>	
72"Lx36"W	Wgt. lbs 165	Wgt. Cap 750	Wgt. lbs 165	Wgt. Cap 750	Wgt. lbs 209	Wgt. Cap 750
<b>ELH9630</b> "(Hgt)	<b>ELH9630PL</b>		<b>ELH9630ESD</b>		<b>ELH9630SM</b>	
96"Lx30"W	Wgt. lbs 155	Wgt. Cap 750	Wgt. lbs 155	Wgt. Cap 750	Wgt. lbs 192	Wgt. Cap 750
<b>ELH9636</b> "(Hgt)	<b>ELH9636PL</b>		<b>ELH9636ESD</b>		<b>ELH9636SM</b>	
96"Lx36"W	Wgt. lbs 165	Wgt. Cap 750	Wgt. lbs 165	Wgt. Cap 750	Wgt. lbs 209	Wgt. Cap 750



750 lb capacity vertical adjust station for applications that our standard 330 lb capacity Ergo Line does not address (Height range 11.812"). **Standard height adjustment 30.375" to 42.187"**. Other heights available - Additional charges apply

For Electric Hydraulic Push Button Height Adjustment add **Prefix ELHE** to the Part number. Additional charges apply, please consult factory

## Simply the best ergonomic station ever made.

This is the station for the next millennium.

- **UL and CSA approved motor and control box.**
- **1000 lbs. capacity.**
- **Three-position programmable height memory switch.**
- **Ships "KD" or assembled.**
- **16" of travel.**
- **Unit adjusts from 30.5" to 46.5" only. For other heights see ELHE.**

The MVSII is an electric height adjustable workstation. The unit adjusts from 30.5" to 46.5" with 1000 lbs. capacity at a travel rate of .5" per second. Sturdy but simple design allows unit to ship "KD" or assembled. Unit assembles in the field in minutes.

Programmable switch allows operator to program up to three heights into memory or use the up/down switch for full 16" of travel. Our modular drawer system and other under the surface options can be added in the field.

The MVSII is "In Stock" in both 60" L x 30"W and 72" L x 30" W in light blue.

BASE PART NO./SIZE	PLASTIC LAMINATE		E.S.D.		SOLID MAPLE	
<b>MVSII4830</b>	<b>MVSII4830PL</b>		<b>MVSII4830ESD</b>		<b>MVSII4830SM</b>	
48"Lx30"W	Wgt. lbs 190	Wgt. Cap 1000	Wgt. lbs 190	Wgt. Cap 1000	Wgt. lbs 214	Wgt. Cap 1000
<b>MVSII4836</b>	<b>MVSII4836PL</b>		<b>MVSII4836ESD</b>		<b>MVSII4836SM</b>	
48"Lx36"W	Wgt. lbs 214	Wgt. Cap 1000	Wgt. lbs 214	Wgt. Cap 1000	Wgt. lbs 238	Wgt. Cap 1000
<b>MVSII6030</b>	<b>MVSII6030PL</b>		<b>MVSII6030ESD</b>		<b>MVSII6030SM</b>	
60"Lx30"W	Wgt. lbs 210	Wgt. Cap 1000	Wgt. lbs 210	Wgt. Cap 1000	Wgt. lbs 240	Wgt. Cap 1000
<b>MVSII6036</b>	<b>MVSII6036PL</b>		<b>MVSII6036ESD</b>		<b>MVSII6036SM</b>	
60"Lx36"W	Wgt. lbs 230	Wgt. Cap 1000	Wgt. lbs 230	Wgt. Cap 1000	Wgt. lbs 272	Wgt. Cap 1000
<b>MVSII7230</b>	<b>MVSII7230PL</b>		<b>MVSII7230ESD</b>		<b>MVSII7230SM</b>	
72"Lx30"W	Wgt. lbs 230	Wgt. Cap 1000	Wgt. lbs 230	Wgt. Cap 1000	Wgt. lbs 272	Wgt. Cap 1000
<b>MVSII7236</b>	<b>MVSII7236PL</b>		<b>MVSII7236ESD</b>		<b>MVSII7236SM</b>	
72"Lx36"W	Wgt. lbs 250	Wgt. Cap 1000	Wgt. lbs 250	Wgt. Cap 1000	Wgt. lbs 292	Wgt. Cap 1000



## MILLENNIUM II. "STATE OF THE ART" Electric Height Adjustable Workstation

*"Are your Production Areas ready for the next Millennium?"*



Model MVSII

Shown with optional accessories

See our stock program on the inside front cover for available colors

## FLEXLINE SYSTEMS – OVER CONVEYOR!

Pro-Line's FlexLine systems make ideal work stands when a complete workstation is not needed. Pro-Line's modular accessories easily mount to these fully welded structural steel frames. Unit includes two (2) 24" long horizontal leg supports and one open Frame 3.25" thick. 500 lbs. capacity.

**Please note when purchasing accessories for FlexLine stations add the letters FL to the end of our part numbers. Please use any accessories in Accessory section.**

PART NO.	DESCRIPTION	Wgt. (lbs)
OF3648	Open Frame 36"W x 48"H	51
OF4848	Open Frame 48"W x 48"H	51
OF3666	Open Frame 36"W x 66"H	69
OF4866	Open Frame 48"W x 66"H	69
OF6066	Open Frame 60"W x 66"H	69
OF3680	Open Frame 36"W x 80"H	83
OF4880	Open Frame 48"W x 80"H	83

Add 2.75" to overall height



**Open Frames are also available  
Double sided.  
Additional charges apply**

### SUSPENDED WORKSURFACE/SHELF

Cantilevers over or under any conveyor.  
Variety of worksurface materials available.



### ERGONOMIC POSITIONING AUXILIARY WORKSURFACE

Position monitors, parts bins, subassemblies, etc. for ideal accessibility during work process. Puts the work at your fingertips.



### OVERHEAD LIGHTING

Variety of lighting available.



### CANTILEVER TOOL BALANCER – Made for any span.

**Make any unit mobile....**

**Optional Casters on page 40**

# FLEXLINE SYSTEMS

## FLEXLINE



Open Frame System allows tops and accessories to be supported off both sides of panel. **Shown as double sided unit.**

Includes open frame supports and work surface. Shown with optional accessories. 750 lbs. capacity.

**When ordering accessories for FlexLine stations, add FL to end of part number.**

**Overall height 69" without light.**

Please specify workstation to ship KD or fully assembled.

TOP	FLEXLINE 48" x 30"		FLEXLINE 60" x 30"	
	PART #	WEIGHT	PART #	WEIGHT
Plastic Single Side	FL4830PL	129	FL6030PL	159
Conductive Single Side	FL4830ESD	129	FL6030ESD	159
Plastic Double Side	FL4830PLD	198	FL6030PLD	241
Conductive Double Side	FL4830ESDD	198	FL6030ESDD	241

BASE WORKSTATIONS

## PROGRESSIVE ASSEMBLY

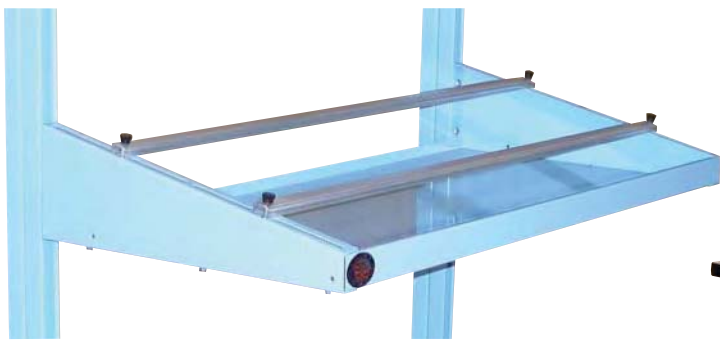

Progressive Assembly rail system for sliding along assembly of PC board modules.

**Mounts to Flexline frame.**

Can also be mounted to worksurface of other models.

**Please Specify Model**

PART NO.	DESCRIPTION	Wgt. (lbs)	Wgt. (kgs)
PAS48	Fits 48" Frame / 121.92 cm	19	8.6

## TECHNICAL WORKSTATION (COCKPIT STATION)

Similar in construction to the Model HD with a 72" x 42" "T" molded worksurface cut out 30" wide x 18" deep in front. 750 lbs. capacity.

This workstation is popular with technicians who need extra room for instrumentation and documents. Often ordered with shelving, drawers and pull out writing surfaces.



PART NO.	DESCRIPTION	Wgt. (lbs)	Wgt. (kgs)
TW724230P	72"L x 42"W x 30"H 192/88 cm x 106.68 cm x 76.20 cm	148	66

**PLEASE CONSULT THE FACTORY FOR ALL YOUR CUSTOM FABRICATION REQUIREMENTS.**

## TECHNICIAN STATION THE MODEL TSHD

*One great station, one great price,  
one easy to order part number.*

The **Model TSHD** comes complete as shown. Price includes base unit 30" or 36" deep and 60" or 72" long (Work surface height adjusts from 30" to 36.) modular drawers 6" and 12" with laminate face personal pad lock drawer with hanging kits riser 12" deep x 18" high with 6 pre-wired outlets, and a 90° rolled front edge. ESD stations also include ESD work surface and ESD shelf surface and a standard ground kit with two banana jacks.

**The model TSHD is in stock with white surfaces and light blue frames.**



Front brace of riser removed to show electrical outlets.

BASE PART NO./ SIZE	Plastic Laminate	ESD Laminate
<b>TSHD6030</b> 60"L x 30"W	<b>TSHD6030PL</b> Wgt (lbs) 254	<b>TSHD6030ESD</b> Wgt (lbs) 255
<b>TSHD7230</b> 72"L x 30"W	<b>TSHD7230PL</b> Wgt (lbs) 278	<b>TSHD7230ESD</b> Wgt (lbs) 278
<b>TSHD6036</b> 60"L x 36"W	<b>TSHD6036PL</b> Wgt (lbs) 264	<b>TSHD6036ESD</b> Wgt (lbs) 265
<b>TSHD7236</b> 72"L x 36"W	<b>TSHD7236PL</b> Wgt (lbs) 288	<b>TSHD7236ESD</b> Wgt (lbs) 288



## ENCLOSED CABINET BENCH WITH SLIDING DOORS



Shown with optional light, shelf and power supply.

The **Model ECB/HD** Enclosed Cabinet bench built on the Model HD frame has been in use since 1979. This station allows you to neatly store and secure items in your plant. With our modular design, you can easily add accessories to make this station meet your requirements. (Standard height 30" high) Price includes lock. Other Heights available at an additional charge

BASE PART NO./ SIZE Indicate custom height	PLASTIC LAMINATE		E.S.D.		SOLID MAPLE 13/4"	
<b>ECB4830</b> "(Hgt)	<b>ECB483030PL</b>		<b>ECB483030ESD</b>		<b>ECB483030SM</b>	
48"Lx30"W	Wgt. lbs 245	Wgt. Cap 3000	Wgt. lbs 245	Wgt. Cap 3000	Wgt. lbs 265	Wgt. Cap 3000
<b>ECB4836</b> "(Hgt)	<b>ECB483630PL</b>		<b>ECB483630ESD</b>		<b>ECB483630SM</b>	
48"Lx36"W	Wgt. lbs 265	Wgt. Cap 3000	Wgt. lbs 265	Wgt. Cap 3000	Wgt. lbs 285	Wgt. Cap 3000
<b>ECB6030</b> "(Hgt)	<b>ECB603030PL</b>		<b>ECB603030ESD</b>		<b>ECB603030SM</b>	
60"Lx30"W	Wgt. lbs 275	Wgt. Cap 3000	Wgt. lbs 275	Wgt. Cap 3000	Wgt. lbs 290	Wgt. Cap 3000
<b>ECB6036</b> "(Hgt)	<b>ECB603630PL</b>		<b>ECB603630ESD</b>		<b>ECB603630SM</b>	
60"Lx36"W	Wgt. lbs 285	Wgt. Cap 3000	Wgt. lbs 285	Wgt. Cap 3000	Wgt. lbs 290	Wgt. Cap 3000
<b>ECB7230</b> "(Hgt)	<b>ECB723030PL</b>		<b>ECB723030ESD</b>		<b>ECB723030SM</b>	
72"Lx30"W	Wgt. lbs 301	Wgt. Cap 3000	Wgt. lbs 301	Wgt. Cap 3000	Wgt. lbs 326	Wgt. Cap 3000
<b>ECB7236</b> "(Hgt)	<b>ECB723630PL</b>		<b>ECB723630ESD</b>		<b>ECB723630SM</b>	
72"Lx36"W	Wgt. lbs 321	Wgt. Cap 3000	Wgt. lbs 321	Wgt. Cap 3000	Wgt. lbs 335	Wgt. Cap 3000

**PLEASE CONSULT THE FACTORY FOR ALL YOUR CUSTOM FABRICATION REQUIREMENTS.**



Shown with optional risers (see page 8)  
For 90 degree rolled front edge additional charges apply  
Easily mix and match cabinets to meet your requirements  
Standard and ESD surfaces come with  
"T" Mold edges standard.

**Available in  
Powder Coat  
Textured  
Finish Only**

Heavy Duty Pedestal Workstations (Series "PCP") featuring Heavy duty Modular Cabinets 18"W x 26"D. Drawers feature 95% extension slides with 100 Lb. capacity per drawer. Drawer insides are slotted to accept optional dividers every 1" for optimal organization.

Stations priced below with 6" high base. Overall height of station with laminate or ESD surface is 35.5" set at the lowest point. Overall height with Maple surface is 36" set at the lowest point. Glides allow for 1" of adjustment, (Other heights available.)





**Textured color options shown on Page 52.** When ordering two tone color scheme, please specify desired colors for housings and drawers.



Drawer Dividers	
Part No.	wgt
3" DD3	(1.5) lbs
6" DD6	(2.5) lbs
12" DD12	(4.5) lbs

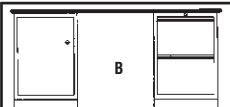
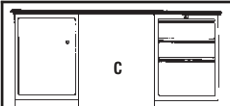

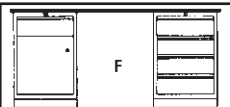
For other divider configurations, see page 57

# HEAVY DUTY PEDESTAL WORKSTATIONS (SERIES "PCP")

	Size	Plastic Laminate	E.S.D. Laminate	Solid 1 3/4" Maple
	60" L x 30"	PCP6030APL Wgt. (lbs)279	PCP6030AESD Wgt. (lbs)279	PCP6030ASM Wgt. (lbs)311
	72" L x 30"	PCP7230APL Wgt. (lbs) 291	PCP7230AESD Wgt. (lbs)291	PCP7230ASM Wgt. (lbs)328
	60" L x 30"	PCP6030BPL Wgt. (lbs)234	PCP6030BESD Wgt. (lbs)234	PCP6030BSM Wgt. (lbs)266
	72" L x 30"	PCP7230BPL Wgt. (lbs)246	PCP7230BESD Wgt. (lbs)246	PCP7230BSM Wgt. (lbs)283
	60" L x 30"	PCP6030CPL Wgt. (lbs)256	PCP6030CESD Wgt. (lbs)256	PCP6030CSM Wgt. (lbs)288
	72" L x 30"	PCP7230CPL Wgt. (lbs)268	PCP7230CESD Wgt. (lbs)268	PCP7230CSM Wgt. (lbs)305
	60" L x 30"	PCP6030DPL Wgt. (lbs)256	PCP6030DES Wgt. (lbs)256	PCP6030DSM Wgt. (lbs)308
	72" L x 30"	PCP7230DPL Wgt. (lbs)288	PCP7230DES Wgt. (lbs)288	PCP7230DSM Wgt. (lbs)325
	60" L x 30"	PCP6030EPL Wgt. (lbs)264	PCP6030EESD Wgt. (lbs)264	PCP6030ESM Wgt. (lbs)296
	72" L x 30"	PCP7230EPL Wgt. (lbs)276	PCP7230EESD Wgt. (lbs)276	PCP7230ESM Wgt. (lbs)313
	60" L x 30"	PCP6030FPL Wgt. (lbs)290	PCP6030FESD Wgt. (lbs)290	PCP6030FSM Wgt. (lbs)322
	72" L x 30"	PCP7230FPL Wgt. (lbs)302	PCP7230FESD Wgt. (lbs)302	PCP7230FSM Wgt. (lbs)302
	60" L x 30"	PCP6030GPL Wgt. (lbs) 284	PCP6030GESD Wgt. (lbs)284	PCP6030GSM Wgt. (lbs)316
	72" L x 30"	PCP7230GPL Wgt. (lbs) 296	PCP7230GESD Wgt. (lbs)296	PCP7230GSM Wgt. (lbs)333
	60" L x 30"	PCP6030HPL Wgt. (lbs)300	PCP6030HESD Wgt. (lbs)300	PCP6030HSM Wgt. (lbs)332
	72" L x 30"	PCP7230HPL Wgt. (lbs) 312	PCP7230HESD Wgt. (lbs)312	PCP7230HSM Wgt. (lbs)349

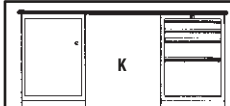
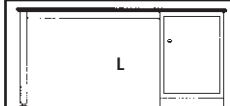
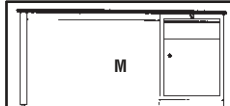
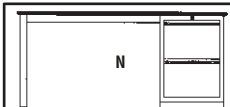
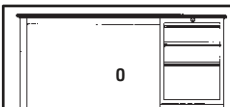
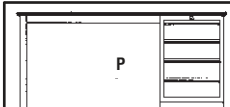
	Size	Plastic Laminate	E.S.D. Laminate	Solid 1 3/4" Maple
	60" L x 30"	PCP6030IPL Wgt. (lbs)312	PCP6030IESD Wgt. (lbs)312	PCP6030ISM Wgt. (lbs)344
	72" L x 30"	PCP7230IPL Wgt. (lbs)324	PCP7230IESD Wgt. (lbs)324	PCP7230ISM Wgt. (lbs)361
	60" L x 30"	PCP6030JPL Wgt. (lbs)307	PCP6030JESD Wgt. (lbs)307	PCP6030JSM Wgt. (lbs)339
	72" L x 30"	PCP7230JPL Wgt. (lbs)319	PCP7230JESD Wgt. (lbs)319	PCP7230JSM Wgt. (lbs)356
	60" L x 30"	PCP6030KPL Wgt. (lbs)284	PCP6030KESD Wgt. (lbs)284	PCP6030KSM Wgt. (lbs)316
	72" L x 30"	PCP7230KPL Wgt. (lbs)296	PCP7230KESD Wgt. (lbs)296	PCP7230KSM Wgt. (lbs)333
	60" L x 30"	PCP6030LPL Wgt. (lbs)147	PCP6030LES Wgt. (lbs)147	PCP6030LSM Wgt. (lbs)180
	72" L x 30"	PCP7230LPL Wgt. (lbs)296	PCP7230LES Wgt. (lbs)296	PCP7230LSM Wgt. (lbs)333
	60" L x 30"	PCP6030MPL Wgt. (lbs)158	PCP6030MESD Wgt. (lbs)158	PCP6030MSM Wgt. (lbs)190
	72" L x 30"	PCP7230MPL Wgt. (lbs)170	PCP7230MESD Wgt. (lbs)170	PCP7230MSM Wgt. (lbs)207
	60" L x 30"	PCP6030NPL Wgt. (lbs)175	PCP6030NESD Wgt. (lbs)175	PCP6030NSM Wgt. (lbs)207
	72" L x 30"	PCP7230NPL Wgt. (lbs)187	PCP7230NESD Wgt. (lbs)187	PCP7230NSM Wgt. (lbs)224
	60" L x 30"	PCP6030OPL Wgt. (lbs)182	PCP6030OESD Wgt. (lbs)182	PCP6030OSM Wgt. (lbs)214
	72" L x 30"	PCP7230OPL Wgt. (lbs)194	PCP7230OESD Wgt. (lbs)194	PCP7230OSM Wgt. (lbs)231
	60" L x 30"	PCP6030PPL Wgt. (lbs)182	PCP6030PESD Wgt. (lbs)182	PCP6030PSM Wgt. (lbs)214
	72" L x 30"	PCP7230PPL Wgt. (lbs)326	PCP7230PESD Wgt. (lbs)326	PCP7230PSM Wgt. (lbs)363

Gang Locks Sold separately

BASE WORKSTATIONS

(Cabinet workstations placed back to back require two (2) risers or special 24" wide risers available upon request.) Double tier risers also available upon request. **Note: Risers are 18" in height.** Risers shown with optional S-2 panel.

## MODULAR INSTRUMENT SHELF

### See our stock program on the inside front cover for available colors

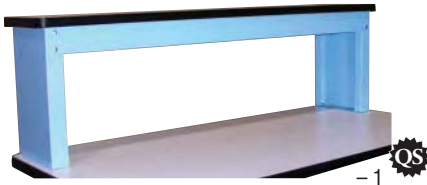

No Electrical Outlets.

<b>12" WIDE</b>	SIZE	Plastic Laminate	E.S.D. Laminate	Solid 1 3/4" Maple
	60" x 12"	<b>R6012-1PL</b> Wgt. (lbs) 41	<b>R6012-1ESD</b> Wgt. (lbs) 41	<b>R6012-1SM</b> Wgt. (lbs) 51
	72" x 12"	<b>R7212-1PL</b> Wgt. (lbs) 48	<b>R7212-1ESD</b> Wgt. (lbs) 48	<b>R7212-1SM</b> Wgt. (lbs) 58
	60" x 12"	<b>R6012-2PL</b> Wgt. (lbs) 43	<b>R6012-2ESD</b> Wgt. (lbs) 43	<b>R6012-2SM</b> Wgt. (lbs) 53
	72" x 12"	<b>R7212-2PL</b> Wgt. (lbs) 50	<b>R7212-2ESD</b> Wgt. (lbs) 50	<b>R7212-2SM</b> Wgt. (lbs) 60

<b>18" WIDE</b>	SIZE	Plastic Laminate	E.S.D. Laminate	Solid Maple
	60" x 18"	<b>R6018-1PL</b> Wgt. (lbs) 46	<b>R6018-1ESD</b> Wgt. (lbs) 46	<b>R6018-1SM</b> Wgt. (lbs) 55
	72" x 18"	<b>R7218-1PL</b> Wgt. (lbs) 53	<b>R7218-1ESD</b> Wgt. (lbs) 53	<b>R7218-1SM</b> Wgt. (lbs) 61
	60" x 18"	<b>R6018-2PL</b> Wgt. (lbs) 46	<b>R6018-2ESD</b> Wgt. (lbs) 46	<b>R6018-2SM</b> Wgt. (lbs) 55
	72" x 18"	<b>R7218-2PL</b> Wgt. (lbs) 53	<b>R7218-2ESD</b> Wgt. (lbs) 53	<b>R7218-2SM</b> Wgt. (lbs) 61



Electrical Outlets in One Leg.

<b>12" WIDE</b>	SIZE	Plastic Laminate	E.S.D. Laminate	Solid 1 3/4" Maple
	60" x 12"	<b>R6012-3PL</b> Wgt. (lbs) 46	<b>R6012-3ESD</b> Wgt. (lbs) 46	<b>R6012-3SM</b> Wgt. (lbs) 56
	72" x 12"	<b>R7212-3PL</b> Wgt. (lbs) 53	<b>R7212-3ESD</b> Wgt. (lbs) 53	<b>R7212-3SM</b> Wgt. (lbs) 63
	60" x 12"	<b>R6012-4PL</b> Wgt. (lbs) 47	<b>R6012-4ESD</b> Wgt. (lbs) 47	<b>R6012-4SM</b> Wgt. (lbs) 57
	72" x 12"	<b>R7212-4PL</b> Wgt. (lbs) 54	<b>R7212-4ESD</b> Wgt. (lbs) 54	<b>R7212-4SM</b> Wgt. (lbs) 64

<b>18" WIDE</b>	SIZE	Plastic Laminate	E.S.D. Laminate	Solid 1 3/4" Maple
	60" x 18"	<b>R6018-3PL</b> Wgt. (lbs) 46	<b>R6018-3ESD</b> Wgt. (lbs) 46	<b>R6018-3SM</b> Wgt. (lbs) 55
	72" x 18"	<b>R7218-3PL</b> Wgt. (lbs) 53	<b>R7218-3ESD</b> Wgt. (lbs) 53	<b>R7218-3SM</b> Wgt. (lbs) 61
	60" x 18"	<b>R6018-4PL</b> Wgt. (lbs) 46	<b>R6018-4ESD</b> Wgt. (lbs) 46	<b>R6018-4SM</b> Wgt. (lbs) 55
	72" x 18"	<b>R7218-4PL</b> Wgt. (lbs) 53	<b>R7218-4ESD</b> Wgt. (lbs) 53	<b>R7218-4SM</b> Wgt. (lbs) 61



Electrical Outlets Across Rear Brace.



Electrical Outlets Both Legs.

18" Wide Shelves have a 4" overhang front and rear.

### Riser Shelf Surfaces Standard or ESD laminate with "T" mold

Pro-Line's Riser shelves turn any of our stations into a Technical Work Station. Heavy gauge painted steel frame easily mounts to all of our models. The -3 includes 6 built-in 15 amp 120-volt electrical outlets across rear support.



S-2P Electrical Panel

The S-2EP electrical panel allows you to add additional outlets to either -1 or -2 riser shelves. Price includes panel with 6 outlets on/off switch, built-in circuit breaker and power cord.



S-2EP  
Wgt. (lbs) 8



6RE Riser Extensions

Optional enclosure panel for riser leg.

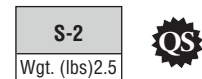

S-2  
Wgt. (lbs) 2.5

The 6RE is a pair of 6" riser extensions. Raises height of riser to 24" overall height.

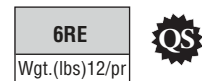

6RE  
Wgt. (lbs) 12/pr

### LAN STATION

These units are priced complete with a 24" x 36" worksurface, two AMS1836, MA-1, CPU holder, power supply and wire management trough. Standard unit is 36" wide x 69" high and 36" wide x 83" high. Easily bolts together to make unit as long as you need.

PART NO.	DESCRIPTION	Wgt. (lbs)
<b>LAN3666</b>	36" Wide x 69" High open frame	145
<b>LAN3680</b>	36" Wide x 83" High open frame	165

For additional LAN Stations see page 24.

### CPU HOLDER

CPU Holder mounts under work surface for convenient storage of CPU. Painted steel to match workstation.

PART NO.	DESCRIPTION	Wgt. (lbs)
<b>CPU</b>	8"W x 18"D x 18"H I.D.	15

Requires CPUHK hanging kit.



### BACK LIGHT STATIONS

Light fixture beneath surface illuminates translucent plastic top. For film inspection, these units are used mainly in optical and medical applications. Built on our model CHD design 120 volt 15 amp.

PART NO.	DESCRIPTION	Wgt. (lbs)
<b>BL483030</b>	Back Light Station 60"L x 30"W	235
<b>BL483630</b>	Back Light Station 60"L x 36"W	240



### Standard Height 30"

Other heights available- Additional charges apply  
Height Adjustable with Tilt Available

Shown with optional tilt. Add ET-1 See page 36.  
Shown with optional MVSII base

**PLEASE CONSULT THE FACTORY FOR ALL YOUR CUSTOM FABRICATION REQUIREMENTS.**



**“EASY GLIDER” • “POP UP BALL TRANSFERS”**

BASE WORKSTATIONS

“Pop Up” Ball transfers assist in transfer and positioning of materials in production. Ball transfers raise .250" above surface by activating pneumatic toggle switch. Work in process is then slid on to station. When load is in position, ball transfers are retracted and load is stabilized. Standard stations require 80 PSI of shop air to operate. Retractable ball transfer stations are available in half or full length coverage of surface. Two ball patterns are available: standard 6" x 6" pattern and heavy duty 3" x 6". Modular design allows for mounting of optional accessories. Stations feature a solid maple surface or an E.S.D., Electro Static Discharge Top. Heavy Duty 2" square tubular legs offer stability and esthetics. Leg extenders allow surface height to be set from 30" to 36". Footrest included.

**Optional foot pedal control available at an additional charge  
Not Shown**

**Lever Operated Transfer Stations require no shop air.**



Handle Mounts on left front corner not as shown.

Additional charges apply for Lever Operation  
Add "L to the end of part#



Photo shown with optional accessories.

**SD-Standard Density 6" x 6" Ball Pattern**

HALF COVERAGE SD	PART NO.	Wgt.	Cap. Lbs.	MAPLE  CONDUCTIVE
	RT4830HCSDM	150	200	
	RT4836HCSDM	160	200	
	RT6030HCSDM	170	200	
	RT6036HCSDM	180	200	
	RT7230HCSDM	185	200	
	RT7236HCSDM	195	200	
	RT4830HCSDC	140	200	
	RT4836HCSDC	150	200	
	RT6030HCSDC	160	200	
	RT6036HCSDC	170	200	
RT7230HCSDC	175	200		
RT7236HCSDC	185	200		

FULL COVERAGE SD	PART NO.	Wgt.	Cap. Lbs.	MAPLE  CONDUCTIVE
	RT4830FCSDM	185	400	
	RT4836FCSDM	195	400	
	RT6030FCSDM	205	400	
	RT6036FCSDM	225	400	
	RT7230FCSDM	225	400	
	RT7236FCSDM	235	400	
	RT4830FCSDC	165	400	
	RT4836FCSDC	170	400	
	RT6030FCSDC	195	400	
	RT6036FCSDC	175	400	
RT7230FCSDC	210	400		
RT7236FCSDC	220	400		

M-Solid Maple HC-Half Coverage

**HD-High Density 3" x 6" Ball Pattern**

HALF COVERAGE HD	PART NO.	Wgt.	Cap. Lbs.	MAPLE  CONDUCTIVE
	RT4830HCHDM	162	400	
	RT4836HCHDM	172	400	
	RT6030HCHDM	180	400	
	RT6036HCHDM	190	400	
	RT7230HCHDM	205	400	
	RT7236HCHDM	205	400	
	RT4830HCHDC	152	400	
	RT4836HCHDC	162	400	
	RT6030HCHDC	170	400	
	RT6036HCHDC	180	400	
RT7230HCHDC	195	400		
RT7236HCHDC	210	400		

FULL COVERAGE HD	PART NO.	Wgt.	Cap. Lbs.	MAPLE  CONDUCTIVE
	RT4830FCHDM	197	800	
	RT4836FCHDM	207	800	
	RT6030FCHDM	225	800	
	RT6036FCHDM	235	800	
	RT7230FCHDM	245	800	
	RT7236FCHDM	265	800	
	RT4830FCHDC	177	800	
	RT4836FCHDC	187	800	
	RT6030FCHDC	215	800	
	RT6036FCHDC	187	800	
RT7230FCHDC	222	800		
RT7236FCHDC	232	800		

C-Conductive FC-Full Coverage

When ordering HC please specify Left or Right.

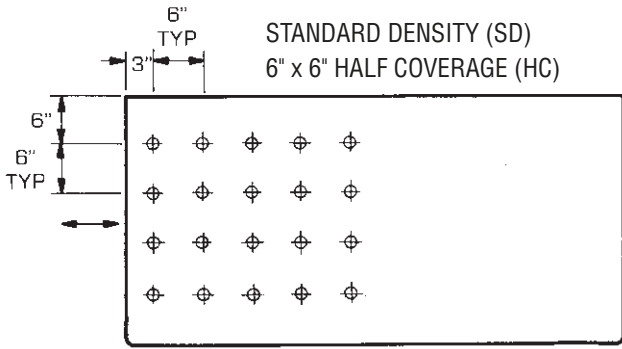

**STANDARD BALL  
TRANSFER LAYOUTS**

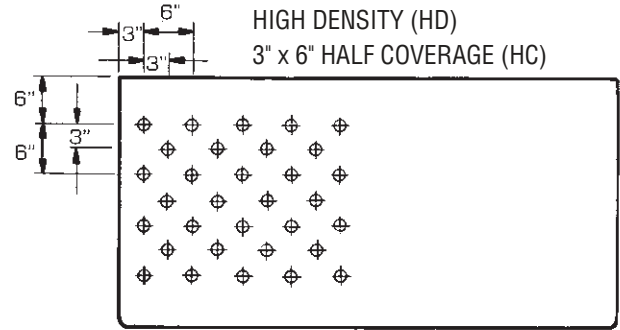

**When ordering HC half coverage please specify Transfers on Left or Right.**

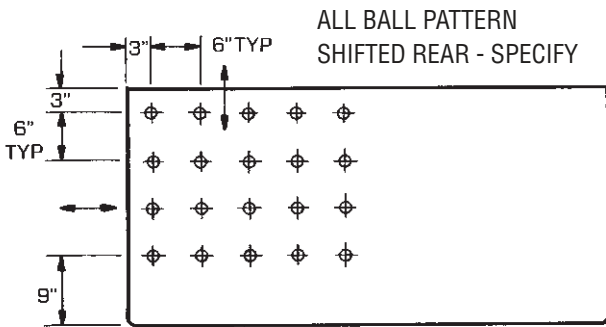
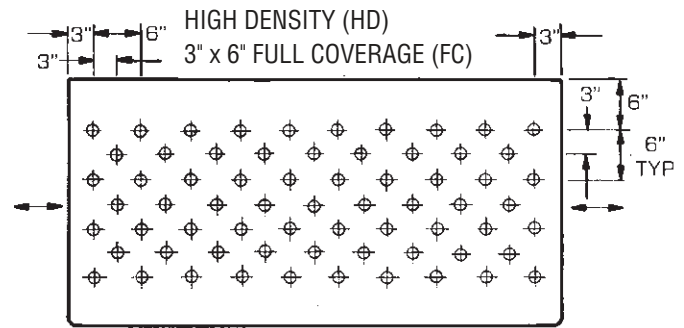
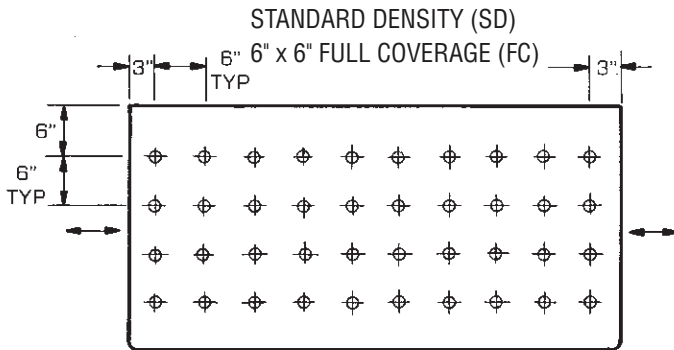

**NOTE:  
SIZES SHOWN ARE 60" x 30"  
(TOP SURFACE)**

**HEIGHT ADJUSTABLE RT STATIONS**

Add hand crank or electric height adjustment to the retractable ball transfer stations. 12" adjustment standard range is from 30" to 42" (please specify) 750 lbs capacity. Upcharge price includes 4 post system and a modesty panel and footrest.

Add letters as a prefix. ie: ELHRT designates hand crank height adjustable retractable ball transfer



**ELH and ELE can be added to all four post benches except the model CPB on page 20. Must be ordered at time of workstation purchase.**

**ELH UPCHARGE**

PART NO.	DESCRIPTION	Wgt. (lbs)
ELH	Upcharge to add 4 post Hand crank height adjustment	25
ELE	Upcharge to add 4 post Push button electric height adjustment	45

## BUILT IN GRAVITY ROLLER CONVEYOR

Do you manufacture on a progressive assembly line?

These units allow product to roll from one station to the next with a 12" x 12" Retractable Ball Transfer section in the center of the surface. 1" dia. x 12"L Rollers are set on 3" centers on either side of ball transfers. Transfers, when up, are set at same height as roller which allows product to be rotated. 200 lbs. capacity. Priced with standard laminate work surface. Please consult factory for other work surface choices

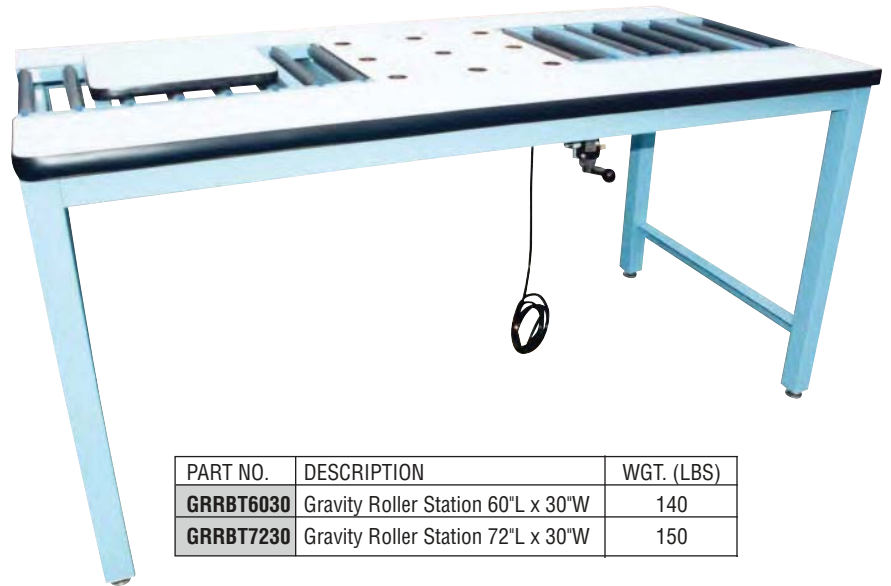

PART NO.	DESCRIPTION	WGT. (LBS)
GRRBT6030	Gravity Roller Station 60"L x 30"W	140
GRRBT7230	Gravity Roller Station 72"L x 30"W	150

## FIXED BALL TRANSFER TABLES

Fixed Ball Transfer Tables with ball casters surface mounted or recessed to match level of RBT unit also available. **(Shown with optional casters, making the cart mobile.)** 1000 lbs. capacity. Priced with standard laminate work surface. Please consult factory for other work surface choices

**Optional handle available at an additional charge**



**For Optional Casters See Page 40**

### HIGH DENSITY

PART NO.	DESCRIPTION	Wgt. (lbs)
BT483030-HD	48"L x 30"W 3x6 121.92cm x 76.20cm x 76.20cm	128
BT483630-HD	48"L x 36"W 3x6 121.92cm x 91.44cm x 76.20cm	145
BT603030-HD	60"L x 30"W 3x6 152.40cm x 76.20cm x 76.20cm	153
BT603630-HD	60"L x 36"W 3x6 152.40cm x 91.44cm x 76.20cm	172
BT723030-HD	72"L x 30"W 3x6 182.88cm x 76.20cm x 76.20cm	170
BT723630-HD	72"L x 36"W 3x6 182.88cm x 91.44cm x 76.20cm	197

### STANDARD DENSITY

PART NO.	DESCRIPTION	Wgt. (lbs)
BT483030-SD	48"L x 30"W 6x6 121.92cm x 76.20cm x 76.20cm	117
BT483630-SD	48"L x 36"W 6x6 121.92cm x 91.44cm x 76.20cm	128
BT603030-SD	60"L x 30"W 6x6 152.40cm x 76.20cm x 76.20cm	135
BT603630-SD	60"L x 36"W 6x6 152.40cm x 91.44cm x 76.20cm	150
BT723030-SD	72"L x 30"W 6x6 182.88cm x 76.20cm x 76.20cm	154
BT723630-SD	72"L x 36"W 6x6 182.88cm x 91.44cm x 76.20cm	176

## PRO-FLOW BELT CONVEYOR STATION

Variable speed belt conveyor built into our popular cantilever workstation. Works great with progressive assembly applications. UHMW work surface makes it easy to slide product on and off conveyor. Belts come in ESD polypropylene. Just pop in place side by side and plug in!

### Standard Features include

- Modular Plug and Play Design (units are prewired to be put into a line and plug into each other)
- Variable speed control (from 2 to 25 FPM)
- Premium polymer flat chain belting (ideal for low pressure accumulation)
- Self tracking / no tensioning required
- Energy efficient 115V AC (0.5 AMP)
- No scheduled maintenance
- Available in four widths 9", 12", 15" or 18"
- Belt capacity 100 lbs

Standard bench size is 60"L x 30"D. For other sizes consult factory. Standard height 34". Other heights available at an additional charge (Please specify at time of order.)

*Please specify direction of belt.*

PART NO.	DESCRIPTION	Wgt. (lbs)
BC60309ESD	Workstation with 9" ESD belt	161
BC603012ESD	Workstation with 12" ESD belt	168
BC603015ESD	Workstation with 15" ESD belt	175
BC603018ESD	Workstation with 18" ESD belt	182

(Shown with optional accessories above work surface.)

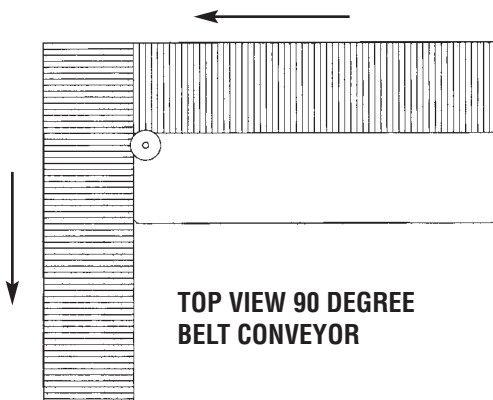

**TOP VIEW 90 DEGREE  
BELT CONVEYOR**



**BELT CAN BE MOUNTED TO THE FRONT OF THE  
WORKSTATION AS WELL.  
PLEASE SPECIFY WHEN ORDERING**



**Station shown with optional accessories**

### Manual Lifting: A backbone of Back injuries

11 million cases of back pain reported by workers are work-related —a significant fraction is linked to lifting

...12% of these workers stopped working or changed jobs due to back pain

Back injuries account for 20% of all injuries/illnesses in the workplace

...And they lost 543 million working days

Bad backs result in 25% of total workers compensation claims

**B  
A  
S  
E  
  
W  
O  
R  
K  
S  
T  
A  
T  
I  
O  
N  
S**

# DIMENSION NEXT

## MODULAR TECHNICAL SYSTEMS

### 'DIMENSION NEXT' EXPANDABLE MODULAR WORK STATIONS

Top quality finish meets modular ergonomic function with a price that is still affordable.

Solid slotted aluminum uprights allow work surface or optional accessories to be mounted anywhere along column. Heavy gauge steel frame bolts to top supports adding strength to the work surface and lateral support to the station. **In stock colors are textured beige powder coat finish with blue accents strips** Offers a durable finish with superior esthetics. Stations are 82.875" over all height. Work surfaces and optional accessories adjust independently of each other on double sided stations. 1000 lbs. capacity.

- Single sided starter station includes two uprights, two horizontal leg supports, one top frame assembly and one 180 degree front edge work surface with standard or ESD laminate.

- Single sided add-on station includes one upright, one horizontal leg support, one top frame assembly and one 180 degree front edge work surface with standard or ESD laminate.
- Double sided starter station includes two uprights, two back to back horizontal leg supports, two top frame assemblies and two 180 degree work surfaces with standard or ESD laminate.
- Double sided add-on station includes one upright, one back to back horizontal leg support, two top frame assemblies and two 180 degree front edge work surfaces with standard or ESD laminate.

(each row requires one starter unit)

**In Stock 60" & 72" Long**



Available in  
Powder Coat  
Textured  
Finish Only

Textured color options shown on page 52

Base Part NO./ Size	Plastic Laminate	ESD Laminate
<b>DN4830SS</b> 48"L x 30"W <b>Single Starter</b>	<b>DN4830SSPL</b> Wgt. (lbs) 177	<b>DN4830SSESD</b> Wgt. (lbs) 177
<b>DN6030SS</b> 60"L x 30"W <b>Single Starter</b>	<b>DN6030SSPL</b> Wgt. (lbs) 198	<b>DN6030SSESD</b> Wgt. (lbs) 198
<b>DN7230SS</b> 72"L x 30"W <b>Single Starter</b>	<b>DN7230SSPL</b> Wgt. (lbs) 217	<b>DN7230SSESD</b> Wgt. (lbs) 217
<b>DN4830SA</b> 48"L x 30"W <b>Single Add-On</b>	<b>DN4830SAPL</b> Wgt. (lbs) 130	<b>DN4830SAESD</b> Wgt. (lbs) 130
<b>DN6030SA</b> 60"L x 30"W <b>Single Add-On</b>	<b>DN6030SAPL</b> Wgt. (lbs) 148	<b>DN6030SAESD</b> Wgt. (lbs) 148
<b>DN7230SA</b> 72"L x 30"W <b>Single Add-On</b>	<b>DN7230SAPL</b> Wgt. (lbs) 168	<b>DN7230SAESD</b> Wgt. (lbs) 168

Base Part NO./ Size	Plastic Laminate	ESD Laminate
<b>DN4830DS</b> 48"L x 30"W <b>Double Starter</b>	<b>DN4830DSPL</b> Wgt. (lbs) 280	<b>DN4830DSESD</b> Wgt. (lbs) 280
<b>DN6030DS</b> 60"L x 30"W <b>Double Starter</b>	<b>DN6030DSPL</b> Wgt. (lbs) 307	<b>DN6030DSESD</b> Wgt. (lbs) 307
<b>DN7230DS</b> 72"L x 30"W <b>Double Starter</b>	<b>DN7230DSPL</b> Wgt. (lbs) 360	<b>DN7230DSESD</b> Wgt. (lbs) 360
<b>DN4830DA</b> 48"L x 30"W <b>Double Add-On</b>	<b>DN4830DAPL</b> Wgt. (lbs) 220	<b>DN4830DAESD</b> Wgt. (lbs) 220
<b>DN6030DA</b> 60"L x 30"W <b>Double Add-On</b>	<b>DN6030DAPL</b> Wgt. (lbs) 260	<b>DN6030DAESD</b> Wgt. (lbs) 260
<b>DN7230DA</b> 72"L x 30"W <b>Double Add-On</b>	<b>DN7230DAPL</b> Wgt. (lbs) 300	<b>DN7230DAESD</b> Wgt. (lbs) 300





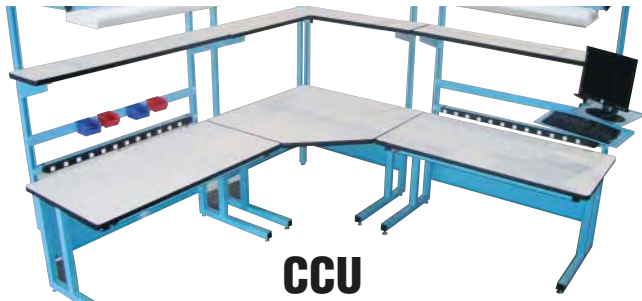

**CCU**

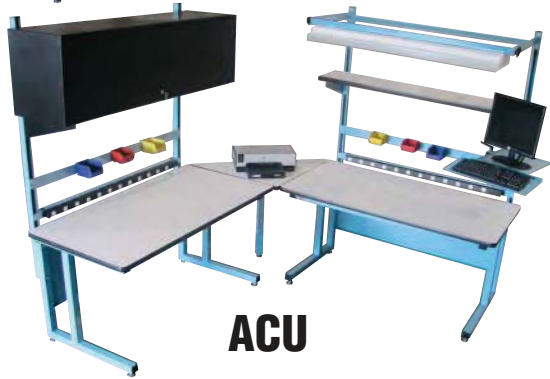

**ACU**

## CORNER UNITS

Need to set up your work stations in an "L" shape configuration?

Pro-Line's work stations are easily configured to meet your layout as illustrated in these photographs. With two corner units to choose from. The ACU aisle corner unit is designed to set corner units on an aisle. This triangular piece comes complete with mounting hardware and supports. The CCU corner unit is a free standing unit designed to set in corners. Just slide two stations up to it and you have an "L" shape.

Surfaces priced with "T" mold edges. Additional charges apply for self edge.

PART NO.	DESCRIPTION	PLASTIC LAMINATE		E.S.D.	
		Wgt. lbs	Wgt. Cap	Wgt. lbs	Wgt. Cap
ACU30	Corner Unit for a 30" Deep Station	<b>ACU30PL</b>		<b>ACU30ESD</b>	
		22	150	22	150
ACU36	Corner Unit for a 36" Deep Station	<b>ACU36PL</b>		<b>ACU36ESD</b>	
		28	150	28	150
CCU30	Free Standing Corner Unit for a 30" Deep Station	<b>CCU30PL</b>		<b>CCU30ESD</b>	
		78	750	78	750
CCU36	Free Standing Corner Unit for a 36" Deep Station	<b>CCU36PL</b>		<b>CCU36ESD</b>	
		88	750	88	750

### "L" Shaped Workbenches, Fixed and Height adjustable.

Built on the models EL and CHD "L" shaped benches are ideal for both office and industry. Height adjustable unit comes with three post hydraulic system. Rear surface depth is 30", side surface is 24" deep. (Pro-line's standard 72" long options mount to the "L" units.)



**ELL7272**



**CHDL7272**



## "L" SHAPED UNITS

PART NO.	DESCRIPTION	PLASTIC LAMINATE		E.S.D.	
		Wgt. lbs.	Wgt. Cap.	Wgt. lbs.	Wgt. Cap.
ELL7272	72" Long x 72" Long	<b>ELL7230PL</b>		<b>ELL7230ESD</b>	
	Unit adjusts from 30" to 42" Surface is two pieces	205	600	205	600
CHDL7272	72" Long x 72" Long	<b>CHDL7230PL</b>		<b>CHDL7230ESD</b>	
	Fixed Height 30" High Surface is two pieces	205	750	205	750

PART NO.	PLASTIC LAMINATE	E.S.D. LAMINATE
	Wgt. lbs	Wgt. lbs
<b>CCUCSPL12</b>	<b>CCUCSPL12PL</b>	<b>CCUCSPL12ESD</b>
	48"Lx48"Lx12"W	41
<b>CCUCSPL18</b>	<b>CCUCSPL18PL</b>	<b>CCUCSPL18ESD</b>
	48"Lx48"Lx18"W	48

## CORNER SHELVES for the CCU30 and CCU36

Corner shelf units are available for both the CCU30 and CCU36. Shelves are 12" or 18" deep. Price includes mounting bracket and hardware.



**Note:** 2 pair of uprights are required per corner unit



# NEW TO THE STOCK PROGRAM 'THE BASICS' 60" & 72" IN STOCK

The Basics is similar in design to our Flexline system. The accessory uprights are included in the base station and the work surface adjusts from 30" to 36" high on 1" increments. From floor to top of frame is 65" high. The Basics station and frame bolt together to keep freight cost down and to minimize storage space when not in use. The Basics is available as a single sided stand alone station or a double sided stand alone station. To help keep cost down, add on stations are available for both the single sided and double sided stations.

Single Sided stations come complete with frame, two top supports, two horizontal leg supports and one worksurface.

Double Sided stations come complete with frame, four top supports, four horizontal leg supports and two worksurfaces.

Add on stations share a top support and a horizontal leg.

## IN STOCK COLORS

- Frames are painted with a durable circuit blue powder coat. (Standard color for the Basics Model).
- Options are painted with a durable textured black powder coat.

BASE PART NO./SIZE	Plastic Laminate	ESD Laminate	IN STOCK	QS
<b>B4830SS</b> 48"L x 30"W <b>Single Starter</b>	<b>B4830SSPL</b> Wgt. (lbs) 110	<b>B4830SSESD</b> Wgt. (lbs) 110		
<b>B6030SS</b> 60"L x 30"W <b>Single Starter</b>	<b>B6030SSPL</b> Wgt. (lbs) 140	<b>B6030SSESD</b> Wgt. (lbs) 140	IN STOCK	QS
<b>B7230SS</b> 72"L x 30"W <b>Single Starter</b>	<b>B7230SSPL</b> Wgt. (lbs) 170	<b>B7230SSESD</b> Wgt. (lbs) 170		QS
<b>B4830SA</b> 48"L x 30"W <b>Single Add On</b>	<b>B4830SAPL</b> Wgt. (lbs) 100	<b>B4830SAESD</b> Wgt. (lbs) 100	IN STOCK	
<b>B6030SA</b> 60"L x 30"W <b>Single Add On</b>	<b>B6030SAPL</b> Wgt. (lbs) 130	<b>B6030SAESD</b> Wgt. (lbs) 130		QS
<b>B7230SA</b> 72"L x 30"W <b>Single Add On</b>	<b>B7230SAPL</b> Wgt. (lbs) 160	<b>B7230SAESD</b> Wgt. (lbs) 160	IN STOCK	QS

BASE PART NO./SIZE	Plastic Laminate	ESD Laminate	IN STOCK	QS
<b>B4830DS</b> 48"L x 30"W <b>Double Starter</b>	<b>B4830DSPL</b> Wgt. (lbs) 219	<b>B4830DSESD</b> Wgt. (lbs) 219		
<b>B6030DS</b> 60"L x 30"W <b>Double Starter</b>	<b>B6030DSPL</b> Wgt. (lbs) 269	<b>B6030DSESD</b> Wgt. (lbs) 269	IN STOCK	QS
<b>B7230DS</b> 72"L x 30"W <b>Double Starter</b>	<b>B7230DSPL</b> Wgt. (lbs) 319	<b>B7230DSESD</b> Wgt. (lbs) 319		QS
<b>B4830DA</b> 48"L x 30"W <b>Double Add On</b>	<b>B4830DAPL</b> Wgt. (lbs) 179	<b>B4830DAESD</b> Wgt. (lbs) 179	IN STOCK	
<b>B6030DA</b> 60"L x 30"W <b>Double Add On</b>	<b>B6030DAPL</b> Wgt. (lbs) 229	<b>B6030DAESD</b> Wgt. (lbs) 229		QS
<b>B7230DA</b> 72"L x 30"W <b>Double Add On</b>	<b>B7230DAPL</b> Wgt. (lbs) 279	<b>B7230DAESD</b> Wgt. (lbs) 279	IN STOCK	QS



Options unique to the Basics Station.

The modular accessories shown with the Basics station are unique to this model.

When ordering optional accessories shown, please use graph to the right.

**For power supply or other optional accessories shown in our catalog, please use the suffix FL at the end of the part number.**

**Example: ESMR48FL for a 48" long Electrical Strip mounting rail.**

PART NO.	DESCRIPTION	Wgt. (lbs)
<b>BOLF48</b>	Over head dual bulb light and frame for 48" L Basics.	28
<b>BOLF60</b>	Over head dual bulb light and frame for 60" L Basics.	30
<b>BOLF72</b>	Over head dual bulb light and frame for 72" L Basics.	32
<b>BMCS1248</b>	Metal Cantilever Shelf 12"D x 48"L For 48" Basics.	22
<b>BMCS1260</b>	Metal Cantilever Shelf 12"D x 60"L For 60" Basics.	27
<b>BMCS1272</b>	Metal Cantilever Shelf 12"D x 72"L For 72" Basics.	32
<b>BBH48</b>	Parts Bin Holder for a 48"L Basics.	10
<b>BBH60</b>	Parts Bin Holder for a 60"L Basics.	13
<b>BBH72</b>	Parts Bin Holder for a 72"L Basics.	16





## NEW TO THE STOCK PROGRAM 'THE BASICS' 60" & 72" IN STOCK



**STARTER AND ADD-ON WITH  
OPTIONAL ACCESSORIES**



**DOUBLE SIDED STARTER DOUBLE SIDED  
ADD-ON CONFIGURED IN A "QUAD"**



**SHOWN WITH BCCU30  
CORNER UNITS**

## WIRE HARNESS ASSEMBLY STATIONS

The MWH and the EWH models are designed for the ergonomic assembly of wire harnesses. Both models feature a 72" long x 36" wide platform capable of holding boards from 24" wide x 24" long up to 48" wide x 96" long. Both models incorporate an adjustable front guardrail that captivates boards from .250" to .750" thick. The EWH features a 60 degree electric foot pedal operated tilt with 600 pounds capacity. When the EWH is fully tilted, the front edge of board adjusts from 24.5" to 40.5" high via foot pedal operation. The MWH features a 13 position manual 60 degree tilt and 150 pound capacity. When the MWH is fully tilted, the front edge of the board adjusts from 24" to 36" via hand crank.



**EWH 7236**



**MWH 7236**

PART NO.	DESCRIPTION	Wgt. (lbs)
<b>MWH7236</b> 72"Lx36"W	Wire harness table with a 72"L x 36" W platform to hold wire harness assembly boards. With hand crank height adjustment and manual tilt.	240
<b>EWH7236</b> 72"Lx36"W	Wire harness table with a 72"L x 36" W platform to hold wire harness assembly boards. With electric height adjustment and electric tilt.	327

## THE EST EXHAUST STATION

Standard height 30.5 to 46.5 high

## EXHAUST STATIONS

BASE PART NO./SIZE	HDPE	ESD
<b>EST4830</b> 48"L x 30"W	<b>EST4830HDPE</b> Wgt (lbs) 295	<b>EST4830ESD</b> Wgt (lbs) 295
<b>EST4836</b> 48"L x 36"W	<b>EST4836HDPE</b> Wgt (lbs) 301	<b>EST4836ESD</b> Wgt (lbs) 301
<b>EST6030</b> 60"L x 30"W	<b>EST6030HDPE</b> Wgt (lbs) 325	<b>EST6030ESD</b> Wgt (lbs) 325
<b>EST6036</b> 60"L x 36"W	<b>EST6036HDPE</b> Wgt (lbs) 285	<b>EST6036ESD</b> Wgt (lbs) 285
<b>EST7230</b> 72"L x 30"W	<b>EST7230HDPE</b> Wgt (lbs) 341	<b>EST7230ESD</b> Wgt (lbs) 341
<b>EST7236</b> 72"L x 36"W	<b>EST7236HDPE</b> Wgt (lbs) 361	<b>EST7236ESD</b> Wgt (lbs) 361

BASE WORKSTATIONS



Perfect for grinding or soldering

Option can be mounted on any base model

The **EST Model** station is designed to be connected to your "inhouse" exhaust system. Shown with the HDPE surface perforated on 1" centers with catch pan below with 4" diameter connection pipe on the bottom. Built on the MVSII electric height adjustable station with programmable memory and featuring the ET-1 electric tilt.

## WELDING TABLES



PART NO.	.250 STEEL WORK SURFACE	Wgt. (lbs)
<b>W/HD/ST4830</b>	48"L x 30"W	135
<b>W/HD/ST4836</b>	48"L x 36"W	155
<b>W/HD/ST6030</b>	60"L x 30"W	165
<b>W/HD/ST6036</b>	60"L x 36"W	190
<b>W/HD/ST7230</b>	72"L x 30"W	195
<b>W/HD/ST7236</b>	72"L x 36"W	225
<b>W/HD/ST9630</b>	96"L x 30"W	250
<b>W/HD/ST9636</b>	96"L x 36"W	290

48"H STEEL BACKSTOP WITH UPRIGHTS
<b>WST48</b> 48"L Wgt (lbs) 135
<b>WST60</b> 60"L Wgt (lbs) 155
<b>WST72</b> 72"L Wgt (lbs) 175
<b>WST96</b> 96"L Wgt (lbs) 224

96" Long station shown with 6 leg design  
Stations up to 72" long are 4 leg design

The **Model W/HD/ST** welding bench built on the Model HD frame has been in use since 1979. Unpainted .250" thick steel surface gives you a solid flat surface to weld on. Optional back stop blocks arc flash and helps contain spark. (Standard height 30" high). 2000 pound capacity.

**SECTION II**

**PACKAGING / MAILROOM WORKSTATIONS**

**PACKAGING WORKSTATIONS**

PACKAGING  
MAILROOM  
WORKSTATIONS



Proline's Packaging Work Benches are sold complete with all accessories shown. Features include full lower shelf with four 18"x18" dividers, full width upper frame storage shelf with 4" of clearance, UR72 uprights, bin holder, 6 outlet power supply, paper spool holder, 12" packbench cantilever shelf with backstop, four 4" dividers, corrugated storage shelf with four 12"x18" dividers and a shop light with a T-8 ballast

ESD price includes a ground kit. **Bench height is adjustable from 30" to 36".** 750 lbs. capacity.

**In Stock Light Gray only**  
**For other colors, see Inside back cover.**  
**Additional charges may apply**

**"In Stock and ready to ship within 5 business days."**

***"THE COMPLETE PACK BENCH"***

BASE PART NO./SIZE	PLASTIC LAMINATE		E.S.D.		SOLID MAPLE	
<b>CPB6030</b>	<b>CPB6030PL</b>		<b>CPB6030ESD</b>		<b>CPB6030SM</b>	
60"Lx30"W	Wgt. lbs 325	Wgt. Cap 750	Wgt. lbs 325	Wgt. Cap 750	Wgt. lbs 362	Wgt. Cap 750
<b>CPB7230</b>	<b>CPB7230PL</b>		<b>CPB7230ESD</b>		<b>CPB7230SM</b>	
72"Lx30"W	Wgt. lbs 355	Wgt. Cap 750	Wgt. lbs 355	Wgt. Cap 750	Wgt. lbs 399	Wgt. Cap 750

**ROTARY SHEAR CUTTER**

For cutting all types of thick packing materials. Mounts to any station. Cutter slides left to right.



PART NO.	DESCRIPTION	Cut Width	Wgt. (lbs)	Wgt. (cap)
<b>RSC36</b>	For 5' Bench 51"L	up to 36"	11	N/A
<b>RSC48</b>	For 6' Bench 63" L	up to 48"	12	N/A
<b>RSC60</b>	For 8' Bench 75"L	up to 60"	15	N/A
<b>RB</b>	Replacement Blade	N/A	1	N/A

## PACKAGING WORKSTATIONS

BASE PART NO./SIZE (Indicate Custom Height)	PLASTIC LAMINATE		E.S.D. LAMINATE		SOLID 1 1/4" MAPLE	
<b>PB7230</b> "Hgt	<b>PB7230PL</b>		<b>PB7230ESD</b>		<b>PB7230SM</b>	
72"L x 30"W	Wgt. (lbs) 255	Wgt. (cap) 1000	Wgt. (lbs) 255	Wgt. (cap) 1000	Wgt. (lbs) 292	Wgt. (cap) 1000
<b>PB7236</b> "Hgt	<b>PB7236PL</b>		<b>PB7236ESD</b>		<b>PB7236SM</b>	
72"L x 36"W	Wgt. (lbs) 265	Wgt. (cap) 1000	Wgt. (lbs) 265	Wgt. (cap) 1000	Wgt. (lbs) 309	Wgt. (cap) 1000



### MODULAR ACCESSORIES INCLUDED IN PB SERIES

PART NO.	DESCRIPTION	Wgt. (lbs)
<b>HDLE-6</b>	6" Leg Extenders	8
<b>UR60</b>	Accessory Upright Supports	7
<b>PSH72</b>	Paper Spool Holder 72"	5.91
<b>USPSH72</b>	Under Surface Spool Holder	6.5
<b>MA-1</b>	Articulating Monitor Arm	19
<b>PBAMS1272</b>	Adjustable Metal Shelf	32.5
<b>1212DIV</b>	12" x 12" Steel Dividers	2
<b>EMCS1272</b>	Enclosed Metal Shelf	42
<b>RSC36</b>	Rotary Shear Cutter	11

## ERGONOMIC HEIGHT ADJUSTABLE PACKAGING WORKSTATIONS

BASE PART NO./SIZE	PLASTIC LAMINATE	ESD LAMINATE	SOLID MAPLE
<b>ELHCPB4830</b> 48"L x 30"W	<b>ELHCPB4830PL</b> Wgt (lbs) 375	<b>ELHCPB4830ESD</b> Wgt (lbs) 375	<b>ELHCPB4830SM</b> Wgt (lbs) 399
<b>ELHCPB4836</b> 48"L x 36"W	<b>ELHCPB4836PL</b> Wgt (lbs) 400	<b>ELHCPB4836ESD</b> Wgt (lbs) 400	<b>ELHCPB4836SM</b> Wgt (lbs) 424
<b>ELHCPB6030</b> 60"L x 30"W	<b>ELHCPB6030PL</b> Wgt (lbs) 430	<b>ELHCPB6030ESD</b> Wgt (lbs) 430	<b>ELHCPB6030SM</b> Wgt (lbs) 467
<b>ELHCPB6036</b> 60"L x 36"W	<b>ELHCPB6036PL</b> Wgt (lbs) 435	<b>ELHCPB6036ESD</b> Wgt (lbs) 435	<b>ELHCPB6036SM</b> Wgt (lbs) 472
<b>ELHCPB7230</b> 72"L x 30"W	<b>ELHCPB7230PL</b> Wgt (lbs) 435	<b>ELHCPB7230ESD</b> Wgt (lbs) 435	<b>ELHCPB7230SM</b> Wgt (lbs) 482
<b>ELHCPB7236</b> 72"L x 36"W	<b>ELHCPB7236PL</b> Wgt (lbs) 455	<b>ELHCPB7236ESD</b> Wgt (lbs) 455	<b>ELHCPB7236SM</b> Wgt (lbs) 499

For Electric Height Adjustment, change prefix to ELHECPB

Pro-Line's PB Model Packaging Workstations can be purchased complete with all accessories shown or remove those accessories not necessary for your application. It's easy with our modular design. 5000 lbs. capacity.

Standard height 30" to 36".

### SCALE STAND

Scale stands come complete with a plastic laminate worksurface and a set of HDLE-6 that makes unit adjustable from 24"H to 30"H.

PART NO.	DESCRIPTION	Wgt. (lbs)
<b>SCS2424</b>	Scale Stand 24"W x 24"L	46
<b>SCS3030</b>	Scale Stand 30"W x 30"L	65

### CARDBOARD STORAGE STAND

Cardboard stand is 24"W x 36"L with 5 steel dividers 24"W x 24"H. Painted steel to match workstations.

PART NO.	DESCRIPTION	Wgt. (lbs)
<b>CS2436</b>	Cardboard Stand	75



The **ELHCPB** combines two great Pro-line products, the convenience of our complete packaging station and the sturdy ergonomic design of our four post height adjustable station. The ELHCPB comes complete with a lower shelf, four dividers, uprights, overhead light, power supply with mounting rail, corrugated storage shelf with four dividers, storage shelf with 4" back, bin holder and a paper spool holder. Station also comes complete with four post hand crank hydraulic height adjustment with 750 LB. capacity.

Standard adjustment 30" to 42"

(Optional push button electric adjustable available at additional charge)

**PACKAGING WORK BENCH**

BASE PART NO./SIZE	PLASTIC LAMINATE		SOLID 1¾" MAPLE	
<b>P6030</b> 60"L x 30"W	<b>P6030PL</b>		<b>P6030SM</b>	
	Wgt. (lbs) 210	Wgt. (cap) 5,000	Wgt. (lbs) 240	Wgt. (cap) 5,000
<b>P6036</b> 60"L x 36"W	<b>P6036PL</b>		<b>P6036SM</b>	
	Wgt. (lbs) 220	Wgt. (cap) 5,000	Wgt. (lbs) 257	Wgt. (cap) 5,000
<b>P7230</b> 72"L x 30"W	<b>P7230PL</b>		<b>P7230SM</b>	
	Wgt. (lbs) 225	Wgt. (cap) 5,000	Wgt. (lbs) 273	Wgt. (cap) 5,000
<b>P7236</b> 72"L x 36"W	<b>P7236PL</b>		<b>P7236SM</b>	
	Wgt. (lbs) 235	Wgt. (cap) 5,000	Wgt. (lbs) 257	Wgt. (cap) 5,000
<b>P9630</b> 96"L x 30"W	<b>P9630PL</b>		<b>P9630SM</b>	
	Wgt. (lbs) 293	Wgt. (cap) 5,000	Wgt. (lbs) 342	Wgt. (kgs) 5,000
<b>P9636</b> 96"L x 36"W	<b>P9636PL</b>		<b>P9636SM</b>	
	Wgt. (lbs) 303	Wgt. (cap) 5,000	Wgt. (lbs) 362	Wgt. (cap) 5,000

Pro-Line's Packaging Station comes complete with accessories shown. Paper Roll not included. 1000 lbs. capacity.

Dividers can be sold separately. Each at additional charge.

Standard Height 30" to 36".

Other Heights available at an additional charge



Shown with optional Eco/DS6/HK drawer

PACKAGING MAILROOM WORKSTATIONS

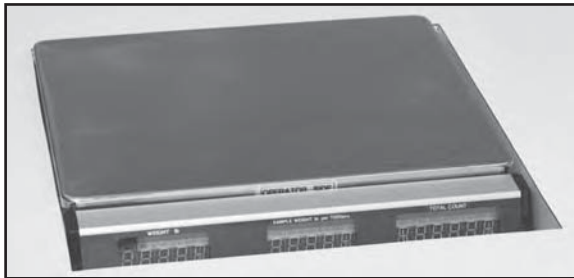

**BUILT IN SCALE SHELF**

Set your scale flush with your work surface. The built in scale shelf eliminates lifting products to weigh them—you just slide the product on the scale. Fits scales 12" x 12" x 2.65". For other sizes please consult factory. (Must be ordered at time of workstation purchase) 100 lbs. Capacity. Scale not included. **Please specify mounting location.**

PART NO.	DESCRIPTION	WGT. (LBS)
<b>BISS1212</b>	Scale Shelf 12.75" x 12.75" x 2.650"	10

**PACK STAND**

Free Standing packaging stand for easy handling and cutting of packaging material. Available as a single sided unit or a double sided unit. Shown as a double sided unit.

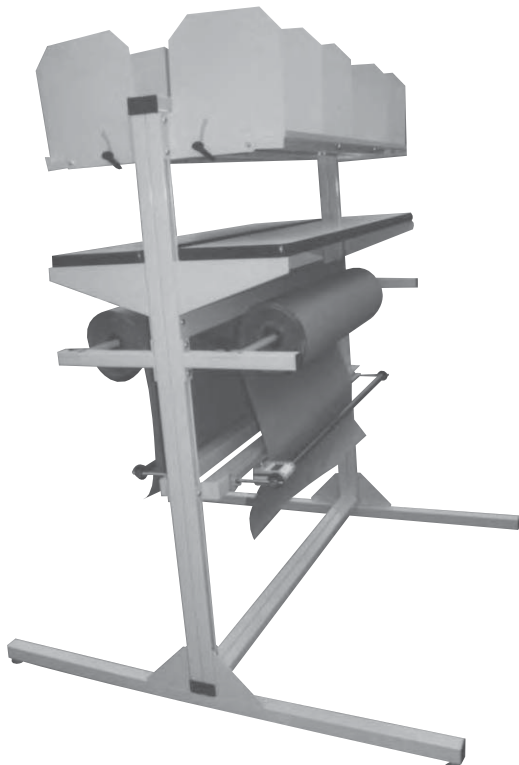

PART NO.	DESCRIPTION	Wgt. (lbs)
<b>SPS6066</b>	Single Sided 60"L x 66"H	106
<b>DPS6066</b>	Double Sided 60"L x 66"H	191

**PAPER CUTTER**

Holds 36"L rolls of paper

PART NO.	DESCRIPTION	Wgt. (lbs)
<b>PHC36</b>	38"L x 7"W x 8"H	5

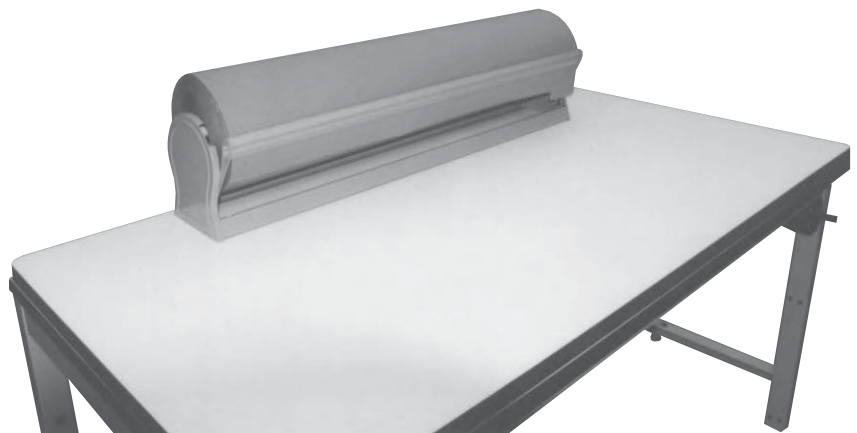

# MAIL ROOM SORTERS

Mount on any Basic Model

## BASE WORKSTATIONS NOT INCLUDED

These versatile above-bench units provide an economical and efficient way to store, sort, and organize a variety of materials. Designed with flexibility and maximum space utilization in mind, these sturdy organizers are easily reconfigured as your needs change.

### 30-BIN HORIZONTAL SORTER

Shown in photo to left.

#ZS-6815-30, 68"L x 15"D x 18"H with enclosed back. Vertical separators welded in place. Order Dividers separately #ZSH-1511, 24 Dividers form 30 bin slots.

### MODEL HD723030 SHOWN WITH 13" RISER AND HORIZONTAL SORTER



### VERTICAL SORTER

#ZVS-6815, 68"W x 15"D x 18"H, 1.625" divider slot spacing. Order dividers separately #ZVD-15. Ideal for storing binders, repair manuals or catalogs.



### 30-BIN PASS THRU SORTER

#ZTS-6815-30, 68"W x 15"D x 18"H, open back design allows access from both sides. Vertical separators welded in place. Order dividers separately #ZTSH-1511, 24 dividers create 30 bin slots.

Horizontal Sorter shown with optional security doors. Order doors separately. #ZPLD-11. Clear plexiglass with lock. Secure 1, 2, up to 6 openings.

**Doors must be ordered at time of sorter order (not field installable).**



Example of how units stack —You create your own system!

PART NO.	DESCRIPTION	Wgt. (lbs)
ZS-6815-30	Horizontal Sorter 68"W x 15"D x 18"H	73
ZTS-6815-30	Pass Thru Sorter 68"W x 15"D x 18"H	77
ZVS-6815	Vertical Sorter 68"W x 15"D x 18"H	79
ZSH-1511	Horizontal Divider	1.6
ZVD-15	Vertical Divider	1.6
ZTSH-1511	Horizontal Pass thru Divider	1.6
ZR-6815-6	6" Closed Back Riser 68"L x 15"D x 6"H	28
ZR-6815-13	13" Closed Back Riser 68"L x 15"D x 13"H	38
ZTR-6815-6	6" Open Back Riser 68"L x 15"D x 6"H	22
ZTR-6815-13	13" Open Back Riser 68"L x 15"D x 13"H	29
ZPLD-11	Door (each door secures 1 opening)	2

# SECTION III

# L.A.N. / COMPUTER STATIONS

Proline offers several models of LAN stations. These stations are designed to meet all your LAN needs. Incorporating our modular design these stations are flexible, ergonomic and affordable.

The LNFL model is built on our FlexLine series. It is available in 24", 30" and 48" lengths. These units are easily bolted together to allow you to configure the ideal LAN station for your application. The part number LNFL includes an open frame 80" high, a 30" deep work surface and two horizontal and vertical leg supports. You add the accessories to meet your requirements. Work surface adjusts from 30" to 36".

L.A.N. COMPUTER STATIONS

PART NO.	PLASTIC LAMINATE		E.S.D.	
<b>LNFL243080</b>	<b>LNFL243080PL</b>		<b>LNFL243080ESD</b>	
24"Lx30"Wx80"H	Wgt. lbs 120	Wgt. Cap 750	Wgt. lbs 120	Wgt. Cap 750
<b>LNFL303080</b>	<b>LNFL303080PL</b>		<b>LNFL303080ESD</b>	
30"Lx30"Wx80"H	Wgt. lbs 128	Wgt. Cap 750	Wgt. lbs 128	Wgt. Cap 750
<b>LNFL483080</b>	<b>LNFL483080PL</b>		<b>LNFL483080ESD</b>	
48"Lx30"Wx80"H	Wgt. lbs 138	Wgt. Cap 750	Wgt. lbs 138	Wgt. Cap 750

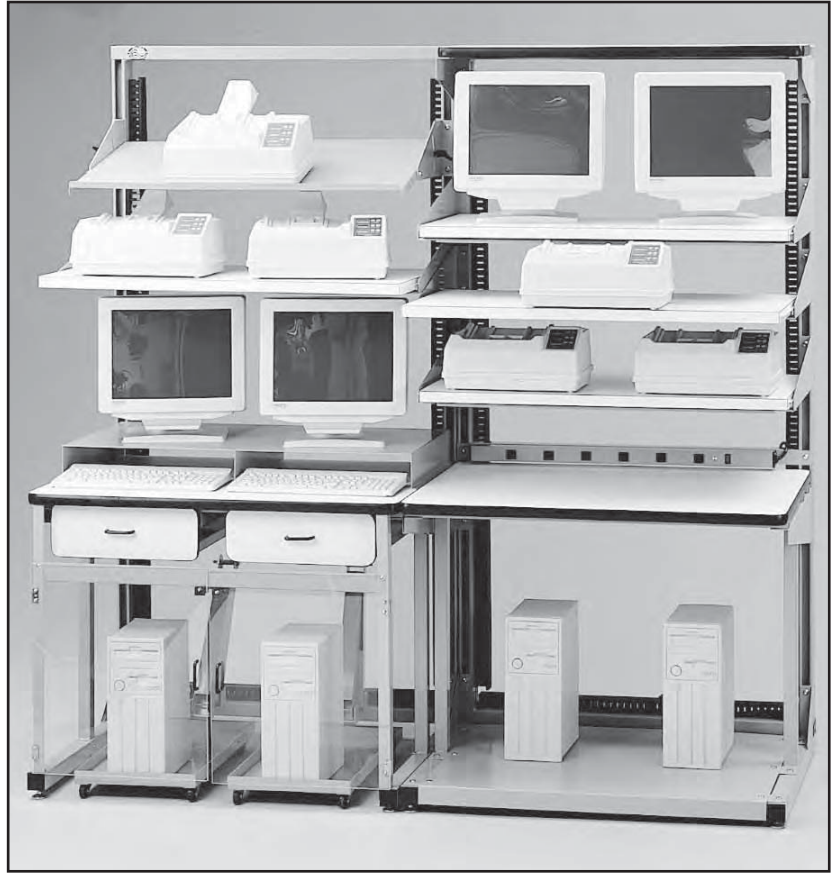

PART NO.	DESCRIPTION	WGT. (LBS)
<b>WMS1.5</b>	1.5"x1.5" Wire Management 72" long Specify length and and location at time of order	3
<b>POPS2420F</b>	Pull Out Printer Shelf 24"Lx20"D	20
<b>POPS3020F</b>	Pull Out Printer Shelf 30"Lx20"D	24
<b>POPS4820F</b>	Pull Out Printer Shelf 48"Lx20"D	28
<b>MSR2420</b>	Monitor Riser Shelf Steel 24"Lx20"D (single)	32
<b>MSR3020</b>	Monitor Riser Shelf Steel 30"Lx20"D (single)	38
<b>MSR4820</b>	Monitor Riser Shelf Steel 48"Lx20"D (double)	43
<b>AMS2424FL</b>	Adjustable Metal Shelf 24"Lx24"W Steel 90 Degree to 30 Degree	26
<b>AMS3024FL</b>	Adjustable Metal Shelf 30"Lx24"W Steel 90 Degree to 30 Degree	29
<b>AMS4824FL</b>	Adjustable Metal Shelf 48"Lx24"W Steel 90 Degree to 30 Degree	32
<b>ESMR24FL</b>	Electrical Supply Mounting Rail for 24"L flexline	1.75

PART NO.	DESCRIPTION	WGT. (LBS)
<b>ESMR30FL</b>	Electrical Supply Mounting Rail for 30" flexline	2.75
<b>ESMR48FL</b>	Electrical Supply Mounting Rail for 48" flexline	3.25
<b>ES12</b>	6 Outlet Power Supply Mounts to ESMR24 and 30	1.75
<b>ES36</b>	9 Outlet Power Supply Mounts to ESMR48	3.5
<b>LNLS24FL</b>	LAN Station Lower Shelf Steel. Includes three braces for heavy loads. 24"Lx30"D	24
<b>LNLS30FL</b>	LAN Station Lower Shelf Steel. Includes three braces for heavy loads. 30"Lx30"D	27
<b>LNLS48FL</b>	LAN Station Lower Shelf Steel. Includes three braces for heavy loads. 48"Lx30"D	30
<b>PCPTF</b>	Pull Out CPU Trays. Includes Articulating Wire Management 13 13/16" W x 23 7/8" L	32
<b>PLGD</b>	Plexiglass Doors. Protects CPU. Add 24, 30, 48 to part number to specify length.	23
<b>MDS6</b>	6" Modular Drawer	26

## LNFL



## LNFL

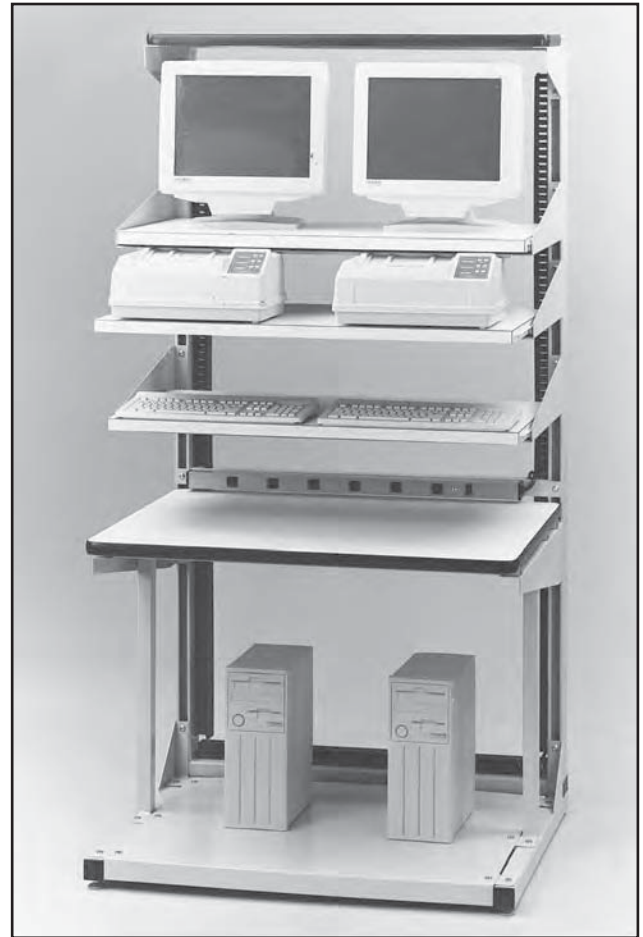

L.  
A.  
N.  
C  
O  
M  
P  
U  
T  
E  
R  
S  
T  
A  
T  
I  
O  
N  
S

## LNHD

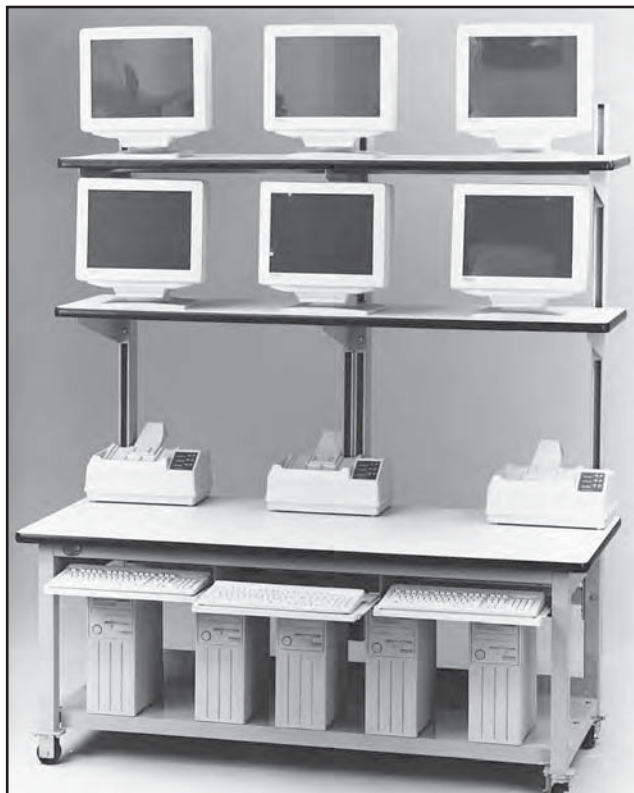

## LNHD

The LNHD is designed from our popular HD model. The model shown is 72"Lx30"Dx94"H to top of upright. Features on this model include a set of plate casters (two swivel with brake two rigid), full width lower shelf, three pull out keyboard trays, split upright system with four double uprights extending 60" above the surface and two cantilever shelves 18" deep x 72" long. With Pro-Line's modular design it's easy to configure the LAN station you need.

**18" clearance from shelf to underside of keyboard tray.**

**Worksurface Height is 30"**

PART NO.	PLASTIC LAMINATE		E.S.D.	
<b>LNHD7230</b>	<b>LNHD7230PL</b>		<b>LNHD7230ESD</b>	
72"Lx30"Wx94"H	Wgt. lbs 353	Wgt. Cap 1000	Wgt. lbs 353	Wgt. Cap 1000



# COMPUTER TABLES

Pro-Line has taken our basic concept of a sturdy and economical design and incorporated it into these computer tables. The "CT" model is a cantilever design that is 48"L x 36"D x 30"H. Features include a steel modesty panel and a 90 degree rolled front edge. The "ECT" is an electric height adjustable computer station. With the smooth operating electric motor the unit quickly adjusts from 32" to 51.625" high. The "ECT" has a 250 pound capacity.

**Tubular Risers sold seperately**



Base Part No./Size	PLASTIC LAMINATE		E.S.D.	
<b>CT4836</b>	<b>CT4836PL</b>		<b>CT4836ESD</b>	
48"Lx36"W	Wgt. lbs 110	Wgt. Cap 500	Wgt. lbs 110	Wgt. Cap 500
<b>ECT3030</b>	<b>ECT3030PL</b>		<b>ECT3030ESD</b>	
30"Lx30"W	Wgt. lbs 95	Wgt. Cap 250	Wgt. lbs 95	Wgt. Cap 250
<b>ECT3636</b>	<b>ECT3636PL</b>		<b>ECT3636ESD</b>	
36"Lx36"W	Wgt. lbs 115	Wgt. Cap 250	Wgt. lbs 115	Wgt. Cap 250

L. A. N. COMPUTER STATIONS

## CPU HOLDER



**Pull out and swivel CPU holder 75 lbs. capacity**

PART NO.	DESCRIPTION	WGT. (LBS)
<b>PRO-18785</b>	Pull Out CPU Holder	9



Black finish with a 360° swivel.  
Adjustable strap fits up to 65" perimeter.

**Mounts under any Pro-Line station.  
Please specify model to be mounted  
to when ordering**

## FLAT SCREEN MONITOR ARM

**See page 38**



## KEYBOARD TRAYS

Neatly and ergonomically store your keyboard. Both models slide under the work surface. Both models feature an adjustable clamp to fit any size keyboard. The "KBT" includes a black ABS plastic arm rest. The "DKBT" features a soft polyethylene foam pad with black vinyl upholstery. The "DKBT" is also height adjustable. The "KBT" has an optional mouse pad. The mouse pad for the "DKBT" adjusts with the keyboard.

OPTIONAL ACCESSORIES		
PART NO.	DESCRIPTION	WGT. (LBS)
<b>KBT</b>	Sliding Keyboard Tray with arm rest	6
<b>MP</b>	Mouse pad for the KBT	3
<b>DKBT/DMP</b>	Sliding Keyboard Tray, Delux mouse pad, with arm rest and height adjust	16



**These keyboards can be mounted to all our models.  
CPU and Keyboards include hanging kit.**



# SECTION IV

# ACCESSORIES

**NOTE:** When ordering accessories only, please indicate the model they are mounting to.  
**Example:** For a shelf with a Flexline Station use CSPL1260PL FL.

## UPRIGHTS

Universal Uprights accept all accessories which would be suspended above work surface. Features infinite adjustability and self tightening hardware. Complete with mounting hardware. Priced per pair.

PART NO.	DESCRIPTION	Wgt. (lbs)
<b>UR24</b>	Uprights 24"/60.96cm (12" Above Surface)	8
<b>UR36</b>	Uprights 36"/91.44cm (24" Above Surface)	10
<b>UR48</b>	Uprights 48"/121.92cm (36" Above Surface)	15
<b>UR60</b>	Uprights 60"/152.40cm (48" Above Surface)	20
<b>UR72</b>	Uprights 72"/182.82cm (60" Above Surface)	25

UR 72 only are 3.25" Thick.  
 All others 1.625" as shown



## HEAVY DUTY UPRIGHTS

Constructed from the same material as our standard uprights, these uprights are double thick. Designed for placing heavy items on multiple shelves and mounting accessories behind station, chatter shields or a shelf, for example. HDUR60 are 60"L and extend up to 48" above surface. Sold in pairs.

PART NO.	DESCRIPTION	WGT. (LBS)
<b>HDUR60</b>	1.625" x 3.250" x 60" uprights extend 48" above surface.	40

## SPLIT UPRIGHT SYSTEM

Mounts to most Pro-Line Stations. Price includes 4 UR60 and 1 lower upright support. Extends 48" above surface.

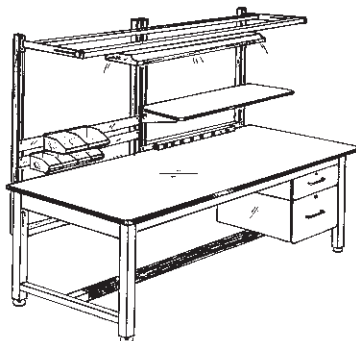

PART NO.	DESCRIPTION	Wgt. (lbs)	Wgt. (cap)
<b>SURS48</b>	Split Upright System for 48" Bench	19.5	8.8
<b>SURS60</b>	Split Upright System for 60" Bench	20.5	9.3
<b>SURS72</b>	Split Upright System for 72" Bench	21.5	9.7
<b>SURS96</b>	Split Upright System for 96" Bench	25	11.3



Note: When ordering accesories for the split upright system, please add /SURS to the part number. For example- ESMR60/SURS

ACCESSORIES

## LOUVERED PANELS (FOR HANGING BINS)

These 34" high louvered panels consist of (2) 17" peices and are steel construction. Panels are painted to match frame.

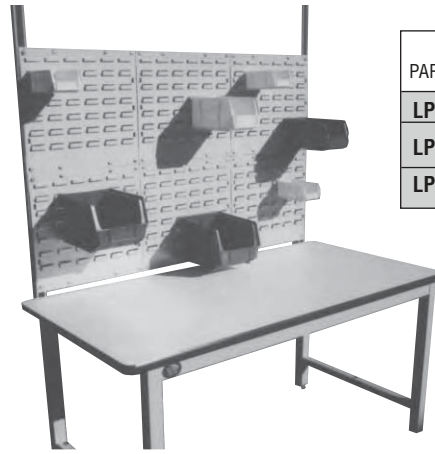

PART NO.	DESCRIPTION	Wgt. (lbs)	Wgt. (cap)
LP4834	Fits 48" Workstation	26	100
LP6034	Fits 60" Workstation	36	150
LP7234	Fits 72" Workstation	48	175

For other sizes,  
Please consult factory



PART NO.	DESCRIPTION	Wgt. (lbs)	Wgt. (cap)
TSF1248	Tool Trolley Frame 12"W 48"L 30.48cm x 121.92cm Projection	12	75
TSF1260	Tool Trolley Frame 12"W 60"L 30.48cm x 152.40cm Projection	13	75
TSF1272	Tool Trolley Frame 12"W 72"L 30.48cm x 182.88cm Projection	14	75
TSF1296	Tool Trolley Frame 12"W 96"L 30.48cm x 243.84cm Projection	16	75

## TOOL SUSPENSION FRAME I

Welded channel frame allows mounting of one or more tools with full length sliding capability. **(Not required if overhead light frame is purchased.)** Tool balancers and torque arms can then be utilized. Price includes 2 Tool Trolleys.



PART NO.	DESCRIPTION	Wgt. (lbs)	Wgt. (cap)
TSF1848	Tool Trolley Frame 18"W 48"L 45.76cm x 121.92cm Projection	13	75
TSF1860	Tool Trolley Frame 18"W 60"L 45.76cm x 152.40cm Projection	14	75
TSF1872	Tool Trolley Frame 18"W 72"L 45.76cm x 182.88cm Projection	15	75
TSF1896	Tool Trolley Frame 18"W 96"L 45.76cm x 243.84cm Projection	17	75

## TOOL SUSPENSION FRAME II

This "Tool Suspension Frame" mounts directly into our "Overhead Light Frame." Tool balancers and torque arms can then be utilized. Tool Frame adjustable back and forward, full extension 24" over surface. Price includes 2 Tool Trolleys. **Extra Trolleys priced seperately. Part# ETT**

PART NO.	DESCRIPTION	Wgt. (lbs)	Wgt. (cap)
LTF48	Fits 48" Bench	12	75
LTF60	Fits 60" Bench	13	75
LTF72	Fits 72" Bench	14	75
LTF96	Fits 96" Bench	16	75

## OVERHEAD LIGHT FRAME

Includes structural steel light mounting frame, (1) dual bulb fluorescent fixture with 9' powercord and on/off switch.

The new 3 way adjustable light allows adjustment of lighting front to back over worksurfaces as well as swivel capability. Comes complete with lock knobs. Rear support also functions as fixed tool balancer slide trolley.

OLF48 Comes standard with a T-8 Ballast, Optional on other lights

**Center of light extrudes up to 24" from back of station. Bulbs not included.**

**For voltage requirements outside USA, additional charges apply. Please specify which country.**

PART NO.	DESCRIPTION	Wgt. (lbs)	Wgt. (kgs)
OLF48	Mounts on 48"L/121.92cm Station	21	9.5
OLF60	Mounts on 60"L/152.40cm Station	27	12.2
OLF72	Mounts on 72"L/182.88cm Station	38	17.2
OLF96	Mounts on 96"L/243.84cm Station	45	20.4



STANDARD FIXTURE

### ADDITIONAL CHARGE FOR DELUXE FIXTURE

ADD LETTER "D" TO PART# FOR DELUXE. ie:OLF60D



**Parabolic lens available on deluxe fixture only, add "P" to part # ie: OLF60DP.**

**Under shelf / Under cabinet lighting  
Part# LT48...See page 57 for example**



Drawer Faces white only

### FOOTREST

Heavy gauge steel painted to match frame – adds greater comfort and less fatigue for the operator. Shown with optional guard (priced on graph below).

PART NO.	DESCRIPTION	Wgt. (lbs)	Wgt. (kgs)
FR48	Fits 48"L/121.92cm Station	5	2.2
FR60	Fits 60"L/152.40cm Station	6¼	2.8
FR72	Fits 72"L/182.88cm Station	7½	3.4
FR96	Fits 96"L/243.84cm Station	10	4.5

### FOOTREST GUARD

Black vinyl cover for the footrest is additional, adds comfort and enhanced appearance.

PART NO.	DESCRIPTION	Wgt. (lbs)	Wgt. (kgs)
FRG48	Vinyl Guard for 48"L/121.92cm Station	4	1.8
FRG60	Vinyl Guard for 60"L/152.40cm Station	5	2.2
FRG72	Vinyl Guard for 72"L/182/99cm Station	6	2.7
FRG96	Vinyl Guard for 96"L/243.84cm Station	8	3.6

### MODULAR DRAWER SYSTEM (TOP QUALITY ROUNDED EDGE MODEL)

Features rounded T mold corners to match top for operator protection at knee level. Modular concept allows independent design for easy configuration throughout plant. Durable steel body with quality T mold edged laminate face, smooth drawer action on ball bearings. Requires one mounting bracket per workstation. Dim. of Drawers 15"W x 19¼"D.

\*PRICE INCLUDES LOCK

When ordering drawers alone, please add model# as suffix Example: HK/EL. Different models require their own hanging kits.

PART NO.	DESCRIPTION	Wgt. (lbs)	Wgt. (kgs)
MDS-3	3"H/7.62cm Drawer Unit	20	9
MDS-6	6"H/16.24cm Drawer Unit	26	11.8
MDS-9	9"H/22.86cm Drawer Unit	32	14.5
MDS-12	12"H/30.48cm Drawer Unit	38	17.2
HK	Drawer Hanging Kit	1.15	.52

HK also required on POWS, KOS, DP-1, and CPU.  
\*All drawers are keyed differently unless specified

### 20 AMP ELECTRICAL SUPPLY (20A, 125V)

Includes 6 or 8 outlets, standard on/off switch, indicator light, resettable circuit breaker and 6' cord. Mounting is identical to our standard electrical supply.

NOTE: Other 20 amp configurations available upon request.

PART NO.	DESCRIPTION	Wgt. (lbs)	Wgt. (kgs)
ES36/20 6 outlets	20 AMP Electrical Supply 36"L/50.80cm x 91.44cm	4¼	1.9
ES48/20 8 outlets	20 AMP Electrical Supply 48"L/50.80cm x 121.96cm	5¼	2.3

### STANDARD ELECTRICAL SUPPLY (15A, 125V)

Includes 12 outlets, on/off switch, on indicator light, resettable circuit breaker, 6' cord, mounts to electrical supply mounting rail (which is fully adjustable on uprights) or to worksurfaces, frame, etc. Electrical supplies punched and wired directly into the workstation frame are available upon request.

NOTE: Pro-Line can match any electrical or other utility specifications you may have.



For 48" Long Stations Use ES36

PART NO.	DESCRIPTION	Wgt. (lbs)	Wgt. (kgs)
ES12	12"L/30.48cm (6) Outlet Powerstrip	1¼	.8
ES36	36"L/91.44cm (9) Outlet Powerstrip	3½	1.5
ES48	48"L/121.92cm (12) Outlet Powerstrip	4½	2

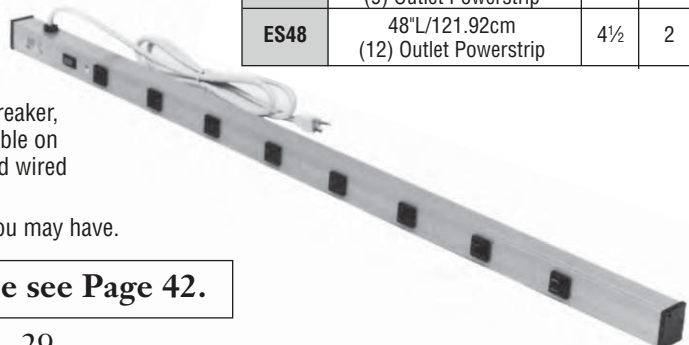

For voltage requirements outside USA, please see Page 42.

## ELECTRICAL SUPPLY MOUNTING RAIL

Heavy gauge formed steel allows electrical supply to mount to upright system. 2 knockouts allow airquick disconnect to be added.

PART NO.	DESCRIPTION	Wgt. (lbs)	Wgt. (kgs)
ESMR24	Fits 24"/60.96cm Upright System	1¼	.8
ESMR30	Fits 30"/76.20cm Upright System	2¾	1.2
ESMR36	Fits 36"/91.44cm Upright System	3	1.3
ESMR48	Fits 48"/121.92cm Upright System	3¾	1.4
ESMR60	Fits 60"/152.40cm Upright System	4	1.8
ESMR72	Fits 72"/182.88cm Upright System	5	2.2
ESMR96	Fits 96"/243.84cm Upright System	7	3.1



## AIRQUICK DISCONNECT

These air fittings easily mount into receptacle at either end of electrical supply mounting rail. Easily accessible yet keeps worksurface clear of hoses when pneumatic tools are in use.

PART NO.	DESCRIPTION	Wgt. (lbs)	Wgt. (kgs)
AQDC	Mounts on ESMR	1½	.6

## LEG EXTENDERS

Formed steel channel sleeves into bottom of each leg to adjust height in 1" increments. Standard size allows 6" of adjustment. **Set of 4.**

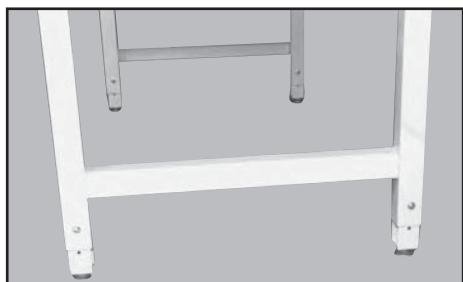

PART NO.	DESCRIPTION	Wgt. (lbs)	Wgt. (kgs)
HDLE-6	6"/15.24cm Leg Adjusters	8	3.6

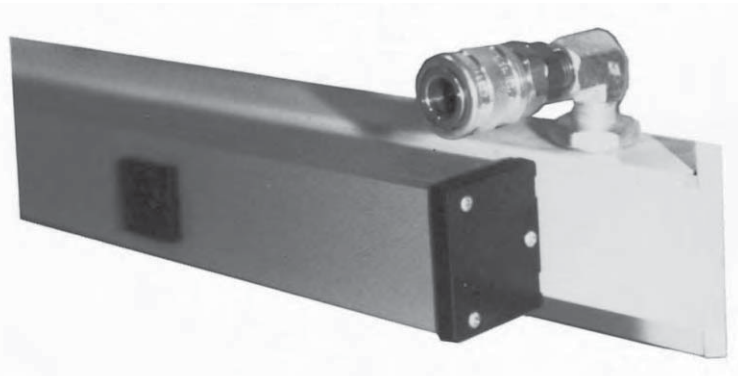

## TOOL BALANCER HOLDER

Mounts to any vertical upright. Channel construction allows tool hook to slide front to back. Standard sizes: TH8" – TH12" – TH18".

Tool balancer hooks onto tool hook.

PART NO.	DESCRIPTION	Wgt. (lbs)	Wgt. (kgs)
TH-8	Mounts to Uprights 8"/20.32cm Projection	2	9.55
TH-12	Mounts to Uprights 12"/30.48cm Projection	3	14.09
TH-18	Mounts to Uprights 18"/45.72cm Projection	4	18.64



## BACK GUARD

3" H guard prevents items from rolling off back of worksurface.

PART NO.	DESCRIPTION	Wgt. (lbs)	Wgt. (kgs)
BSS48	Mounts on Surface 48"L/121.92cm	4½	2
BSS60	Mounts on Surface 60"L/152.40cm	5¾	2.6
BSS72	Mounts on Surface 72"L/182.88cm	7	3.1
BSS96	Mounts on Surface 96"L/243.84cm	9½	4.5

## END GUARD

3"H guard prevents items from rolling off ends of worksurface. Priced per pair.

PART NO.	DESCRIPTION	Wgt. (lbs)	Wgt. (kgs)
ESS24	Mounts on Surface 24"W/60.96cm	2¼	1
ESS30	Mounts on Surface 30"W/76.20cm	3	1.3
ESS36	Mounts on Surface 36"W/91.44cm	3½	1.5



### WIRE SPOOL HOLDER

1" diameter rod holds wire or packaging dispenser spools. Adjustable front to rear

PART NO.	DESCRIPTION	Wgt. (lbs)	Wgt. (kgs)
WSH48	Hold Wire Spool Reels 48"L/121.92cm	11	5
WSH60	Holds Wire Spool Reels 60"L/152.40cm	12	5.45
WSH72	Holds Wire Spool Reels 72"L/182.88cm	13	5.91
WSH96	Holds Wire Spool Reels 96"L/243.84cm	15	6.82

Capacity 100 LB.



### PURSE HOLDER

Open back and front storage when security is not required.

PART NO.	DESCRIPTION	Wgt. (lbs)	Wgt. (kgs)
PHB-1	10"W x 18"D x 12"H (Steel) 25.40cm x 45.72cm x 30.48cm	13	5.91

### PURSE HOLDER WITH BACK

Same as above, with back

PART NO.	DESCRIPTION	Wgt. (lbs)	Wgt. (kgs)
PHB-2	10"W x 18"D x 12"H (Steel) 25.40cm x 45.72cm x 30.48cm	15.5	7.05



### SLIDING DOOR CABINET

Sliding Door Cabinets are 14.5" x 13.75" ID. Cabinets come complete with a lock and mounting brackets. They are ideal for manual storage, components, or personal storage. 200 LB. capacity

PART NO.	DESCRIPTION	Wgt. (lbs)
SDC48	Sliding Door Cabinet 48"L	64
SDC60	Sliding Door Cabinet 60"L	80
SDC72	Sliding Door Cabinet 72"L	72

**Note:**  
SDC should be mounted with back to back HDUR. See page 27 or UR72

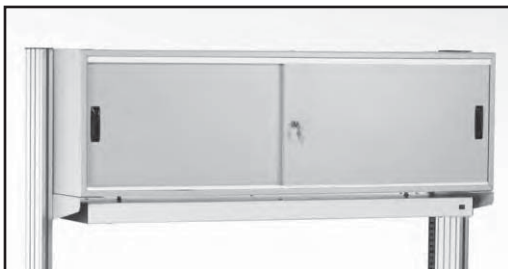

Standard Cabinet supplied with sliding steel doors. Also available with Lexan® sliding doors, glass doors or steel flipper doors  
*\*Textured Paint Only\**  
See page 52 for available Textured colors

### BIN HOLDER

Heavy gauge formed steel mounts to upright system for unlimited adjustment of bins

PART NO.	DESCRIPTION	Wgt. (lbs)	Wgt. (kgs)
BH24	Fits 24"/60.96cm Upright System	2¼	.8
BH30	Fits 30"/76.20cm Upright System	2½	1.1
BH36	Fits 36"/91.44cm Upright System	3½	1.5
BH48	Fits 48"/121.92cm Upright System	4½	2
BH60	Fits 60"/152.40cm Upright System	5½	2.4
BH72	Fits 72"/182.88cm Upright System	6½	2.8
BH96	Fits 96"/243.84cm Upright System	7½	3.2

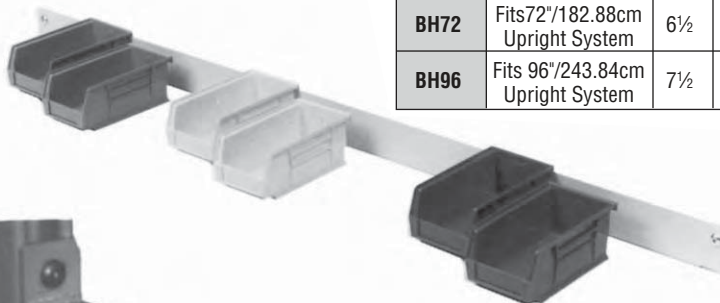

### LAZY SUSAN

18" diameter, 4 position turntable for a wide variety of applications. Other sizes available upon request. 200 lbs capacity. **Min. order 3 units.** 2.53" H.

PART NO.	DESCRIPTION	Wgt. (lbs)	Wgt. (kgs)
LS18-16	Plastic Laminated Turntable 18" Diameter	12	5.45

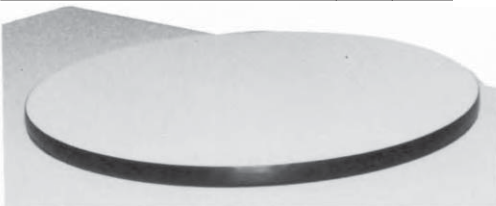

### MAGNIFIER LIGHT BRACKET

Bracket mounts to upright at any height for mounting of magnification lights, document holders, etc.

PART NO.	DESCRIPTION	Wgt. (lbs)	Wgt. (kgs)
LOMB	Mounts to Uprights	1	.4



## MODESTY PANEL (STEEL)

Steel panel painted to match frame. Encloses rear of workstation. 21"H

PART NO.	DESCRIPTION	Wgt. (lbs)	Wgt. (kgs)
MP48	Mounts on 48"L/121.92cm Station	19	8.6
MP60	Mounts on 60"L/152.40cm Station	23½	10.6
MP72	Mounts on 72"L/182.88cm Station	28	12.7
MP96	Mounts on 96"L/243.84cm Station	37½	43.6



## MODESTY PANEL (PLASTIC LAMINATE)

Modesty Panel plastic laminate. Encloses rear of frame. 21"H

PART NO.	DESCRIPTION	Wgt. (lbs)	Wgt. (kgs)
MPP48	Mounts on 48"L/121.92cm Station	15	6.8
MPP60	Mounts on 60"L/152.40cm Station	18¾	8.5
MPP72	Mounts on 72"L/182.88cm Station	22½	10.2
MPP96	Mounts on 96"L/243.84cm Station	30	13.6



## END PANEL (STEEL)

Steel panel painted to match frame. Encloses one or both ends of workstation. Priced each.

PART NO.	DESCRIPTION	Wgt. (lbs)	Wgt. (kgs)
EP24	Mounts on 24"W/60.96cm Station	11	5
EP30	Mounts on 30"W/76.20cm Station	14	6.3
EP36	Mounts on 36"W/91.44cm Station	17	7.7



## END PANEL (PLASTIC LAMINATE)

End Panel plastic laminate. Encloses one or both ends of workstation. Priced each.

PART NO.	DESCRIPTION	Wgt. (lbs)	Wgt. (kgs)
EPP24	Mounts on 24"W/60.96cm Station	10	4.5
EPP30	Mounts on 30"W/76.20cm Station	12½	5.6
EPP36	Mounts on 36"W/91.44cm Station	15	6.8



### CANTILEVER SHELF (PLASTIC LAMINATE)

Includes (1) 12" or 18" wide plastic laminate shelf and shelf supports for each upright – infinitely adjustable. 125 lb capacity per shelf.

BASE PART NO./SIZE	PLASTIC LAMINATE		E.S.D. LAMINATE		SOLID 1¼" MAPLE	
	Wgt. (lbs)	Wgt. (kgs)	Wgt. (lbs)	Wgt. (kgs)	Wgt. (lbs)	Wgt. (kgs)
<b>CSPL1224</b> 12" x 24" (30.4cm x 60.7cm)	<b>CSPL1224PL</b>		<b>CSPL1224ESD</b>		<b>CSPL1224SM</b>	
	12	5.4	12	5.4	12	5.4
<b>CSPL1230</b> 12" x 30" (30.4cm x 76.2cm)	<b>CSPL1230PL</b>		<b>CSPL1230ESD</b>		<b>CSPL1230SM</b>	
	15	6.8	15	6.8	15	6.8
<b>CSPL1236</b> 12" x 36" (30.4cm x 91.4cm)	<b>CSPL1236PL</b>		<b>CSPL1236ESD</b>		<b>CSPL1236SM</b>	
	18	8.1	18	8.1	18	8.1
<b>CSPL1248</b> 12" x 48" (30.4cm x 121.9cm)	<b>CSPL1248PL</b>		<b>CSPL1248ESD</b>		<b>CSPL1248SM</b>	
	24	10.9	24	10.9	24	10.9
<b>CSPL1260</b> 12" x 60" (30.4cm x 152.4cm)	<b>CSPL1260PL</b>		<b>CSPL1260ESD</b>		<b>CSPL1260SM</b>	
	30	13.6	30	13.6	30	13.6
<b>CSPL1272</b> 12" x 72" (30.4cm x 182.8cm)	<b>CSPL1272PL</b>		<b>CSPL1272ESD</b>		<b>CSPL1272SM</b>	
	36	16.3	36	16.3	36	16.3
<b>CSPL1296</b> 12" x 96" (30.4cm x 243.8cm)	<b>CSPL1296PL</b>		<b>CSPL1296ESD</b>		<b>CSPL1296SM</b>	
	42	19	42	19	42	19
<b>CSPL1824</b> 18" x 24" (45.7cm x 76.2cm)	<b>CSPL1824PL</b>		<b>CSPL1824ESD</b>			
	17	7.6	17	7.6		
<b>CSPL1830</b> 18" x 30" (45.7cm x 76.2cm)	<b>CSPL1830PL</b>		<b>CSPL1830ESD</b>			
	22	10.1	22	10.1		
<b>CSPL1836</b> 18" x 36" (45.7cm x 91.4cm)	<b>CSPL1836PL</b>		<b>CSPL1836ESD</b>			
	26	11.9	26	11.9		
<b>CSPL1848</b> 18" x 48" (45.7cm x 121.9cm)	<b>CSPL1848PL</b>		<b>CSPL1848ESD</b>			
	31	13.9	31	13.9		
<b>CSPL1860</b> 18" x 60" (45.7cm x 152cm)	<b>CSPL1860PL</b>		<b>CSPL1860ESD</b>			
	35	16	35	16		
<b>CSPL1872</b> 18" x 72" (45.7 x 182.8cm)	<b>CSPL1872PL</b>		<b>CSPL1872ESD</b>			
	40	18	40	18		
<b>CSPL1896</b> 18" x 96" (45.7cm x 243.8cm)	<b>CSPL1896PL</b>		<b>CSPL1896ESD</b>			
	44	20.1	44	20.1		

PLEASE CONSULT THE FACTORY FOR ALL YOUR CUSTOM FABRICATION REQUIREMENTS

### PLEASE NOTE:

When ordering accessories, the model number that the accessory is mounting to must be indicated.

**Example:** A shelf mounting to a FlexLine station would use a part #CSPL1260PLFL for the 60" Flexline work station.

ACCESSORIES



### ADJUSTABLE METAL SHELF

Rigid steel shelf painted to match frame. Easily adjusts from flat to 30° incline position.

PART NO.	DESCRIPTION	Wgt. (lbs)	Wgt. (cap)
<b>AMS1224</b>	24"W x 12"D	10	70
<b>AMS1230</b>	30"W x 12"D	12.5	70
<b>AMS1236</b>	36"W x 12"D	15	70
<b>AMS1248</b>	48"W x 12"D	22.25	75
<b>AMS1260</b>	60"W x 12"D	27.25	95
<b>AMS1272</b>	72"W x 12"D	32½	105
<b>AMS1824</b>	24"W x 18"D	15	70
<b>AMS1830</b>	30"W x 18"D	17.5	70
<b>AMS1836</b>	36"W x 18"D	20	70
<b>AMS1848</b>	48"W x 18"D	29.25	75
<b>AMS1860</b>	60"W x 18"D	35.00	95
<b>AMS1872</b>	72"W x 18"D	41	105





### WIRE CANTILEVER SHELF

PART NO.	DESCRIPTION	Wgt. (lbs)
WCS12-24	12"W/30.48cm x 60.96cm Fits 24" Upright System	5
WCS12-30	12"W/30.48cm x 76.20cm Fits 30" Upright System	6
WCS12-36	12"W/30.48cm x 91.44cm Fits 36" Upright System	7
WCS12-48	12"W/30.48cm x 121.92cm Fits 48" Upright System	9½
WCS12-60	12"W/30.48cm x 152.40cm Fits 60" Upright System	12
WCS12-72	12"W/30.48cm x 182.88cm Fits 72" Upright System	15

12" deep straight

#### 16" deep straight

PART NO.	DESCRIPTION	Wgt. (lbs)
WCS16-24	16"W/45.72cm x 60.96cm Fits 24" Upright System	6½
WCS16-30	16"W/45.72cm x 76.20cm Fits 30" Upright System	8
WCS16-36	16"W/45.72cm x 91.44cm Fits 36" Upright System	10
WCS16-48	16"W/45.72cm x 121.92cm Fits 48" Upright System	12½
WCS16-60	16"W/45.72cm x 152.40cm Fits 60" Upright System	16
WCS16-72	16"W/45.72cm x 182.88cm Fits 72" Upright System	21

16" deep straight

### SLANTED WIRE CANTILEVER SHELF

Same as WCS but set at slant 15°. Slanted shelf pricing includes steel front lip

PART NO.	12" deep slanted DESCRIPTION	Wgt. (lbs)
SWCS12-24	Slanted 12" W Fits 24" Upright Sys./30.48cm x 60.96cm	6
SWCS12-30	Slanted 12" W Fits 30" Upright Sys./30.48cm x 72.20cm	7
SWCS12-36	Slanted 12" W Fits 36" Upright Sys./30.48cm x 91.44cm	8
SWCS12-48	Slanted 12" W Fits 48" Upright Sys./30.48cm x 121.92cm	10
SWCS12-60	Slanted 12" W Fits 60" Upright Sys./30.48cm x 152.40cm	14
SWCS12-72	Slanted 12" W Fits 72" Upright Sys./30.48cm x 182.88cm	16

12" deep slanted

PART NO.	DESCRIPTION	Wgt. (lbs)
SWCS16-24	Slanted 16" W Fits 24" Upright Sys./45.72cm x 60.96cm	8
SWCS16-30	Slanted 16" W Fits 30" Upright Sys./45.72cm x 76.20cm	10
SWCS16-36	Slanted 16" W Fits 36" Upright Sys./45.72cm x 91.44cm	12
SWCS16-48	Slanted 16" W Fits 48" Upright Sys./45.72cm x 121.92cm	14
SWCS16-60	Slanted 16" W Fits 60" Upright Sys./45.72cm x 152.40cm	17
SWCS16-72	Slanted 16" W Fits 72" Upright Sys./45.72cm x 182.88cm	23

16" deep slanted

ACCESSORIES

- \*Fully adjustable to any height on the upright
- \*Wire design allows for better lighting and a dust free surface
- \*Durable Powder Coat Finish

### PULL OUT WRITING SHELF

Steel writing surface 12"W x 18"D. 30 lbs. capacity.



PART NO.	DESCRIPTION	Wgt. (lbs)	Wgt. (kgs)
POWS	Pull Out Shelf 12"W x 18"D 30.48cm x 45.72cm	12	5.45



Note:Both POWS and KOS require one HK Hanging Kit. Additional charge applies



Shelving and brackets available in textured black only.

### PULL OUT KEYBOARD

Powder coat painted steel

PART NO.	DESCRIPTION	Wgt. (lbs)	Wgt. (kgs)
KOS	Pull Out Keyboard Shelf 12"D x 19¾"L x 2.5 Clearance	16	7.2



### STANDARD LOWER SHELF

Heavy gauge formed shelf painted to match frame – 12" wide with a load capacity of 150 lbs.

Actual Depth 12"		Wgt. (lbs)	Wgt. (kgs)
PART NO.	DESCRIPTION		
HDLS48-12	12"W Fits 48"L Unit 30.48cm x 121.92 cm	15	6.8
HDLS60-12	12"W Fits 60"L Unit 30.48cm x 152.40 cm	18¾	8.5
HDLS72-12	12"W Fits 72"L Unit 30.48cm x 182.88 cm	22½	10.2
HDLS96-12	12"W Fits 96"L Unit 30.48cm x 243.84 cm	30	13.6

Actual Depth 18"		Wgt. (lbs)	Wgt. (kgs)
PART NO.	DESCRIPTION		
HDLS48-18	18"W Fits 48"L Unit 45.72cm x 121.92 cm	20	9
HDLS60-18	18"W Fits 60"L Unit 45.72cm x 152.40 cm	25	11.3
HDLS72-18	18"W Fits 72"L Unit 45.72cm x 182.88 cm	30	13.6
HDLS96-18	18"W Fits 96"L Unit 45.72cm x 243.84 cm	40	18.1



### FULL WIDTH LOWER SHELF

Steel painted to match frame, mounts at lower level.

Actual Depth 17.25"		Wgt. (lbs)	Wgt. (kgs)
PART NO.	DESCRIPTION		
FWLS48-24	24"W Fits 48"L Unit 60.96cm x 121.92 cm	25	11.3
FWLS60-24	24"W Fits 60"L Unit 60.96cm x 152.40 cm	31¼	14.2
FWLS72-24	24"W Fits 72"L Unit 60.96cm x 182.88 cm	37½	17
FWLS96-24	24"W Fits 96"L Unit 60.96cm x 243.84 cm	50	22.7

Actual Depth 23.25"		Wgt. (lbs)	Wgt. (kgs)
PART NO.	DESCRIPTION		
FWLS48-30	30"W Fits 48"L Unit 76.20cm x 121.92 cm	30	13.6
FWLS60-30	30"W Fits 60"L Unit 76.20cm x 152.40 cm	37½	17
FWLS72-30	30"W Fits 72"L Unit 76.20cm x 182.88 cm	45	20.4
FWLS96-30	30"W Fits 96"L Unit 76.20cm x 243.84 cm	60	27.2

Actual Depth 29.25"		Wgt. (lbs)	Wgt. (kgs)
PART NO.	DESCRIPTION		
FWLS48-36	36"W Fits 48"L Unit 91.44cm x 121.92 cm	35	15.9
FWLS60-36	36"W Fits 60"L Unit 91.44cm x 152.40 cm	43¾	19.8
FWLS72-36	36"W Fits 72"L Unit 91.44cm x 182.88 cm	52½	23.8
FWLS96-36	36"W Fits 96"L Unit 91.44cm x 243.84 cm	70	31.8

ACCESSORIES

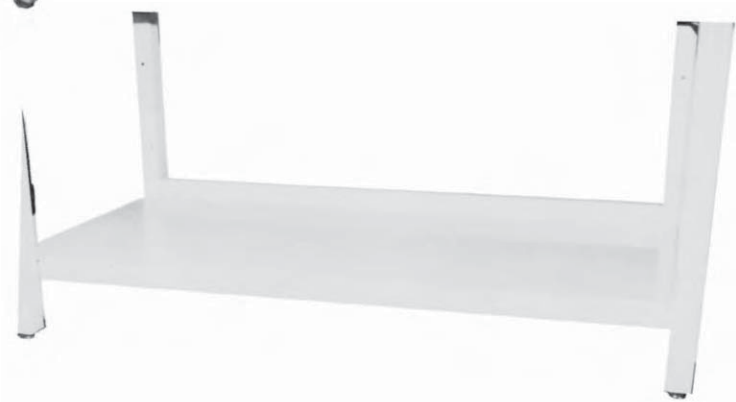

### TUBULAR INSTRUMENT SHELF

T mold plastic laminate shelf supported with heavy duty tubular steel frame.

Other heights available at an additional charge

PART NO.	DESCRIPTION	Wgt. (lbs)	Wgt. (kgs)
TIS1248	12"W x 48"L x 15"H 30.48cm x 121.92cm x 38.10cm	34	15.45
TIS1260	12"W x 60"L x 15"H 30.48cm x 152.40cm x 38.10cm	40½	18.41
TIS1272	12"W x 72"L x 15"H 30.48cm x 182.88cm x 38.10cm	47	21.36
TIS1296	12"W x 96"L x 15"H 30.48cm x 243.84cm x 38.10cm	60	27.27

PART NO.	DESCRIPTION	Wgt. (lbs)	Wgt. (kgs)
TIS1848	18"W x 48"L x 15"H 45.72cm x 121.92cm x 38.10cm	38	17.27
TIS1860	18"W x 60"L x 15"H 45.72cm x 152.40cm x 38.10cm	44½	20.23
TIS1872	18"W x 72"L x 15"H 45.72cm x 182.88cm x 38.10cm	51	23.18
TIS1896	18"W x 96"L x 15"H 45.72cm x 243.84cm x 38.10cm	64	29.09



# BINS

Proline offers a wide variety of bins and containers that are available in both standard and conductive. All have a common feature: they can be easily put on and taken off our bin holders and our louvered panels. **Sold in Cartons Only.** Standard Bin Colors: Blue, Red, Yellow, Ivory. Conductive Bins Black Only.

## Standard Bins

Part No.	Length	Width	Height	Capacity	Carton Qty.	Carton Wgt.
<b>BN-205</b>	4.5"	4.125"	3"	8	24	5
<b>BN-210</b>	5.5"	4.125"	3"	8	24	6
<b>BN-220</b>	7.5"	4.125"	3"	8	24	6
<b>BN-230</b>	11"	5.5"	5"	20	12	11
<b>BN-233</b>	13.5"	5.5"	5"	20	12	13
<b>BN-235</b>	11"	11"	5"	50	6	11
<b>BN-239</b>	11"	8.25"	7"	50	6	11
<b>BN-240</b>	14.750"	8.250"	7"	50	12	24
<b>BN-250</b>	14.750"	16.5"	7"	75	6	21
<b>BN-255</b>	16"	11"	8"	75	4	14
<b>BN-260</b>	18"	11"	10"	75	4	15
<b>BN-270</b>	18"	16.5"	11"	75	3	23



## Conductive Bins

Part No.	Length	Width	Height	Capacity	Carton Qty.	Carton Wgt.
<b>BN-205C</b>	4.5"	4.125"	3"	8	24	5
<b>BN-210C</b>	5.5"	4.125"	3"	8	24	6
<b>BN-220C</b>	7.5"	4.125"	3"	8	24	7
<b>BN-230C</b>	11"	5.5"	5"	20	12	12
<b>BN-233C</b>	13.5"	5.5"	5"	20	12	14
<b>BN-235C</b>	11"	11"	5"	50	6	15
<b>BN-239C</b>	11"	8.25"	7"	50	6	11
<b>BN-240C</b>	14.750"	8.250"	7"	50	12	25
<b>BN-250C</b>	14.750"	16.5"	7"	75	6	22
<b>BN-255C</b>	16"	11"	8"	75	4	15
<b>BN-260C</b>	18"	11"	10"	75	4	16
<b>BN-270C</b>	18"	16.5"	11"	75	3	18

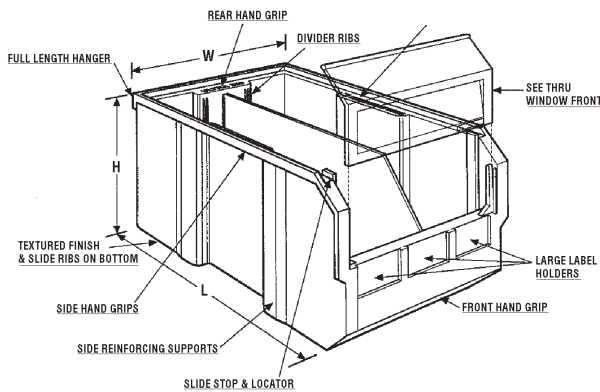

ACCESSORIES



## 0° - 30° WORK SURFACE TILT MECHANISM

Add to base price of station.

Often a tilted work surface allows operators to reduce lower back and arm fatigue. A front lip on the work surface keeps work in process on the table.

**Electric Tilt** – activated by push button or pedal.

**Hydraulic Tilt** – activated by hand crank

**Mechanical Tilt** – activated by lifting surface manually (13 positions)

*Tilt option must be purchased with initial bench order.*

PART NO.	DESCRIPTION	Wgt. (lbs)	Wgt. (cap)
<b>ET-1</b>	Electric Tilt	42	400
<b>HT-1</b>	Hydraulic Tilt	49	300
<b>MT-1</b>	Mechanical Tilt	25	75

### CORKBOARD TACK BOARD

Tack board corkboard front with white plastic laminate rear. T mold edges for clean finish look includes supports. Mounts to uprights.

PART NO.	DESCRIPTION	Wgt. (lbs)	Wgt. (cap)
TB24	24" x 12"	5.75	2.6
TB30	30" x 12"	7.25	3.3
TB36	36" x 12"	8	3.6
TB48	48" x 12"	9.25	4.2
TB60	60" x 12"	11	5
TB72	72" x 12"	13	5.9
TB96	96" x 12"	17	7.7



### SOLDER SPOOL HOLDER

Fits standard solder rolls. Also mounts onto Bin Holders.

PART NO.	DESCRIPTION	Wgt. (lbs)	Wgt. (kgs)
SH-1	Solder Spool Holder	.5	.22

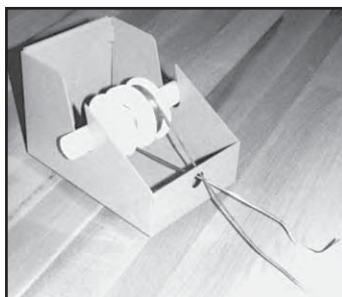

### ARTICULATING BIN HOLDER

17"H x 18"W locks in 2 positions. Bins optional. Extends up to 23.5" from upright.

Textured Black panel  
Frame of ABH to match work bench frame

PART NO.	DESCRIPTION	Wgt. (lbs)	Wgt. (cap)
ABH-1	Articulating Bin Holder	19	60



PART NO.	DESCRIPTION	Wgt. (lbs)	Wgt. (cap)
DP-1	15"L x 12"W x 12"H	13	65
DP-HK	mounting bracket	1	



### PAD LOCK DRAWER

Drawer with hasp for pad lock. Drawer features louvers for ventilation. Requires one **HK** mounting bracket per workstation. Part# **DP-HK**

### FREE STANDING FOOTREST

Adjustable for different size operators from 3" to 11".

PART NO.	DESCRIPTION	Wgt. (lbs)	Wgt. (cap)
T-20	Free Standing Footrest 12" x 20"	10	150

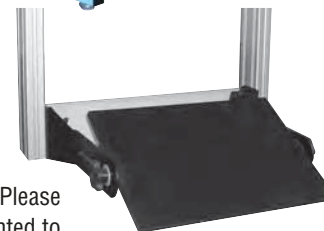

Suspends from bottom of frame Please specify model to be mounted to

Example: AT-20/HD **Attached Adjustable Footrest**

PART NO.	DESCRIPTION	Wgt. (lbs)	Wgt. (cap)
AT-20	Attached Footrest with 12" x 20" pan	35	75

### ARTICULATING MONITOR ARM

With 14" x 14" platform. Platform rotates 360°. Price includes clip on keyboard tray and mounting bracket. Extends up to 27.5" from upright. Up to 40 lbs. **For higher capacity see page 41.**

PART NO.	DESCRIPTION	Wgt. (lbs)	Wgt. (cap)
MA-1	Monitor Arm	19	50



ACCESSORIES

## TORQUE ARM / BALANCER AND STAND

Eliminate torque when powered assembly tools are activated!

36" Swing boom pivots on 60" column above worksurface. Provides full coverage for 60" x 30" worksurface.

- Pneumatic tool not included!

PART NO.	DESCRIPTION	Wgt. (lbs)
TQ-1	Torque Arm/Balancer	31



## FSMA FLAT SCREEN MONITOR ARM\*

75mm or 100mm Hole to Hole Mounting. FSMA extends up to 25" from the upright

PART NO.	DESCRIPTION	Wgt. (lbs)
FSMA	Flat Screen Monitor Arm	21
FSMAKBT	Adjustable Keyboard Tray	11



\*MONITOR AND KEYBOARD NOT INCLUDED  
AVAILABLE IN TEXTURED BLACK ONLY

ACCESSORIES

## 3 DIOPTER INSPECTION LIGHT

Requires Lomb from page 31 to mount to accessory uprights. Standard color Black.

PART NO.	DESCRIPTION	Wgt. (lbs)	Wgt. (cap)
MAG1	3 Diopter/45" Arm	9	N/A



## TOOL BALANCER

Balance out assembly tools so they weigh next to nothing!

PART NO.	DESCRIPTION	Wgt. (lbs)
TB-1	For tools weighing up to 1 lb	6
TB-5	For tools weighing up to 5 lbs	6



## TOOL HOLDER

Sits on worksurface or hangs on bin holder.

PART NO.	DESCRIPTION	Wgt. (lbs)	Wgt. (cap)
TH-1	Tool Holder	.5	.22



## UNDER SHELF PULL OUT KEYBOARD TRAY

Stores your keyboard under the shelf when not in use. Allows for more room on your work surface.

PART NO.	DESCRIPTION	Wgt. (lbs)
UPKT1248	12"D mounts to CSPL1248	12
UPKT1260	12"D mounts to CSPL1260	20
UPKT1272	12"D mounts to CSPL1272	32



## PIVOTING TOOL HOLDER

Mounts to our vertical uprights. Allows tool to be pivoted over work surface. Available in 18" and 24" lengths.

PART NO.	DESCRIPTION	Wgt. (lbs)
PTH18	Extends 18" from upright	4.5
PTH24	Extends 24" from upright	5.5

## BUILT IN LAZY SUSAN

Fits flush mount in any basic workstation. 18" diameter.

PART NO.	DESCRIPTION	Wgt. (lbs)	Wgt. (kgs)
LZ-1	Flush Mount Lazy Susan 18" Diameter	21	200

Must be ordered with initial purchase.

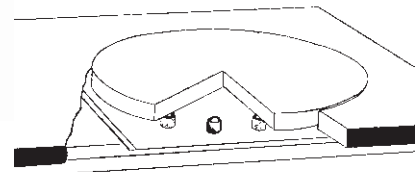

## CONVEYOR PALLETS

Custom sizes available upon request.  
For Standard Laminate add **PL** to Part #.  
For **ESD** Laminate add **ESD** to Part #.

PART NO.	DESCRIPTION	Wgt. (lbs)	Wgt. (cap)	Plastic Laminate	ESD Laminate
CP1824	18" x 24" x 3/4"	9	250	CP1824PL	CP1824ESD
CP2424	24" x 24" x 3/4"	12	250	CP2424PL	CP2424ESD
CP1836	18" x 36" x 3/4"	13.5	250	CP1836PL	CP1836ESD

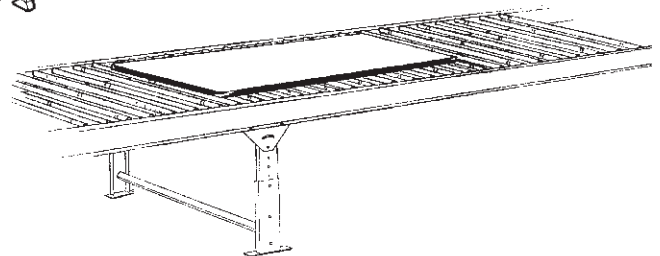
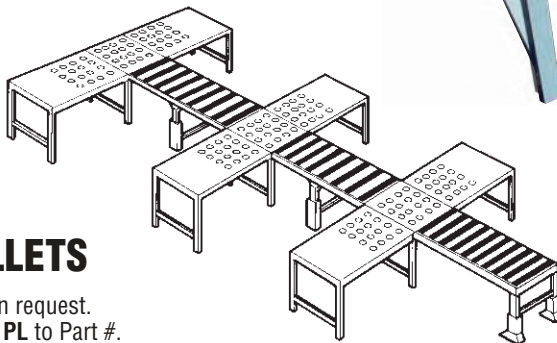

# MAKE YOUR WORKSTATION MOBILE... OR STATIONARY

## CASTERS TWO SWIVEL/TWO BRAKE

To mobilize workstations soft tread Polyurethane caster. 3" diameter wheel.

PART NO.	DESCRIPTION	Wgt. (lbs)	Wgt. (cap)
<b>C-4</b>	Stem Casters (set of 4) All swivel 2 with brake	4	400
<b>POC-4</b>	Stem Casters (set of 4) with polypropelene wheels All swivel 2 with brakes	4	400

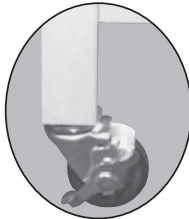

C-4



PC-4 Swivel

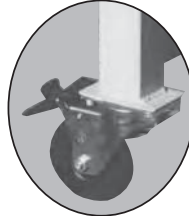

Total Lock

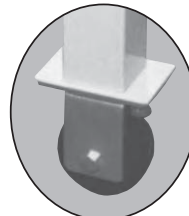

PC-4 Rigid

PART NO.	DESCRIPTION	Wgt. (lbs)	Wgt. (cap)
<b>PC-4</b>	Plate Casters 2 swivel with brake 2 rigid (set of 4)	5	400
<b>TLC-4</b>	Total Lock Casters a set of 4 4" casters locks both wheel and swivel. Plate style caster	6	400
<b>ELH POC-4</b>	For ELH Series only All Swivel	4	400

All Priced per set of four.

All casters feature Polyurethane wheels

## CASTER APPLICATIONS For Various Models

- C-4** Four leg workstations without leg extenders (can be added at any time) all four swivel. Models HD, TSHD, TW, PB, P, BT, GRBT. **Adds 3.25" to Height.**
- PC-4** Requires caster plates welded to station. Cantilever models, stations with HDLE-6, flexlines, 2 Swivel, 2 Rigid with brakes. **Adds 3.25" to Height.**
- TLC-4** Requires caster plates welded to station. All four have locks that locks both swivel and roll. Suggested uses EL, MVSII, and Modular cabinets. **Adds 4.25" to Height.**
- ELH POC-4** For ELH Series, All swivel Additional charges apply.

**PC-4, TLC-4 Must order at time of workstation purchase or they will require a mounting bracket that is available at an additional cost**  
**For non-stock benches, please specify the overall bench height**

## LAG PLATES

Affix your work bench to the floor



PART NO.	DESCRIPTION	Wgt. (lbs)	Wgt. (cap)
<b>LP</b>	Lag Plates (set of 4)	2	1000

ACCESSORIES



— For E.S.D. and/or many other caster options



## DUAL AXIS TOOL SUSPENSION FRAME

Trolleys on this tool suspension frame travel on both axis left to right and forward to rear. Frame extends 30" from upright. Price includes one tool trolley. Shown with UR72.

(Unit shown with torque arm priced on next graph.)

PART NO.	DESCRIPTION	Wgt. (lbs)
<b>DATSF48</b>	30" Deep x 48" Long	12
<b>DATSF60</b>	30" Deep x 60" Long	15
<b>DATSF72</b>	30" Deep x 72" Long	18
<b>DATSF96</b>	30" Deep x 96" Long	25

## TORQUE ARM

Torque Arm and Balancer to mount onto DATSF as shown. (DATSF sold separately.)

PART NO.	DESCRIPTION	Wgt. (lbs)
<b>TQ-2</b>	Torque Arm and Balancer for DATSF. Fits all length stations	5

### STEEL PEG BOARD

Steel Peg Boards painted to match frame. Mounts to Pro-Line upright system.



### HEAVY DUTY MONITOR ARM

Heavy Duty Monitor Arms feature a 14" x 14" platform. Used for monitors 40 lbs to 80 lbs.

PART NO.	DESCRIPTION	Wgt. (lbs)
HDMA-2	Heavy Duty Monitor Arm	24

PART NO.	DESCRIPTION	Wgt. (lbs)
SPB2448	24" High x 48" Long	8
SPB2460	24" High x 60" Long	10
SPB2472	24" High x 72" Long	12
SPB2496	24" High x 96" Long	16



### WIRE MANAGEMENT SYSTEM

Shown in photograph mounted vertically to our upright system. This flexible system can also be mounted horizontally to our upright system. Available in both 1.5" sq. and 2" sq. (Black) Lead free PVC. Priced in 6' long sections. We will cut to fit application. Example: For two pieces 36" long you need one 72" long piece, etc. (Please specify at time of order.)

PART NO.	DESCRIPTION	Wgt. (lbs)
WMS1.5	1.5" x 1.5" x 72" wire trough	3
WMS2	2" x 2" x 72" wire trough	4

### WIRE MANAGEMENT GROMMET

Mounts into work surface. Location varies between models.

PART NO.	DESCRIPTION	Wgt. (lbs)
WMG	Wire Management Grommet	0.25

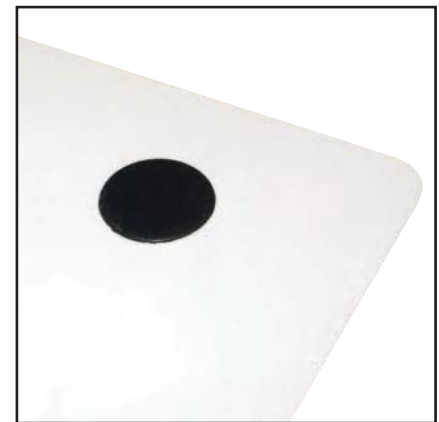

### SNAP-IN SLOT DESIGN and NON-SLIP COVER TYPE G

Material: PVC (Lead-Free)

- Restricted slot design
- Greater wire capacity
- Push duct and cover mating design
- No-slip cover

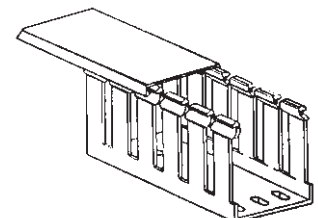



## EUROPEAN ELECTRICAL SUPPLIES

(250 VAC from 13 AMP to 16 AMP)

Various sockets and cable plugs to meet different country requirements.

PART NO.	DESCRIPTION	Wgt. (lbs)
EE525016A	5 outlets 250vac 16 amp 566.0cm x 51.6cm cord 2.5m continental Europe France/Belguim	1.18
EE525013D	4 outlets 250vac 13 amp 317.0cm x 68.0cm cord 2.5m United Kingdom/Ireland	0.69

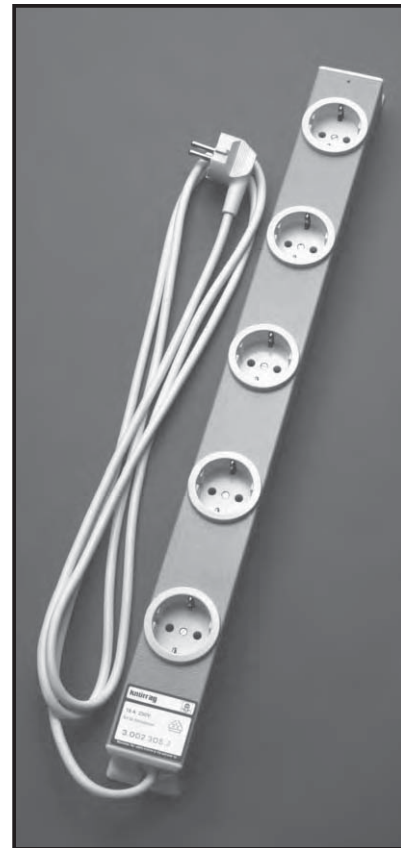

ACCESSORIES

## RETROFIT KIT

Pro-Line's retrofit kits are designed to turn a non-modular bench into a modular workstation. Simply set your legs to the same centers as Pro-Lines centers and you can mount any of our over worksurface accessories. Following is a guide on the outside dimensions of our accessories.

For a 48"L station 42.5"

For a 60"L station 54.5"

For a 72"L station 66.5"

For a 96"L station 87.5"

PART NO.	DESCRIPTION	Wgt. (lbs)
RK30	Retrofit Kit for a 30" deep worksurface	32
RK36	Retrofit Kit for a 36" deep worksurface	33



## E.S.D. GROUND KITS

PART NO.	DESCRIPTION	Wgt. (lbs)	Wgt. (kgs)
SGK-1	Standard Ground Kit	¼	.1
SGK-J2	Standard Ground Kit w/Banana Plug Jacks	½	.2
FGK-1	Flush Mount Ground Kit w/Jacks	½	.2
SGS-4	Standard Ground Wrist Strap 6' Cord	¼	.1

## WRIST STRAP



## CHATTER/PRIVACY SHIELDS

These shields are designed to mount to the back of our Heavy Duty Uprights. Shields are ideal to close off workstations from high traffic areas. Shields are available in both painted steel and plastic laminate. **To mount to our standard uprights drilling is required.**



ACCESSORIES

## GUARD RAIL

3" High painted steel guardrails meet in rear corners of work surface. Keeps small items from rolling off surface. Sold in set of one rear guard and two side guards. Mounts to top of work surface.



PART NO.	DESCRIPTION	WGT. (LBS)
<b>CPS48PL</b>	Chatter Shield for 48"L station Plastic Laminate 48" x 36"	35
<b>CPS60PL</b>	Chatter Shield for 60"L station. Plastic Laminate 60" x 36"	44
<b>CPS72PL</b>	Chatter Shield for 72"L station. Plastic Laminate 72" x 36"	53
<b>CPS48ST</b>	Chatter Shield for 48"L station. Painted Steel 48" x 36"	27
<b>CPS60ST</b>	Chatter Shield for 60"L station. Painted Steel 60" x 36"	44
<b>CPS72ST</b>	Chatter Shield for 72"L station. Painted Steel 72" x 36"	53

PART NO.	DESCRIPTION	WGT. (LBS)
<b>GR4830</b>	Guard Rail for 48" x 30" station	6
<b>GR4836</b>	Guard Rail for 48" x 36" station	8
<b>GR6030</b>	Guard Rail for 60" x 30" station	10
<b>GR6036</b>	Guard Rail for 60" x 36" station	12
<b>GR7230</b>	Guard Rail for 72" x 30" station	12
<b>GR7236</b>	Guard Rail for 72" x 36" station	14
<b>GR9630</b>	Guard Rail for 96" x 30" station	18
<b>GR9636</b>	Guard Rail for 96" x 36" station	20

# SECTION V

# PRO-LINE SEATING



**Model S8462**

## PRO-LINE SEATING

*3 to 4 week lead time for shipping*

If any component of your Pro-Line seating ever becomes defective, Pro-Line will repair or replace that chair for up to 12 years.

Pro-Line = best price and the best guarantee in seating.

All Pro-Line chairs are manufactured to meet or exceed California flammability code 117, BIFMA F-1-1978 and mvss302 standards

**Featuring:**

- Pneumatic height adjust - three ranges:
  0. Standard 18" - 24"
  1. Mid 20" - 27.5"
  2. High 24" - 33"
- Waterfall edge (leg comfort).
- 5 Star cast aluminum base.
- Glides come standard with all models.



**Model S8351**  
Shown with optional arms and casters



**Model S8350**  
Shown with optional casters

PRO-LINE SEATING

## HOW TO ORDER

### SEATING

Description	S Series Low Hgt.	Black Vinyl	Std Arm Rest, Breaking Caster
Example Part #	<b>S8350</b>	<b>9</b>	<b>8255,BC-5</b>
	Model	Upholstery	Optional Accessories

Example S835098255BC-5

### FRAMES

All models come standard with Chrome Frame and Polished Aluminum Base.

Colors\* See Inside Back Cover Color Chart

### UPHOLSTERY FABRIC/VINYL

<p><b>S Series Fabrics</b></p> <ol style="list-style-type: none"> <li>Burgundy</li> <li>Med Blue</li> <li>Royal Blue</li> <li>Navy Blue</li> <li>Beige</li> <li>Green</li> <li>Gray</li> <li>Black</li> </ol> <p><b>Vinyl</b></p> <ol style="list-style-type: none"> <li>Black</li> <li>Royal blue</li> </ol>
<p><b>E Series ESD Fabrics</b></p> <ol style="list-style-type: none"> <li>Slate Blue</li> <li>Navy Blue</li> <li>Gray</li> <li>Charcoal</li> </ol> <p><b>CLEAN ROOM ESD Vinyl</b></p> <ol style="list-style-type: none"> <li>Black</li> <li>Royal Blue</li> </ol>



Model S8350

Model S8351 With Optional Arms



Model S8462

### WATERFALL EDGE STANDARD TASK SEATING

SERIES	MODEL	HEIGHT RANGE	FOOT RING	Glides Standard	Casters Optional	Wgt. (lbs)
S	S8350	18" - 24"	optional	included	C-8, C7 & BC-5	31
	S8351	20" - 27.5"	included	included	C-8, C7 & BC-6	38
	S8352	24" - 33"	included	included	C-8, C7 & BC-5	38.5

### ESD SEATING

	MODEL	HEIGHT RANGE	FOOT RING	ESD Glides Standard	Casters Optional	Wgt. (lbs)
E	E8460	18" - 24"	optional	included	CC-8, CC7 & BCC-6	31
	E8461	20" - 27.5"	included	included	CC-8, CC7 & BCC-6	38
	E8462	24" - 33"	included	included	CC-8, CC7 & BCC-6	38.5

### CLASS 100 CLEANROOM SEATING

	MODEL	HEIGHT RANGE	FOOT RING	CR Glides Standard	Casters Optional	Wgt. (lbs)
CR	CR8570	18" - 24"	optional	included	C-8, C7 & BC-5	31
	CR8571	20" - 27.5"	included	included	C-8, C7 & BC-5	38
	CR8572	24" - 33"	included	included	C-8, C7 & BC-5	38.5

### OPTIONAL ACCESSORIES

CASTER OPTIONS	Model
Dual Wheel non braking carpet caster	C-8
Dual Wheel non braking hard floor caster	C-7
ESD Dual Wheel non braking carpet caster	CC-8
ESD Dual Wheel non braking hard floor caster	CC-7
Dual Wheel braking caster	BC-5
ESD Dual Wheel braking caster	BCC-6
ARM OPTIONS	
Standard Black	8255
ESD (E Only) Chrome	8256C
Foot Ring	FRACF-20

ESD Fabric is rated at 10<sup>6</sup> Ohms or less resistance

Glides come standard with ALL chairs

### OPTIONAL CASTERS

**C-8 Casters** – Ideal for carpeted floors.

**BC-5 Braking Casters** apply “brake” when seat is unoccupied – prevents seating from moving out from under operator during repeated sit/stand applications.

**CC8/CC7 Conductive Casters** for E and CR mobile ESD applications.

**BCC-6 Braking Conductive Casters** for E and CR Series. Used for mobile ESD applications on hard floors.

\*Caster prices vary when purchased separately

**CALL US TOLL FREE IF ADDITIONAL INFORMATION IS REQUIRED 1-800-739-9067**

# SECTION VI

# MATERIAL HANDLING PRODUCTS

## PORTABLE HYDRAULIC SCISSOR LIFTS

Six fully hydraulic models load rated from 300 lbs to 1500 lbs. Three height ranges to choose from. Foot pump or battery operation. Provide quick and effortless lifting and lowering. Use with our Mobile Retractable Ball Transfers. **Note:** Shown with optional MRBT. Pricing excludes retractable ball transfer platform.



Shown with hydraulic lift. Sold separately. Height is 7<sup>3</sup>/<sub>8</sub>". Pricing excludes mobile scissor lift.

PART NO.	CAPACITY	MAX. HEIGHT	PLATFORM SIZE	LOW HEIGHT	STROKES	Wgt. lbs
PSL-1	300	33"	20"W x 32"L	10"	12	250
PSL-2	600	33"	20"W x 32"L	10"	25	260
PSL-3	1000	33"	24"W x 36"L	9.25"	35	410
PSL-4	1500	33"	24"W x 36"L	9.25"	55	415
PSL-5	1000	45"	24"W x 48"L	9.25"	46	440
PSL-6	1500	45"	24"W x 48"L	9.25"	69	445
Battery Operated Lifts						
BPL-1	1000	33"	24"W x 36"L	9.25"	8 sec	470
BPL-2	1000	45"	24"W x 48"L	9.25"	14 sec	500

## MOBILE RETRACTABLE BALL TRANSFERS

These Retractable Ball Transfers are available with both lever and air operation. Our SD model has a 200 lb capacity with the transfers on a 6" x 6" pattern. Our HD model has a 500 lb capacity with the transfers on a 3" x 6" pattern.

### MOBILE RETRACTABLE BALL TRANSFER AIR OPERATED

PART NO.	DESCRIPTION	Wgt. (lbs)	Wgt. (kgs)
MRBT1824-ASD	18"W x 24"L 6x6 45.72cm x 60.96cm	56	25.4
MRBT2424-ASD	24"W x 24"L 6x6 60.96cm x 60.96cm	66	30
MRBT2430-ASD	24"W x 30"L 6x6 60.96cm x 76.20cm	78	35.4
MRBT2436-ASD	24"W x 36"L 6x6 60.96cm x 91.44cm	89	40.4
MRBT3030-ASD	30"W x 30"L 6x6 76.20cm x 76.20cm	88	40
MRBT3036-ASD	30"W x 36"L 6x6 76.20cm x 91.44cm	98	44.5
MRBT3636-ASD	36"W x 36"L 6x6 91.44cm x 91.44cm	106	48.1

### MOBILE RETRACTABLE BALL TRANSFER LEVER OPERATED

PART NO.	DESCRIPTION	Wgt. (lbs)	Wgt. (kgs)
MRBT1824-LSD	18"W x 24"L 6x6 45.72cm x 60.96cm	56	25.4
MRBT2424-LSD	24"W x 24"L 6x6 60.96cm x 60.96cm	66	30
MRBT2430-LSD	24"W x 30"L 6x6 60.96cm x 76.20cm	78	35.4
MRBT2436-LSD	24"W x 36"L 6x6 60.96cm x 91.44cm	89	40.4
MRBT3030-LSD	30"W x 30"L 6x6 76.20cm x 76.20cm	88	40
MRBT3036-LSD	30"W x 36"L 6x6 76.20cm x 91.44cm	98	44.5
MRBT3636-LSD	36"W x 36"L 6x6 91.44cm x 91.44cm	106	48.1

### HIGH DENSITY

PART NO.	DESCRIPTION	Wgt. (lbs)
MRBT1824-LHD	18"W x 24"L 3" x 6" pattern	65
MRBT2424-LHD	24"W x 24"L 3" x 6" pattern	76
MRBT2430-LHD	24"W x 30"L 3" x 6" pattern	88
MRBT2436-LHD	24"W x 36"L 3" x 6" pattern	99
MRBT3030-LHD	30"W x 30"L 3" x 6" pattern	98
MRBT3036-LHD	30"W x 36"L 3" x 6" pattern	108
MRBT3636-LHD	36"W x 36"L 3" x 6" pattern	116

### HIGH DENSITY

PART NO.	DESCRIPTION	Wgt. (lbs)
MRBT1824-AHD	18"W x 24"L 3" x 6" pattern	65
MRBT2424-AHD	24"W x 24"L 3" x 6" pattern	76
MRBT2430-AHD	24"W x 30"L 3" x 6" pattern	88
MRBT2436-AHD	24"W x 36"L 3" x 6" pattern	99
MRBT3030-AHD	30"W x 30"L 3" x 6" pattern	98
MRBT3036-AHD	30"W x 36"L 3" x 6" pattern	108
MRBT3636-AHD	36"W x 36"L 3" x 6" pattern	116

- (L) Lever Operated
- (A) Air Operated
- (SD) 6"x6" Standard Density
- (HD) 3"x6" High Density

Shown with hydraulic lift. Sold separately. Height is 7<sup>3</sup>/<sub>8</sub>". Pricing excludes mobile scissor lift.



MATERIALS HANDLING

## MODEL DIRBT (THE INLINE WORKSTATION)

Drop in RBT unit is the same construction as the work surface and ball grid of the RBT – with mounting rails matched to the inside frame dimension of your conveyor – when assembled, balls in up position match height of rollers. **Conveyor not included.** Shop air required.

PART NO.	DESCRIPTION	Wgt. (lbs)	Wgt. (kgs)
DIRBT2424SD	24"L x 24"W 6x6 BP 60.96cm x 60.96cm	58	26.3
DIRBT2430SD	24"L x 30"W 6x6 BP 60.96cm x 76.20cm	64	29
DIRBT2436SD	24"L x 36"W 6x6 BP 60.96cm x 91.44cm	88	40
DIRBT2448SD	24"L x 48"W 6x6 BP 60.96cm x 121.92cm	110	50
DIRBT2424HD	24"L x 24"W 3x6 BP 60.96cm x 60.96cm	69	31.3
DIRBT2430HD	24"L x 30"W 3x6 BP 60.96cm x 76.20cm	81	36.8
DIRBT2436HD	24"L x 36"W 3x6 BP 60.96cm x 91.44cm	109	49.5
DIRBT2448HD	24"L x 48"W 3x6 BP 60.96cm x 121.92cm	138	62.7



## LEAN MANUFACTURING (Point of use storage) Flow Racking

Store components at the point of use and eliminate materials handling. Includes two adjustable tiers of 48" long rollers. Each tier includes (3)- 9" wide rollers with front lip, additional tiers are available.

Show with optional light and power supply, see page 17 for more optional accessories



Please consult the factory for additional roller racks and other available sizes

Point of use storage flow racking with 60" x 30" surface that adjusts from 30" to 36" high. 65"H to 96.250 with adjustable cross members set all the way in.

Part Number	Plastic Laminate	ESD Laminate
POS6030	POS6030PL	POS6030ESD

Additional shelves for point of use storage flow racking include: Two lateral braces and three 9" wide rollers with front lip.

Part Number	Plastic Laminate	ESD Laminate
POSAS	NA	NA

## FLOW RACKING

Need to neatly organize and queue components?

Pull kits from your stock room and load the flow rack. Gravity flow will then feed your tote to station. Pro-Line's structural steel "U" channel frame allows you to set shelf at your required height. Use with a workstation or order optional laminate shelf and work off rack. 48"W x 36"D x 80"H.

Unit comes with two shelves, for additional shelves see chart below.



MATERIALS HANDLING

PART NO.	DESCRIPTION	WGT. (LBS)
FOR4836	Flow rack with two shelves 48"Wx36"Dx80"H	290
FORAS	Additional Shelf for rack 48"Wx36"D	105
FORCS1248	Cantilever Laminate Shelf For Flow Rack. 12"D x 48"W	25



### KITTING CART

Attractive, professional cart brings kits from stockroom to assembly. Totes included.

Tote size 16½" L x 11" W x 3½" H.  
Worksurface 24" W x 36" L x 38" H.  
Shelf size 9" W x 36" L.

PART NO.	DESCRIPTION	Wgt. (lbs)
KC-1	Kitting Cart	135

### TURN TABLES

Why run around your sub-assemblies? These turn tables allow you to stay seated while your product can be rotated 360° and lock into position at various intervals. 30" or 36" high. Please specify. Call for low profile models.

PART NO.	DESCRIPTION	Wgt. (lbs)
TT36	36" Dia. Table	110
TT48	48" Dia. Table	135



O.A.H.  
86.25"



### WORKSTATION FEED CART

Allows kits to be loaded at the stock room and wheeled into assembly. Gravity flow then feeds workstation. Call for custom sizes. Standard unit comes with two (2) 48" x 36" adjustable steel shelves at a 25° angle. Ball transfer shelves available upon request.

PART NO.	DESCRIPTION	Wgt. (lbs)
FC-1	Feed Cart	92
S4836	Additional Shelf	35



### THREE SHELF SERVICE TRUCK

48" High. Four swivel casters plus handle. Steel construction. Fixed height shelves.

PART NO.	DESCRIPTION	Wgt. (lbs)
ST1836	3 Shelf Truck 18" x 36"	84
ST1848	3 Shelf Truck 18" x 48"	100
ST2436	3 Shelf Truck 24" x 36"	100
ST2448	3 Shelf Truck 24" x 48"	133



### UTILITY CART

Utility Cart comes complete with two shelves and four casters two rigid and two swivel with brake. Painted steel construction. Height 30"

PART NO.	DESCRIPTION	Wgt. (lbs)
UT1824	Cart 18"W x 24"L	40
UT1836	Cart 18"W x 36"L	45
UT2424	Cart 24"W x 24"L	50
UT2436	Cart 24"W x 36"L	60

### BIN HOLDER CART

The Bin Holder Cart is an easy way to transport small parts. Comes complete as shown with 12 bin holders. Bin holders are adjustable on the open frame so you can configure cart as you need it.

PART NO.	DESCRIPTION	Wgt. (lbs)
BHC3648	Bin Holder Cart 36"W x 48"H	85
BHC4848	Bin Holder Cart 48"W x 48"H	98
BHC3666	Bin Holder Cart 36"W x 66"H	108
BHC4866	Bin Holder Cart 48"W x 66"H	115



MATERIALS HANDLING



### CANTILEVER SHELF CART

The Pro-Line Cantilever Shelf Cart comes complete with three shelves that are easily adjusted. The shelves are available in both standard laminate and ESD laminate. Price includes one set of casters with two swivel casters with brakes and two rigid casters. Shelves are 12" deep. Price also includes one fixed bottom shelf 18" deep.

PART NO.	DESCRIPTION	Wgt. (lbs)
CSC3648	Shelf Cart 36" L x 48" H	99
CSC4848	Shelf Cart 48" L x 48" H	123
CSC3660	Shelf Cart 36" L x 60" H	109
CSC4860	Shelf Cart 48" L x 60" H	133

### ADJUSTABLE TRAY / PCB CART

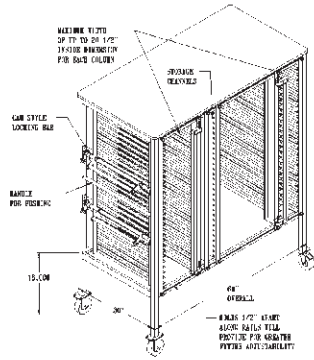



## MOBILE STORAGE CARTS

Configure the cart to meet your requirement. With Pro-Line's modular design it's easy. Start with our base cart and add the options you need. Carts are 24" wide and either 48" or 66" high. O.A.H. 55.250" or 73.250". Fully welded steel frames allow for infinite adjustability. Unit supplied with a set of casters, 2 rigid and 2 total lock.

PART NO.	DESCRIPTION	WGT. (LBS)
<b>MC2448</b>	Mobile Storage Cart 24"Wx48"H	82
<b>MC2466</b>	Mobile Storage Cart 24"Wx66"H	94



**Note:** Standard is that Carts roll left to right.

Swivel Casters Available at an additional cost



### OPTIONAL ACCESSORIES

PART NO.	DESCRIPTION	WGT. (LBS)
<b>CSPL1224FL</b>	Plastic Laminate Shelf 12"Wx24"L	12
<b>BH24FL</b>	Bin Holder 24"L	0.8
<b>LBP24FL</b>	Louvered Bin Panel	14
<b>SPB24FL</b>	Steel Pegboard 24"x24"	6
<b>ESMR24FL</b>	Electrical Supply Mounting Rail for 24"W Flexline	0.8
<b>ES12</b>	12" Power Supply	0.8

## REEL TRANSPORT CART

Transport and store reels of wire. Includes collars to captivate reels

PART NO.	DESCRIPTION	WGT. (LBS)
<b>RTC</b>	Reel Transport Cart	38



## REEL FEED CART

Wire spool holders mounted onto our mobile storage carts. Unit easily rolls behind a work station.

PART NO.	DESCRIPTION	WGT. (LBS)
<b>RFC</b>	Reel Feed Cart 24"W x 48"H	80



# SECTION VII

# WORKSURFACES

## PRO-LINE WORKSURFACES

Pro-Line has a variety of work surfaces to choose from. Pro-Line's standard work surface, and our most popular, is a plastic laminate surface with "T" mold edges. These surfaces are available in both standard and ESD laminate. With radius corners and "T" mold edges, it is durable, economical and worker friendly. For class 100 clean room and below we offer a self edge work surface. These surfaces are finished on all four sides with square edges that match the work surface. For added clean room protection we can laminate the bottom of our self edge work surfaces and our rolled front edge surfaces. Pro-Line also offers solid maple work surfaces. These work surfaces are 1.750" thick and both front and rear edges of the surface are eased for worker comfort. Our last standard work surface is a stainless steel 16 ga. 304 2B finish surface. They are 1.5" thick and both front and rear have an eased edge. Side edges are square. Should you need a work surface not listed here, feel free to give us a call. We also offer galvanized steel surfaces

Base Part No./ Size	Plastic Laminate .125	ESD Laminate .125	Solid Maple 1.75"	Chem Guard® 1.25"	HDPE 1"	Black Epoxy Resin 1"	Stainless Steel 1.25"
<b>WS4830</b> 48"x30"	<b>WS4830PL</b> Wgt. Lbs 45	<b>WS4830ESD</b> Wgt. Lbs 45	<b>WS4830SM</b> Wgt. Lbs 70	<b>WS4830CG</b> Wgt. Lbs 45	<b>WS4830HDPE</b> Wgt. Lbs 46	<b>WS4830ER</b> Wgt. Lbs 110	<b>WS4830SS</b> Wgt. Lbs 70
<b>WS4836</b> 48"x36"	<b>WS4836PL</b> Wgt. Lbs 54	<b>WS4836ESD</b> Wgt. Lbs 54	<b>WS4836SM</b> Wgt. Lbs 84	<b>WS4836CG</b> Wgt. Lbs 54	<b>WS4836HDPE</b> Wgt. Lbs 55	<b>WS4836ER</b> Wgt. Lbs 132	<b>WS4836SS</b> Wgt. Lbs 84
<b>WS6030</b> 60"x30"	<b>WS6030PL</b> Wgt. Lbs 56	<b>WS6030ESD</b> Wgt. Lbs 56	<b>WS6030SM</b> Wgt. Lbs 87	<b>WS6030CG</b> Wgt. Lbs 56	<b>WS6030HDPE</b> Wgt. Lbs 58	<b>WS6030ER</b> Wgt. Lbs 138	<b>WS6030SS</b> Wgt. Lbs 87
<b>WS6036</b> 60"x36"	<b>WS6036PL</b> Wgt. Lbs 68	<b>WS6036ESD</b> Wgt. Lbs 68	<b>WS6036SM</b> Wgt. Lbs 105	<b>WS6036CG</b> Wgt. Lbs 68	<b>WS6036HDPE</b> Wgt. Lbs 69	<b>WS6036ER</b> Wgt. Lbs 165	<b>WS6036SS</b> Wgt. Lbs 106
<b>WS7230</b> 72"x30"	<b>WS7230PL</b> Wgt. Lbs 68	<b>WS7230ESD</b> Wgt. Lbs 68	<b>WS7230SM</b> Wgt. Lbs 105	<b>WS7230CG</b> Wgt. Lbs 68	<b>WS7230HDPE</b> Wgt. Lbs 69	<b>WS7230ER</b> Wgt. Lbs 165	<b>WS7230SS</b> Wgt. Lbs 106
<b>WS7236</b> 72"x36"	<b>WS7236PL</b> Wgt. Lbs 81	<b>WS7236ESD</b> Wgt. Lbs 81	<b>WS7236SM</b> Wgt. Lbs 126	<b>WS7236CG</b> Wgt. Lbs 81	<b>WS7236HDPE</b> Wgt. Lbs 83	<b>WS7236ER</b> Wgt. Lbs 198	<b>WS7236SS</b> Wgt. Lbs 119
<b>WS9630</b> 96"x30"	<b>WS9630PL</b> Wgt. Lbs 90	<b>WS9630ESD</b> Wgt. Lbs 90	<b>WS9630SM</b> Wgt. Lbs 140	<b>WS9630CG</b> Wgt. Lbs 90	<b>WS9630HDPE</b> Wgt. Lbs 92	<b>WS9630ER</b> Wgt. Lbs 220	Special Order Call for Pricing
<b>WS9636</b> 96"x36"	<b>WS9636PL</b> Wgt. Lbs 108	<b>WS9636ESD</b> Wgt. Lbs 108	<b>WS9636SM</b> Wgt. Lbs 168	<b>WS9636CG</b> Wgt. Lbs 108	<b>WS9636HDPE</b> Wgt. Lbs 110	<b>WS9636ER</b> Wgt. Lbs 264	
<b>Edges</b>	<b>"T" Mold</b>	<b>"T" Mold</b>	<b>Eased</b>	<b>Square Edge</b>	<b>Eased Edge</b>	<b>Square Edge</b>	<b>Square Edge</b>

Light Shaded area "In Stock"

Note: ESD Surfaces require a grounding kit. See page 42

### ROLLED EDGE FOR STANDARD LAMINATE AND ESD LAMINATE SURFACES

Part No.	
<b>PF180</b>	<b>180° Rolled Front Edge</b>
<b>PF90</b>	<b>90° Rolled Front Edge</b>

**PF90 "In Stock"**

60"x 30" and 72"x 30"  
60"x 36" and 72"x 36"

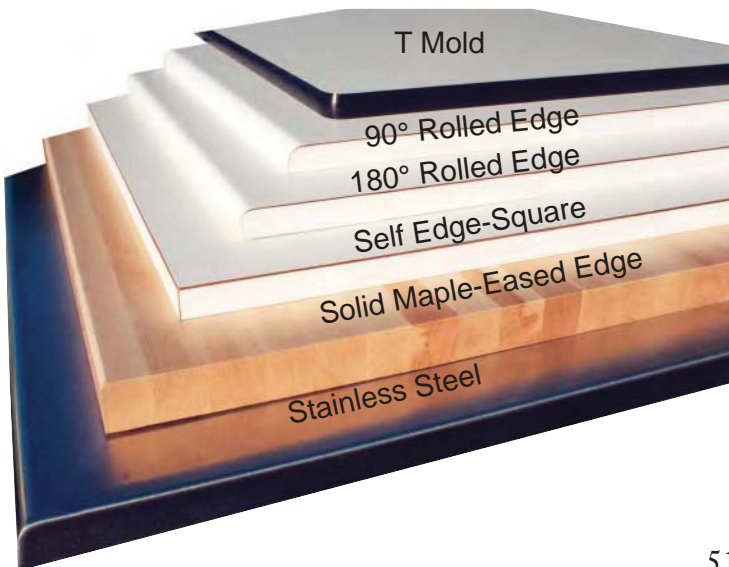
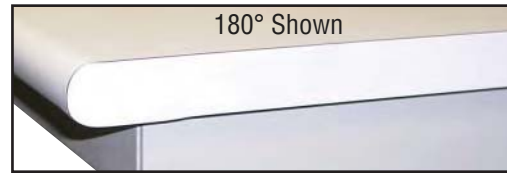

### GALVANIZED STEEL WORK SURFACE UPCHARGE

Add the letters GS to the end of our part number for the model you have chosen. **Note:** This Upcharge does not include RT or MRBT products. This applies to both, galvanized and stainless steel.

PART NO.	DESCRIPTION	Wgt. (lbs)
<b>4830GS</b>	48" x 30" Work Surface Up.	70
<b>4836GS</b>	48" x 36" Work Surface Up.	84
<b>6030GS</b>	60" x 30" Work Surface Up.	87
<b>6036GS</b>	60" x 36" Work Surface Up.	106
<b>7230GS</b>	72" x 30" Work Surface Up.	106
<b>7236GS</b>	72" x 36" Work Surface Up.	119

WORKSURFACES

SECTION VIII

**Pro-Lab** Series

**Modular Laboratory Furniture**

Available in Powder Coat Textured Finish Only



- Heavy Duty Modular Cabinets. 16 gauge steel
- 95% extension slides with 100 pounds capacity
- Recessed handles & Polished aluminum (recessed handle shown)

• Available in Powder Coat Textured Finish Only

Shown Two Tone Textured Blue & Textured Beige

- Pedestal drawers available with optional gang lock

Standard Textured Colors



Standard cabinets are 18" W x 27.5" H x 26" or 30" D Cabinet bases are available in three standard heights 3", 6", and 9". 1" adjustment with glide. Work surfaces vary from 1" to 1.75" thick.



Easily Configure your lab to meet your needs.



Mobile Cabinet bases are also available

Inside of drawers are designed to accept dividers every 1"



- Various Surfaces available
- Epoxy Resin
- Chem-Guard® "chemical resistant laminate"
- Colored laminates
  - ESD laminate
  - HDPE
  - Stainless steel
- Multi-tiered adjustable shelving
- Double or Single Swing Door Sink Base Stainless Steel sinks

• Modular Cabinets easily reconfigure drawer combinations







• All housings accept both drawers and swing doors



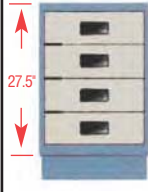



• Swing door cabinets include one adjustable shelf







• Adjustable glides for level installation



Heavy Duty Modular Cabinets **18" wide x (26" and 30" deep) x 27.5" high** ( without optional base)  
 Drawers feature 95% extension slides with 100 pounds capacity per drawer. Inside of drawers are slotted to accept optional dividers every 1" for optimal organization. Cabinet bases include leveling feet.

		Swing Door Right	Swing Door Left		Swing Door Right	Swing Door Left	
26"D	C4-626	C1-6-SDR26	C1-6-SDL26	C2-61-1226	CSDR26	CSDL26	C2-3-3-626
30"D	C4-630	C1-6-SDR30	C1-6-SDL30	C2-61-1230	CSDR30	CSDL30	C2-3-3-630
							
	6" Drawer (4x)	6" Drawer (1x) 18" Locker w/shelf (1x)	6" Drawer (1x) 18" Locker w/shelf (1x)	6" Drawer (2x) 12" Drawer (1X)	24" Locker w/shelf (1x)	24" Locker w/shelf (1x)	3" Drawer (2x) 6" Drawer (3x)
Wgt 26"	(118 lbs)	(87 lbs)	(87 lbs)	(111 lbs)	(76 lbs)	(76 lbs)	(122.50 lbs)
Wgt 30"	(132 lbs)	(99 lbs)	(99 lbs)	(125 lbs)	(87 lbs)	(87 lbs)	(136 lbs)

				Swing Door Right	Swing Door Left	Swing Door Right	Swing Door Left
26"D	C4-3-2-626	C2-1226	C8-326	C2-6-SDR26	C2-6-SDL26	C2-3-SDR26	C2-3-SDL26
30"D	C4-3-2-630	C2-1230	C8-330	C2-6-SDR30	C2-6-SDL30	C2-3-SDR30	C2-3-SDL30
							
	3" Drawer (4x) 6" Drawer (2x)	12" Drawer (2x)	3" Drawer (8x)	6" Drawer (2x) 12" Locker (1X)	6" Drawer (2x) 12" Locker (1X)	3" Drawer (2x) 18" Locker w/shelf (1x)	3" Drawer (2x) 18" Locker w/shelf (1x)
Wgt 26"	(127 lbs)	(104 lbs)	(136 lbs)	(95.5 lbs)	(95.5 lbs)	(91.5 lbs)	(91.5 lbs)
Wgt 30"	(141 lbs)	(118 lbs)	(152 lbs)	(107 lbs)	(107 lbs)	(102 lbs)	(102 lbs)

	Swing Door Right	Swing Door Left		Swing Door Right	Swing Door Left	CSB2SDRL Sink Base 36" wide double swing door (110lbs)	
26"D	C4-3-SDR26	C4-3-SDL26	C4-3-1-1226	C2-SDR26	C2-SDL26		
30"D	C4-3-SDR30	C4-3-SDL30	C4-3-1-1230	C2-SDR30	C2-SDL30		
							
	3" Drawer (4x) 12" Locker (1X)	3" Drawer (4x) 12" Locker (1X)	3" Drawer (4x) 12" Drawer (1X)	12" Locker (2X)	12" Locker (2X)		
Wgt 26"	(104.5 lbs)	(104.5 lbs)	(120 lbs)	(73 lbs)	(73 lbs)	CSB2SDRL26	26" Deep
Wgt 30"	(116 lbs)	(116 lbs)	(134 lbs)	(84 lbs)	(84 lbs)	CSB2SDRL30	30" Deep



Gang Locks Sold Separately for drawers  
 Part No. CGL  
 Swing door pricing includes lock.

Drawer Dividers	
Part No.	Wgt
3' DD3	(1.5) lbs
6' DD6	(2.5) lbs
12' DD12	(4.5) lbs

Galvanized Steel, see page 57 for other options

**Need A Mobile Unit\*?**  
 Add "M" to the end of the part#  
 Ex. CB3-26M  
 \*See page 40 for Casters  
 See page 57 for example

Cabinet Bases	
Part No. wgt	Description
CB3-26 (6 lbs)	3"H x 24"L O.A.H 30.5"
CB3-30 (7 lbs)	3"H x 28"L O.A.H 30.5"
CB6-26 (13 lbs)	6"H x 24"L O.A.H 33.5"
CB6-30 (15 lbs)	6"H x 28"L O.A.H 33.5"
CB9-26 (18 lbs)	9"H x 24"L O.A.H 36.5"
CB9-30 (21 lbs)	9"H x 28"L O.A.H 36.5"

### LAMINAR FLOW STATION “CLASS 100”



Modular free-standing unit. Operates on 120V 15 AMP electric. Other sizes and work surfaces available. Please consult factory.

- 99.99% efficient HEPA filter at .3 microns or larger.
- 1" disposable fiberglass prefilter.
- Variable speed control. Air velocity from 50-120 FPM.
- UL Approved.
- O.A.H. 80"
- Standard height of surface 30" H
- Surface enclosed on three sides.
- Quiet <65 db. motor

Base Part No./Size	PLASTIC LAMINATE		E.S.D. LAMINATE	
<b>CR483030</b>	<b>CR483030PL</b>		<b>CR483030ESD</b>	
48"L x 30"W x30"H	Wgt. (lbs) 225	Wgt. (cap) 600	Wgt. (lbs) 225	Wgt. (cap) 600
<b>CR603030</b>	<b>CR603030PL</b>		<b>CR603030ESD</b>	
60"L x 30"W x30"H	Wgt. (lbs) 281	Wgt. (cap) 600	Wgt. (lbs) 281	Wgt. (cap) 600
<b>CR723030</b>	<b>CR723030PL</b>		<b>CR723030ESD</b>	
72"L x 30"W x30"H	Wgt. (lbs) 330	Wgt. (cap) 600	Wgt. (lbs) 330	Wgt. (cap) 600

Work Surface is set at 30" High

- Part# CRRF Replacement Prefilters 12/case
- Part# CRHF Replacement HEPA filter
- Part# CROL Optional Clean Room light \*
- \*Must be ordered with station

### THE CR-MVSII HEIGHT ADJUSTABLE LAMINAR FLOW STATION “CLASS 100”

The CR-MVSII Height Adjustable Cleanroom Station combines two great Pro-line products: Our electric programmable height adjustable MVS and our CR class 100 clean room station. Unit adjusts from 30.5" to 46.5" via linear actuator with 100 pound capacity. HEPA filter specs are the same as Model CR above.

BASE PART NO. / SIZE	PLASTIC LAMINATE		E.S.D.		HDPE	
<b>CRMVSI4830</b>	<b>CRMVSI4830PL</b>		<b>CRMVSI4830ESD</b>		<b>CRMVSI4830HDPE</b>	
48"Lx30"W	Wgt. lbs 190	Wgt. Cap 1000	Wgt. lbs 190	Wgt. Cap 1000	Wgt. lbs 214	Wgt. Cap 1000
<b>CRMVSI4836</b>	<b>CRMVSI4836PL</b>		<b>CRMVSI4836ESD</b>		<b>CRMVSI4836HDPE</b>	
48"Lx36"W	Wgt. lbs 214	Wgt. Cap 1000	Wgt. lbs 214	Wgt. Cap 1000	Wgt. lbs 238	Wgt. Cap 1000
<b>CRMVSI6030</b>	<b>CRMVSI6030PL</b>		<b>CRMVSI6030ESD</b>		<b>CRMVSI6030HDPE</b>	
60"Lx30"W	Wgt. lbs 210	Wgt. Cap 1000	Wgt. lbs 210	Wgt. Cap 1000	Wgt. lbs 240	Wgt. Cap 1000
<b>CRMVSI6036</b>	<b>CRMVSI6036PL</b>		<b>CRMVSI6036ESD</b>		<b>CRMVSI6036HDPE</b>	
60"Lx36"W	Wgt. lbs 230	Wgt. Cap 1000	Wgt. lbs 230	Wgt. Cap 1000	Wgt. lbs 272	Wgt. Cap 1000
<b>CRMVSI7230</b>	<b>CRMVSI7230PL</b>		<b>CRMVSI7230ESD</b>		<b>CRMVSI7230HDPE</b>	
72"Lx30"W	Wgt. lbs 230	Wgt. Cap 1000	Wgt. lbs 230	Wgt. Cap 1000	Wgt. lbs 272	Wgt. Cap 1000
<b>CRMVSI7236</b>	<b>CRMVSI7236PL</b>		<b>CRMVSI7236ESD</b>		<b>CRMVSI7236HDPE</b>	
72"Lx36"W	Wgt. lbs 250	Wgt. Cap 1000	Wgt. lbs 250	Wgt. Cap 1000	Wgt. lbs 292	Wgt. Cap 1000



Shown with optional CROL Clean Room light.

# DIMENSION NEXT

## LABORATORY MODULAR TECHNICAL SYSTEMS



The Model DNL offers esthetics, flexible modularity and ergonomics. Designed with work surfaces and frames that give you the ultimate laboratory work station. Easily add and adjust optional accessories to meet your needs.

Work surfaces adjust vertically anywhere on the aluminum upright allowing increased operator comfort and production.

Pro-line's overhead cabinets and under-surface modular cabinets allow you to neatly organize and utilize work space.

Optional task lighting, shown mounted under sliding door cabinet, reduces worker fatigue yet takes up very little space

The DNL uses the same frame design as the standard Dimension Next allowing you to save money and space with double-sided units and add-on units.

- Single-sided starter station includes two uprights, two horizontal leg supports, one top frame assembly and one work surface.
- Single-sided add-on station includes one upright, one horizontal leg support, one top frame assembly and one surface.
- Double-sided starter station includes two uprights, two back-to-back horizontal leg supports, two top frame assemblies and two work surfaces.
- Double-sided add-on station includes one upright, one back-to-back horizontal leg support, two top frame assemblies and two work surfaces.

Shown with optional accessories

### Single Sided Starter

Base Part No./Size	Epoxy Resin	H.D.P.E.
<b>DNL4830SS</b> 48"L x 30"W <b>Single Starter</b>	<b>DNL4830SSER</b> 48"L x 30"W Wgt. (lbs) 177	<b>DNL4830SSHDPE</b> 48"L x 30"W Wgt. (lbs) 177
<b>DNL6030SS</b> 60"L x 30"W <b>Single Starter</b>	<b>DNL6030SSER</b> 60"L x 30"W Wgt. (lbs) 198	<b>DNL6030SSHDPE</b> 60"L x 30"W Wgt. (lbs) 198
<b>DNL7230SS</b> 72"L x 30"W <b>Single Starter</b>	<b>DNL7230ER</b> 72"L x 30"W Wgt. (lbs) 217	<b>DNL7230SSHDPE</b> 72"L x 30"W Wgt. (lbs) 217

### Double Sided Starter

Base Part No./Size	Epoxy Resin	H.D.P.E.
<b>DNL4830DS</b> 48"L x 30"W <b>Double Starter</b>	<b>DNL4830DSER</b> 48"L x 30"W Wgt. (lbs) 280	<b>DNL4830DSHDPE</b> 48"L x 30"W Wgt. (lbs) 280
<b>DNL6030DS</b> 60"L x 30"W <b>Double Starter</b>	<b>DNL6030DSER</b> 60"L x 30"W Wgt. (lbs) 307	<b>DNL6030DSHDPE</b> 60"L x 30"W Wgt. (lbs) 307
<b>DNL7230DS</b> 72"L x 30"W <b>Double Starter</b>	<b>DNL7230DSER</b> 72"L x 30"W Wgt. (lbs) 317	<b>DNL7230DSHDPE</b> 72"L x 30"W Wgt. (lbs) 317

### Single Sided Add-on

Base Part No./Size	Epoxy Resin	H.D.P.E.
<b>DNL4830SA</b> 48"L x 30"W <b>Single Add-on</b>	<b>DNL4830SAER</b> 48"L x 30"W Wgt. (lbs) 130	<b>DNL4830SAHDPE</b> 48"L x 30"W Wgt. (lbs) 130
<b>DNL6030SA</b> 60"L x 30"W <b>Single Add-on</b>	<b>DNL6030SAER</b> 60"L x 30"W Wgt. (lbs) 148	<b>DNL6030SAHDPE</b> 60"L x 30"W Wgt. (lbs) 148
<b>DNL7230SA</b> 72"L x 30"W <b>Single Add-on</b>	<b>DNL7230SAER</b> 72"L x 30"W Wgt. (lbs) 168	<b>DNL7230SAHDPE</b> 72"L x 30"W Wgt. (lbs) 168

### Double Sided Add-on

Base Part No./Size	Epoxy Resin	H.D.P.E.
<b>DNL4830DA</b> 48"L x 30"W <b>Double Add On</b>	<b>DNL4830DAER</b> 48"L x 30"W Wgt. (lbs) 220	<b>DNL4830DAHDPE</b> 48"L x 30"W Wgt. (lbs) 220
<b>DNL6030DA</b> 60"L x 30"W <b>Double Add On</b>	<b>DNL6030DAER</b> 60"L x 30"W Wgt. (lbs) 260	<b>DNL6030DAHDPE</b> 60"L x 30"W Wgt. (lbs) 260
<b>DNL7230DA</b> 72"L x 30"W <b>Double Add On</b>	<b>DNL7230DAER</b> 72"L x 30"W Wgt. (lbs) 300	<b>DNL7230DAHDPE</b> 72"L x 30"W Wgt. (lbs) 300

For Additional information on this system  
See pages 14 and 15

**The Model LHD** is a four leg bench design built on the Model HD frame but modified to a standard height of 34". The footrest is mounted low on the leg to allow space for our modular cabinets. Easily add casters, cabinets or other modular accessories and design your own mobile lab bench, see page 57 for more details. Price includes modesty panel. 5000 pound capacity with evenly distributed weight.

BASE PART NO./SIZE	STAINLESS STEEL	EPOXY RESIN	CHEM-GUARD®
<b>LHD603034</b>	<b>LHD603034SS</b>	<b>LHD603034ER</b>	<b>LHD603034CG</b>
60"L x 30"W	Wgt. (lbs) 146	Wgt. (lbs) 255	Wgt. (lbs) 115
<b>LHD723034</b>	<b>LHD723034SS</b>	<b>LHD723034ER</b>	<b>LHD723034CG</b>
72"L x 30"W	Wgt. (lbs) 168	Wgt. (lbs) 263	Wgt. (lbs) 130
<b>LHD603634</b>	<b>LHD603634SS</b>	<b>LHD603634ER</b>	<b>LHD603634CG</b>
60"L x 36"W	Wgt. (lbs) 163	Wgt. (lbs) 255	Wgt. (lbs) 125
<b>LHD723634</b>	<b>LHD723634SS</b>	<b>LHD723634ER</b>	<b>LHD723634CG</b>
72"L x 36"W	Wgt. (lbs) 225	Wgt. (lbs) 355	Wgt. (lbs) 135



**The Model LHD**

**The Model HDL** is a sturdy four leg design station. Features include 4" front, back and side rails to support the work surface. 4" high rail allows operator to sit at both sides. Price also includes PVC boot for each leg to protect station during clean ups. Standard height 30" high. Additional charge for other heights



**The Model HDL**

BASE PART NO./SIZE	STAINLESS STEEL	EPOXY RESIN	CHEM-GUARD®
<b>HDL4830</b>	<b>HDL483030SS</b>	<b>HDL483030ER</b>	<b>HDL483030CG</b>
48"L x 30"W	Wgt. (lbs) 130	Wgt. (lbs) 187	Wgt. (lbs) 100
<b>HDL4836</b>	<b>HDL483630SS</b>	<b>HDL483630ER</b>	<b>HDL483630CG</b>
48"L x 36"W	Wgt. (lbs) 138	Wgt. (lbs) 212	Wgt. (lbs) 108
<b>HDL6030</b>	<b>HDL603030SS</b>	<b>HDL603030ER</b>	<b>HDL603030CG</b>
60"L x 30"W	Wgt. (lbs) 146	Wgt. (lbs) 224	Wgt. (lbs) 115
<b>HDL6036</b>	<b>HDL603630SS</b>	<b>HDL603630ER</b>	<b>HDL603630CG</b>
60"L x 36"W	Wgt. (lbs) 163	Wgt. (lbs) 255	Wgt. (lbs) 125
<b>HDL7230</b>	<b>HDL723030SS</b>	<b>HDL723030ER</b>	<b>HDL723030CG</b>
72"L x 30"W	Wgt. (lbs) 168	Wgt. (lbs) 263	Wgt. (lbs) 130
<b>HDL7236</b>	<b>HDL723630SS</b>	<b>HDL723630ER</b>	<b>HDL723630CG</b>
72"L x 36"W	Wgt. (lbs) 530	Wgt. (lbs) 530	Wgt. (lbs) 530

**The Model HDSS** incorporates the design of the model HD four-leg station in use since 1978. However, it features a stainless steel frame. Able to ship knocked down or fully assembled with three standard work surfaces offered: Stainless Steel, Epoxy Resin or Chem- Guard® chemical resistant laminate. With an 8" backrail and 2" front rail, this station is built to last. Standard height 30"

BASE PART NO./SIZE	STAINLESS STEEL	EPOXY RESIN	CHEM-GUARD®
<b>HDSS4830</b>	<b>HDSS483030SS</b>	<b>HDSS483030ER</b>	<b>HDSS483030CG</b>
48"L x 30"W	Wgt. (lbs) 140	Wgt. (lbs) 191	Wgt. (lbs) 110
<b>HDSS4836</b>	<b>HDSS483630SS</b>	<b>HDSS483630ER</b>	<b>HDSS483630CG</b>
48"L x 36"W	Wgt. (lbs) 148	Wgt. (lbs) 222	Wgt. (lbs) 118
<b>HDSS6030</b>	<b>HDSS603030SS</b>	<b>HDSS603030ER</b>	<b>HDSS603030CG</b>
60"L x 30"W	Wgt. (lbs) 156	Wgt. (lbs) 234	Wgt. (lbs) 125
<b>HDSS6036</b>	<b>HDSS603630SS</b>	<b>HDSS603630ER</b>	<b>HDSS603630CG</b>
60"L x 36"W	Wgt. (lbs) 173	Wgt. (lbs) 265	Wgt. (lbs) 135
<b>HDSS7230</b>	<b>HDSS723030SS</b>	<b>HDSS723030ER</b>	<b>HDSS723030CG</b>
72"L x 30"W	Wgt. (lbs) 178	Wgt. (lbs) 273	Wgt. (lbs) 140
<b>HDSS7236</b>	<b>HDSS723630SS</b>	<b>HDSS723630ER</b>	<b>HDSS723630CG</b>
72"L x 36"W	Wgt. (lbs) 195	Wgt. (lbs) 307	Wgt. (lbs) 150



## Architects and Facility Engineers

Send us a copy of your layout for details and pricing...

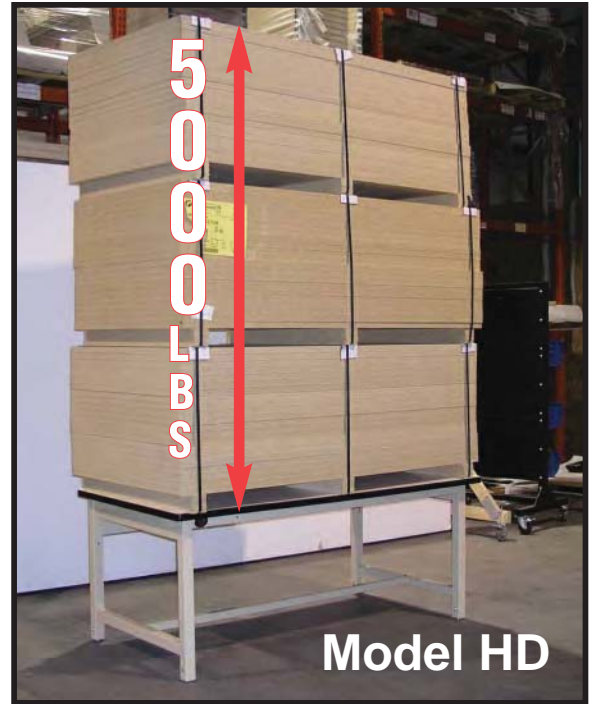
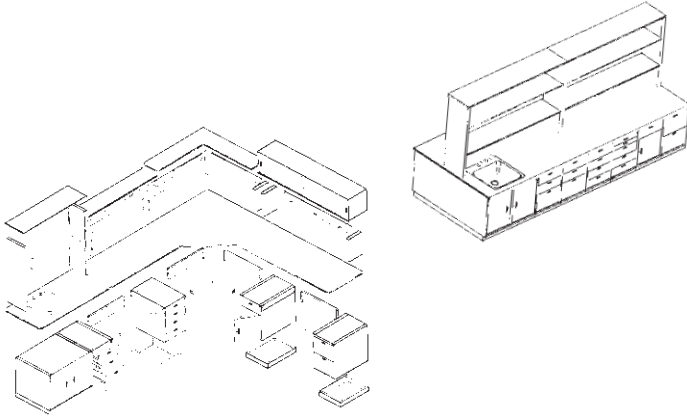

5,000 lbs capacity load test.

## Sample Configurations



Mobile cabinet base



Optional ESD/UHMW Drawer dividers available in a variety of configurations  
Please call for details and reference part no.

# How to design your own modular lab bench

- A...Choose a base**  
Need options above the surface?
- B...Select uprights**  
Going mobile?
- C...Select casters**  
Need a footrest?
- D...Select footrest**  
Require under surface storage?
- E/F...Select drawers or cabinets**  
Need power?
- G/H...Choose power supply**  
Need under shelf lighting?
- I...Select a light**  
Need overhead storage?
- J...Select a cabinet or shelving**  
Need wire management?
- K...Select a wire trough**



Model #	Page#
LHD603034CG.....	56 <b>A</b>
UR60.....	27 <b>B</b>
TLC-4.....	40 <b>C</b>
FR60.....	29 <b>D</b>
C1-6-SDL26.....	53 <b>E</b>
C1-6-SDR26.....	53 <b>F</b>
ESMR60.....	29 <b>G</b>
ES48.....	29 <b>H</b>
LT48.....	28 <b>I</b>
SDC60/SGLD.....	31 <b>J</b>
WMS1.5.....	41 <b>K</b>





## PAINTED STEEL COLORS

### POWDER COAT PAINTED STEEL FRAMES AND ACCESSORIES

Pro-Line Standards

LIGHT BEIGE LIGHT BLUE LIGHT GRAY

F63H11

F63L14

F63A31

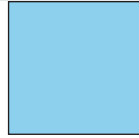
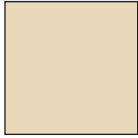

All Other Colors are Available at an Additional Charge

Textured White RFW627

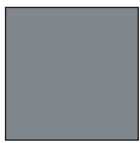

Dark Gray  
F63A13



Dark Blue  
F63L16



Gloss Black  
F63B12

### Standard DIMENSION NEXT COLORS



Textured  
Black  
505T2



Textured  
Beige  
530T2

### Modular Cabinet Housings-Textured



Standard  
Soft Blue  
607T3

Also available in these colors  
at an upcharge, Gray PLH606  
White RFW627 & Black 505T2

### Standard FOR BASICS MODEL



Textured  
Black  
505T2



Dark Blue  
F63L16

### ESD PAINT



Available  
\*Call for pricing

## WORK SURFACE COLORS

### PLASTIC LAMINATE TOP COLORS

Pro-Line Standard  
WHITE SW806



\*Other Colors Available at an Additional charge



\*Black  
SE101



\*Royal Blue  
SB009



\*Beige  
ST617



\*French  
Blue  
SB005



\*Mercury  
(Lt.Gray)  
SG204

### ESD PLASTIC LAMINATE

Pro-Line Standard  
WHITE SW837



For stainless steel, perforated, chemical resistant  
lab tops or any other tops please consult factory.

\*Other Colors Available at an Additional charge



\*Beige  
S-2-64



\*Light Blue  
S-3-35



\*Dove Gray  
SG248

## WORK SURFACE T-MOLD EDGES

Pro-Line Standard  
BLACK



\*Other Colors Available at an Additional charge



\*Brown



\*White



\*Gray

Self Edged Tops Available at an Additional charge per Edge

## ROHS COMPLIANT

Identify an area as "Lead Free"  
Have your painted steel, frames  
and accessories painted green  
at no extra charge Part# PGS8



## SEATING COLOR OPTIONS

See Pages 44 and 45  
for Seating

### Standard Fabrics and Vinyls

#### Standard Fabrics

1 Burgundy	2 Medium Blue	3 Royal Blue	4 Navy Blue	5 Beige	6 Green	7 Gray	8 Black
---------------	------------------	-----------------	----------------	------------	------------	-----------	------------



#### Standard Vinyls

15 Black	16 Royal Blue
-------------	------------------

11 Slate Blue	12 Navy Blue	13 Gray	14 Charcoal
------------------	-----------------	------------	----------------

### Static Control Fabric

All models come with Chrome Frame  
and Polished Aluminum Base

Note: Due to printing limitations, color on this page may vary slightly  
from actual color. Please consult with your Pro-line representative to  
see actual paint, laminate or fabric samples if color is critical.